

Firetox

LSZH Flame Retardant Instrumentation & Data Cables

www.caledonian-cables.co.uk www.addison-cables.com



Caledonian

TABLE OF CONTENTS

- 01/** LSZH Flame Retardant Overall Screened Instrumentation Cables (Multicore)
- 07/** LSZH Flame Retardant Overall Screened, Armoured Instrumentation Cables (Multicore)
- 13/** LSZH Flame Retardant Overall Screened Instrumentation Cables (Multipair)
- 18/** LSZH Flame Retardant Individual and Overall Screened Instrumentation Cables (Multipair)
- 23/** LSZH Flame Retardant Overall Screened, Armoured Instrumentation Cables (Multipair)
- 29/** LSZH Flame Retardant Individual and Overall Screened, Armoured Instrumentation Cables (Multipair)
- 34/** LSZH Flame Retardant CAT5E Data Cables
- 37/** LSZH Flame Retardant CAT5E CWB/SWB/SWA Armoured Data Cables
- 40/** LSZH Flame Retardant CAT6 Data Cables
- 43/** LSZH Flame Retardant CAT6 CWB/SWB/SWA Armoured Data Cables
- 46/** LSZH Flame Retardant RS485 Databus Cables
- 51/** Type Codes
- 52/** Technical Information for Fire Properties



LSZH Flame Retardant Overall Screened Instrumentation Cables (Multicore)

RE-2X(St)H

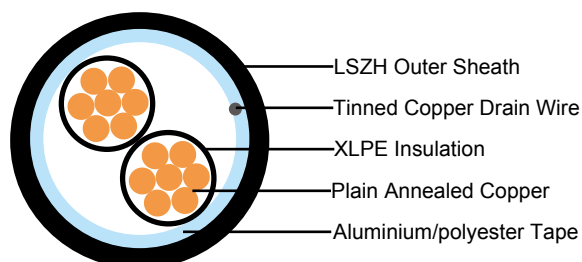

APPLICATION

The LSZH sheathed cables are generally used for indoor installation and suitable for wet and damp areas. Generally, the cables are used within industrial process manufacturing plants for communication, data and voice transmission signals and services. Also used for the interconnection of electrical equipment and instruments, the LSZH sheath can reduce toxic smoke and fume emission. This product type is TUV approved.

STANDARDS

Basic design to BS EN 50288-7 (formerly BS 5308)



Approvals:

TUV Certification (Z1 17 12 98200 014)

FIRE PERFORMANCE

Flame Retardance (Single vertical wire or cable test)	IEC 60332-1-2; EN 60332-1-2
Reduced Fire Propagation (Vertically-mounted bundled wires & cables test)	IEC 60332-3-24; EN 60332-3-24
Halogen Free	IEC 60754-1; EN 50267-2-1
No Corrosive Gas Emission	IEC 60754-2; EN 50267-2-2
Minimum Smoke Emission	IEC 61034-2; EN 61034-2

VOLTAGE RATING

300, 500V

CABLE CONSTRUCTION

Conductor: Plain or metal coated copper wire, solid, stranded or flexible according to IEC 60228 class 1, 2 and 5.

Insulation: Extruded XLPE compound according to EN 50290-2-29. LSZH, PE, PP compound can be offered as options.



Caledonian

FIRETOX LSZH Flame Retardant Instrumentation & Data Cables

www.caledonian-cables.co.uk www.addison-cables.com

Overall Screen: Aluminium/polyester tape is applied over the laid up cores with metallic side down in contact with tinned copper drain wire, 0.5mm². Copper braid screen or aluminium/polyester tape combined with copper braid screen can be offered as option.

Outer Sheath: Halogen free flame retardant compound to EN 50290-2-27.

Outer Sheath Option: UV resistance, hydrocarbon resistance, oil resistance, anti-rodent and anti-termite properties can be offered as option.

COLOUR CODE

Insulation Colour: Colours and/or additional ring markings and/or symbols achieved by the use of coloured insulation or by a coloured surface using extrusion, printing or painting.

Outer Sheath: Black. Other colours can be offered upon request.

PHYSICAL AND THERMAL PROPERTIES

Temperature range during operation: -30°C - +90°C

Temperature range fixed installation: -5°C - +50°C

Maximum short circuit temperature (5 Seconds): 250°C

Minimum bending radius: 7.5 x Overall Diameter

ELECTRICAL PROPERTIES

300V

Conductor Area Size	mm ²	0.5	0.75	1.0	1.5
Insulation Thickness (Nominal)	mm	0.4	0.4	0.4	0.5
Insulation Thickness (Minimum)	mm	0.26	0.26	0.26	0.35
Conductor Resistance (20°C)	ohm/km	36.7	25.0	18.5	12.3
Minimum Insulation Resistance (20°C)	Mohm/km	1000			
Maximum Mutual Capacitance	nf/km	250			
Capacitance Unbalance	pf/500m	500			
Maximum L/R (ratio)	μH/Ω	25	25	25	40
Operating Voltage	V	300			
Dielectric Strength for 1 Minute	AC	V	≥1000		
	DC	V	≥2000		

500V

Conductor Area Size	mm ²	0.5	0.75	1.0	1.5	2.5
Insulation Thickness (Nominal)	mm	0.6	0.6	0.6	0.6	0.7
Insulation Thickness (Minimum)	mm	0.44	0.44	0.44	0.44	0.53
Conductor Resistance (20°C)	ohm/km	36.7	25.0	18.5	12.3	7.4
Minimum Insulation Resistance (20°C)	Mohm/km	1000				
Maximum Mutual Capacitance	nf/km	250				

Capacitance Unbalance		pf/500m	500				
Maximum L/R (ratio)		$\mu\text{H}/\Omega$	25	25	25	40	60
Operating Voltage		V	500				
Dielectric Strength for 1 Minute	AC	V	≥ 2000				
	DC	V	≥ 3000				

CONSTRUCTION PARAMETERS

300V

Conductor		RE-2X(St)H			
No. of Core X Cross Section	Class of Conductor	Nominal Insulation Thickness	Nominal Sheath Thickness	Approx. Overall Diameter	Approx. Weight
mm^2		mm	mm	mm	kg/km
0.5mm²					
2x0.5	2	0.4	0.9	5.5	44
3x0.5	2	0.4	0.9	5.7	54
4x0.5	2	0.4	0.9	6.2	64
5x0.5	2	0.4	0.9	6.7	75
8x0.5	2	0.4	1.0	7.9	108
10x0.5	2	0.4	1.0	9.1	132
12x0.5	2	0.4	1.0	9.4	149
14x0.5	2	0.4	1.0	9.8	167
16x0.5	2	0.4	1.0	10.3	185
20x0.5	2	0.4	1.1	11.3	228
24x0.5	2	0.4	1.1	12.8	269
27x0.5	2	0.4	1.1	13.0	293
30x0.5	2	0.4	1.2	13.7	327
37x0.5	2	0.4	1.2	14.7	388
40x0.5	2	0.4	1.2	15.2	415
0.75mm²					
2x0.75	2	0.4	0.9	5.8	52
3x0.75	2	0.4	0.9	6.1	64
4x0.75	2	0.4	0.9	6.6	77
5x0.75	2	0.4	1.0	7.4	95
8x0.75	2	0.4	1.0	8.5	134
10x0.75	2	0.4	1.1	10.0	169
12x0.75	2	0.4	1.1	10.3	192
14x0.75	2	0.4	1.1	10.8	216
16x0.75	2	0.4	1.1	11.4	240
20x0.75	2	0.4	1.2	12.4	295
24x0.75	2	0.4	1.3	14.3	358
27x0.75	2	0.4	1.3	14.6	391
30x0.75	2	0.4	1.3	15.1	425
37x0.75	2	0.4	1.3	16.2	506
40x0.75	2	0.4	1.4	16.9	552
1.0mm²					



Caledonian

FIRETOX LSZH Flame Retardant Instrumentation & Data Cables

www.caledonian-cables.co.uk www.addison-cables.com

Conductor		RE-2X(St)H			
No. of Core X Cross Section	Class of Conductor	Nominal Insulation Thickness	Nominal Sheath Thickness	Approx. Overall Diameter	Approx. Weight
mm ²		mm	mm	mm	kg/km
2x1.0	2	0.4	0.9	6.2	62
3x1.0	2	0.4	0.9	6.6	78
4x1.0	2	0.4	0.9	7.1	95
5x1.0	2	0.4	0.9	7.7	112
8x1.0	2	0.4	1.0	9.2	167
10x1.0	2	0.4	1.0	10.7	205
12x1.0	2	0.4	1.0	11.0	235
14x1.0	2	0.4	1.0	11.6	266
16x1.0	2	0.4	1.1	12.4	306
20x1.0	2	0.4	1.2	13.5	376
24x1.0	2	0.4	1.2	15.3	446
27x1.0	2	0.4	1.2	15.6	490
30x1.0	2	0.4	1.2	16.2	536
37x1.0	2	0.4	1.3	17.6	653
40x1.0	2	0.4	1.3	18.3	700
1.5mm ²					
2x1.5	2	0.5	0.9	7.2	80
3x1.5	2	0.5	0.9	7.6	103
4x1.5	2	0.5	1.0	8.5	133
5x1.5	2	0.5	1.0	9.2	158
8x1.5	2	0.5	1.1	10.9	236
10x1.5	2	0.5	1.1	12.8	290
12x1.5	2	0.5	1.1	13.2	333
14x1.5	2	0.5	1.2	14.0	387
16x1.5	2	0.5	1.2	14.8	433
20x1.5	2	0.5	1.3	16.1	534
24x1.5	2	0.5	1.3	18.3	633
27x1.5	2	0.5	1.4	18.9	709
30x1.5	2	0.5	1.4	19.6	776
37x1.5	2	0.5	1.4	21.1	931
40x1.5	2	0.5	1.5	22.1	1012

500V

Conductor		RE-2X(St)H			
No. of Core X Cross Section	Class of Conductor	Nominal Insulation Thickness	Nominal Sheath Thickness	Approx. Overall Diameter	Approx. Weight
mm ²		mm	mm	mm	kg/km
0.5mm ²					
2x0.5	2	0.6	0.9	6.3	52
3x0.5	2	0.6	0.9	6.6	63
4x0.5	2	0.6	0.9	7.1	75
5x0.5	2	0.6	0.9	7.8	88
8x0.5	2	0.6	1.0	9.2	128

Conductor		RE-2X(St)H			
No. of Core X Cross Section	Class of Conductor	Nominal Insulation Thickness	Nominal Sheath Thickness	Approx. Overall Diameter	Approx. Weight
mm ²		mm	mm	mm	kg/km
10x0.5	2	0.6	1.0	10.7	156
12x0.5	2	0.6	1.1	11.2	183
14x0.5	2	0.6	1.1	11.8	205
16x0.5	2	0.6	1.1	12.4	228
20x0.5	2	0.6	1.2	13.6	279
24x0.5	2	0.6	1.2	15.4	329
27x0.5	2	0.6	1.2	15.7	358
30x0.5	2	0.6	1.3	16.5	399
37x0.5	2	0.6	1.3	17.7	472
40x0.5	2	0.6	1.3	18.3	505
0.75mm ²					
2x0.75	2	0.6	0.9	6.6	60
3x0.75	2	0.6	0.9	7.0	74
4x0.75	2	0.6	0.9	7.6	89
5x0.75	2	0.6	1.0	8.4	110
8x0.75	2	0.6	1.0	9.8	155
10x0.75	2	0.6	1.0	11.4	189
12x0.75	2	0.6	1.0	11.8	215
14x0.75	2	0.6	1.1	12.6	250
16x0.75	2	0.6	1.1	13.3	278
20x0.75	2	0.6	1.2	14.5	342
24x0.75	2	0.6	1.3	16.7	414
27x0.75	2	0.6	1.3	17.0	452
30x0.75	2	0.6	1.3	17.6	493
37x0.75	2	0.6	1.4	19.2	598
40x0.75	2	0.6	1.4	19.9	639
1.0mm ²					
2x1.0	2	0.6	0.9	7.0	70
3x1.0	2	0.6	0.9	7.4	88
4x1.0	2	0.6	1.0	8.3	113
5x1.0	2	0.6	1.0	9.0	133
8x1.0	2	0.6	1.0	10.5	190
10x1.0	2	0.6	1.1	12.5	240
12x1.0	2	0.6	1.1	12.9	274
14x1.0	2	0.6	1.1	13.5	310
16x1.0	2	0.6	1.2	14.4	355
20x1.0	2	0.6	1.2	15.6	426
24x1.0	2	0.6	1.3	17.9	516
27x1.0	2	0.6	1.3	18.3	565
30x1.0	2	0.6	1.3	19.0	617
37x1.0	2	0.6	1.4	20.6	751
40x1.0	2	0.6	1.4	21.4	804
1.5mm ²					
2x1.5	2	0.6	0.9	7.6	85



Caledonian

FIRETOX LSZH Flame Retardant Instrumentation & Data Cables

www.caledonian-cables.co.uk www.addison-cables.com

Conductor		RE-2X(St)H			
No. of Core X Cross Section	Class of Conductor	Nominal Insulation Thickness	Nominal Sheath Thickness	Approx. Overall Diameter	Approx. Weight
mm ²		mm	mm	mm	kg/km
3x1.5	2	0.6	1.0	8.2	114
4x1.5	2	0.6	1.0	8.9	140
5x1.5	2	0.6	1.0	9.7	166
8x1.5	2	0.6	1.1	11.6	248
10x1.5	2	0.6	1.2	13.8	314
12x1.5	2	0.6	1.2	14.2	359
14x1.5	2	0.6	1.2	14.9	407
16x1.5	2	0.6	1.2	15.7	456
20x1.5	2	0.6	1.3	17.2	562
24x1.5	2	0.6	1.4	19.7	679
27x1.5	2	0.6	1.4	20.2	746
30x1.5	2	0.6	1.4	20.9	816
37x1.5	2	0.6	1.5	22.7	993
40x1.5	2	0.6	1.5	23.6	1065
2.5mm ²					
2x2.5	2	0.7	1.0	9.0	122
3x2.5	2	0.7	1.0	9.5	159
4x2.5	2	0.7	1.0	10.4	198
5x2.5	2	0.7	1.1	11.6	245
8x2.5	2	0.7	1.2	13.9	367
10x2.5	2	0.7	1.3	16.4	463
12x2.5	2	0.7	1.3	17.0	534
14x2.5	2	0.7	1.3	17.9	607
16x2.5	2	0.7	1.4	19.0	694
20x2.5	2	0.7	1.4	20.6	840
24x2.5	2	0.7	1.5	23.7	1014
27x2.5	2	0.7	1.6	24.4	1133
30x2.5	2	0.7	1.6	25.3	1242
37x2.5	2	0.7	1.7	27.5	1511
40x2.5	2	0.7	1.7	28.5	1622

Note: Other conductor sizes & core configurations are available upon request.



Rated Voltage



Standard



Flame Retardancy
BS EN 60332-1-2



Reduced Fire Propagation
EN 60332-3-24

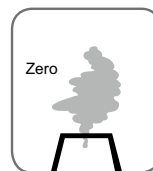

Halogen Free
IEC 60754-1



Low Corrosivity
IEC 60754-2



Low Smoke Emission
IEC 61034-2

LSZH Flame Retardant Overall Screened, Armoured Instrumentation Cables (Multicore)

RE-2X(St)HSAH

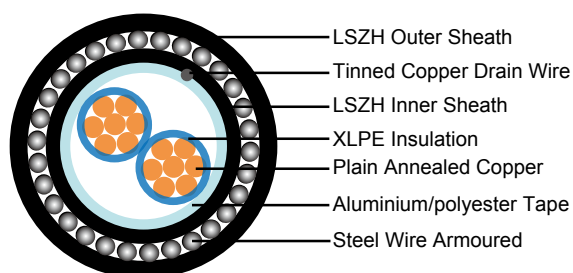

APPLICATION

The LSZH sheathed cables are generally used for indoor installation and suitable for wet and damp areas. The galvanized steel wire armour provides excellent protection. Generally, the cables are used within industrial process manufacturing plants for communication, data and voice transmission signals and services. Also used for the interconnection of electrical equipment and instruments, the LSZH sheath can reduce toxic smoke and fume emission. This product type is TUV approved.

STANDARDS

Basic design to BS EN 50288-7 (formerly BS 5308)



Approvals:

TUV Certification (Z1 17 12 98200 014)

FIRE PERFORMANCE

Flame Retardance (Single vertical wire or cable test)	IEC 60332-1-2; EN 60332-1-2
Reduced Fire Propagation (Vertically-mounted bundled wires & cables test)	IEC 60332-3-24; EN 60332-3-24
Halogen Free	IEC 60754-1; EN 50267-2-1
No Corrosive Gas Emission	IEC 60754-2; EN 50267-2-2
Minimum Smoke Emission	IEC 61034-2; EN 61034-2

VOLTAGE RATING

300, 500V

CABLE CONSTRUCTION

Conductor: Plain or metal coated copper wire, solid, stranded or flexible according to IEC 60228 class 1, 2 and 5.



Caledonian

FIRETOX LSZH Flame Retardant Instrumentation & Data Cables

www.caledonian-cables.co.uk www.addison-cables.com

Insulation: Extruded XLPE compound according to EN 50290-2-29. LSZH, PE, PP compound can be offered as options.

Overall Screen: Aluminium/polyester tape is applied over the laid up cores with metallic side down in contact with tinned copper drain wire, 0.5mm². Copper braid screen or aluminium/polyester tape combined with copper braid screen can be offered as option.

Inner Sheath: Thermoplastic LSZH compound.

Armouring: Galvanised steel wire.

Outer Sheath: Thermoplastic LSZH compound type LTS3 as per BS 7655-6.1 (Thermosetting LSZH compound type SW2-SW4 as per BS 7655-2.6 can be offered).

Outer Sheath Option: UV resistance, hydrocarbon resistance, oil resistance, anti-rodent and anti-termite properties can be offered as option.

COLOUR CODE

Insulation Colour: Colours and/or additional ring markings and/or symbols achieved by the use of coloured insulation or by a coloured surface using extrusion, printing or painting.

Outer Sheath: Black. Other colours can be offered upon request.

PHYSICAL AND THERMAL PROPERTIES

Temperature range during operation: -30°C - +90°C

Temperature range fixed installation: -5°C - +50°C

Maximum short circuit temperature (5 Seconds): 250°C

Minimum bending radius: 10 x Overall Diameter

ELECTRICAL PROPERTIES

300V

Conductor Area Size	mm ²	0.5	0.75	1.0	1.5
Insulation Thickness (Nominal)	mm	0.4	0.4	0.4	0.5
Insulation Thickness (Minimum)	mm	0.26	0.26	0.26	0.35
Conductor Resistance (20°C)	ohm/km	36.7	25.0	18.5	12.3
Minimum Insulation Resistance (20°C)	Mohm/km	1000			
Maximum Mutual Capacitance	nf/km	250			
Capacitance Unbalance	pf/500m	500			
Maximum L/R (ratio)	µH/Ω	25	25	25	40
Operating Voltage	V	300			
Dielectric Strength for 1 Minute	AC	V	≥1000		
	DC	V	≥2000		

500V

Conductor Area Size	mm ²	0.5	0.75	1.0	1.5	2.5
Insulation Thickness (Nominal)	mm	0.6	0.6	0.6	0.6	0.7

Insulation Thickness (Minimum)		mm	0.44	0.44	0.44	0.44	0.53
Conductor Resistance (20°C)		ohm/km	36.7	25.0	18.5	12.3	7.4
Minimum Insulation Resistance (20°C)		Mohm/km	1000				
Maximum Mutual Capacitance		nf/km	250				
Capacitance Unbalance		pf/500m	500				
Maximum L/R (ratio)		μH/Ω	25	25	25	40	60
Operating Voltage		V	500				
Dielectric Strength for 1 Minute	AC	V	≥2000				
	DC	V	≥3000				

CONSTRUCTION PARAMETERS

300V

Conductor		RE-2X(St)HSWAH					
No. of Core X Cross Section	Class of Conductor	Nominal Insulation Thickness	Nominal Inner Sheath Thickness	Nominal Armour Wire Diameter	Nominal Outer Sheath Thickness	Approx. Overall Diameter	Approx. Weight
mm ²		mm	mm	mm	mm	mm	kg/km
0.5mm ²							
2x0.5	2	0.4	0.9	0.9	1.3	9.9	215
3x0.5	2	0.4	0.9	0.9	1.3	10.1	232
4x0.5	2	0.4	0.9	0.9	1.3	10.6	254
5x0.5	2	0.4	0.9	0.9	1.3	11.1	278
8x0.5	2	0.4	1.0	0.9	1.4	12.5	351
10x0.5	2	0.4	1.0	0.9	1.4	13.7	407
12x0.5	2	0.4	1.0	0.9	1.4	14.0	431
14x0.5	2	0.4	1.0	0.9	1.4	14.4	461
16x0.5	2	0.4	1.0	0.9	1.4	15.0	493
20x0.5	2	0.4	1.1	0.9	1.5	16.1	571
24x0.5	2	0.4	1.1	0.9	1.5	17.6	652
27x0.5	2	0.4	1.1	0.9	1.5	17.8	684
30x0.5	2	0.4	1.2	0.9	1.5	18.5	736
37x0.5	2	0.4	1.2	0.9	1.6	19.7	836
40x0.5	2	0.4	1.2	1.25	1.6	20.9	1002
0.75mm ²							
2x0.75	2	0.4	0.9	0.9	1.3	10.2	233
3x0.75	2	0.4	0.9	0.9	1.3	10.5	252
4x0.75	2	0.4	0.9	0.9	1.4	11.2	284
5x0.75	2	0.4	1.0	0.9	1.4	12.0	323
8x0.75	2	0.4	1.0	0.9	1.4	13.1	392
10x0.75	2	0.4	1.1	0.9	1.5	14.8	477
12x0.75	2	0.4	1.1	0.9	1.5	15.1	508
14x0.75	2	0.4	1.1	0.9	1.5	15.6	545
16x0.75	2	0.4	1.1	0.9	1.5	16.2	585
20x0.75	2	0.4	1.2	0.9	1.6	17.4	679
24x0.75	2	0.4	1.3	0.9	1.6	19.3	793
27x0.75	2	0.4	1.3	0.9	1.6	19.6	834



Caledonian

FIRETOX LSZH Flame Retardant Instrumentation & Data Cables

www.caledonian-cables.co.uk www.addison-cables.com

Conductor		RE-2X(St)HSAWAH					
No. of Core X Cross Section	Class of Conductor	Nominal Insulation Thickness	Nominal Inner Sheath Thickness	Nominal Armour Wire Diameter	Nominal Outer Sheath Thickness	Approx. Overall Diameter	Approx. Weight
mm ²		mm	mm	mm	mm	mm	kg/km
30x0.75	2	0.4	1.3	1.25	1.6	20.8	1006
37x0.75	2	0.4	1.3	1.25	1.7	22.1	1138
40x0.75	2	0.4	1.4	1.25	1.7	22.8	1212
1.0mm ²							
2x1.0	2	0.4	0.9	0.9	1.3	10.6	253
3x1.0	2	0.4	0.9	0.9	1.3	11.0	278
4x1.0	2	0.4	0.9	0.9	1.4	11.7	316
5x1.0	2	0.4	0.9	0.9	1.4	12.3	350
8x1.0	2	0.4	1.0	0.9	1.4	13.8	444
10x1.0	2	0.4	1.0	0.9	1.5	15.5	531
12x1.0	2	0.4	1.0	0.9	1.5	15.8	569
14x1.0	2	0.4	1.0	0.9	1.5	16.4	616
16x1.0	2	0.4	1.1	0.9	1.5	17.2	678
20x1.0	2	0.4	1.2	0.9	1.5	18.3	780
24x1.0	2	0.4	1.2	1.25	1.6	21.0	1035
27x1.0	2	0.4	1.2	1.25	1.6	21.3	1091
30x1.0	2	0.4	1.2	1.25	1.6	21.9	1157
37x1.0	2	0.4	1.3	1.25	1.7	23.5	1338
40x1.0	2	0.4	1.3	1.25	1.7	24.2	1408
1.5mm ²							
2x1.5	2	0.5	0.9	0.9	1.4	11.8	303
3x1.5	2	0.5	0.9	0.9	1.4	12.2	336
4x1.5	2	0.5	1.0	0.9	1.4	13.1	390
5x1.5	2	0.5	1.0	0.9	1.4	13.8	435
8x1.5	2	0.5	1.1	0.9	1.5	15.7	569
10x1.5	2	0.5	1.1	0.9	1.5	17.6	673
12x1.5	2	0.5	1.1	0.9	1.5	18.0	727
14x1.5	2	0.5	1.2	0.9	1.5	18.8	805
16x1.5	2	0.5	1.2	0.9	1.6	19.8	883
20x1.5	2	0.5	1.3	1.25	1.6	21.8	1153
24x1.5	2	0.5	1.3	1.25	1.7	24.2	1343
27x1.5	2	0.5	1.4	1.25	1.7	24.8	1440
30x1.5	2	0.5	1.4	1.25	1.7	25.5	1532
37x1.5	2	0.5	1.4	1.25	1.8	27.2	1757
40x1.5	2	0.5	1.5	1.25	1.8	28.2	1874

500V

Conductor		RE-2X(St)HSAWAH					
No. of Core X Cross Section	Class of Conductor	Nominal Insulation Thickness	Nominal Inner Sheath Thickness	Nominal Armour Wire Diameter	Nominal Outer Sheath Thickness	Approx. Overall Diameter	Approx. Weight
mm ²		mm	mm	mm	mm	mm	kg/km
0.5mm ²							
2x0.5	2	0.6	0.9	0.9	1.3	10.7	244

Conductor		RE-2X(St)HSAWAH					
No. of Core X Cross Section	Class of Conductor	Nominal Insulation Thickness	Nominal Inner Sheath Thickness	Nominal Armour Wire Diameter	Nominal Outer Sheath Thickness	Approx. Overall Diameter	Approx. Weight
mm ²		mm	mm	mm	mm	mm	kg/km
3x0.5	2	0.6	0.9	0.9	1.3	11.0	264
4x0.5	2	0.6	0.9	0.9	1.4	11.7	297
5x0.5	2	0.6	0.9	0.9	1.4	12.4	326
8x0.5	2	0.6	1.0	0.9	1.4	13.8	406
10x0.5	2	0.6	1.0	0.9	1.5	15.5	483
12x0.5	2	0.6	1.1	0.9	1.5	16.0	524
14x0.5	2	0.6	1.1	0.9	1.5	16.6	562
16x0.5	2	0.6	1.1	0.9	1.5	17.2	601
20x0.5	2	0.6	1.2	0.9	1.5	18.4	684
24x0.5	2	0.6	1.2	1.25	1.6	21.1	920
27x0.5	2	0.6	1.2	1.25	1.6	21.4	962
30x0.5	2	0.6	1.3	1.25	1.6	22.2	1029
37x0.5	2	0.6	1.3	1.25	1.6	23.4	1147
40x0.5	2	0.6	1.3	1.25	1.7	24.2	1215
0.75mm ²							
2x0.75	2	0.6	0.9	0.9	1.3	11.0	262
3x0.75	2	0.6	0.9	0.9	1.3	11.4	285
4x0.75	2	0.6	0.9	0.9	1.4	12.2	322
5x0.75	2	0.6	1.0	0.9	1.4	13.0	367
8x0.75	2	0.6	1.0	0.9	1.4	14.4	449
10x0.75	2	0.6	1.0	0.9	1.5	16.2	535
12x0.75	2	0.6	1.0	0.9	1.5	16.6	571
14x0.75	2	0.6	1.1	0.9	1.5	17.4	628
16x0.75	2	0.6	1.1	0.9	1.5	18.1	675
20x0.75	2	0.6	1.2	0.9	1.6	19.5	784
24x0.75	2	0.6	1.3	1.25	1.6	22.4	1051
27x0.75	2	0.6	1.3	1.25	1.6	22.7	1102
30x0.75	2	0.6	1.3	1.25	1.6	23.3	1163
37x0.75	2	0.6	1.4	1.25	1.7	25.1	1338
40x0.75	2	0.6	1.4	1.25	1.7	25.8	1404
1.0mm ²							
2x1.0	2	0.6	0.9	0.9	1.3	11.4	283
3x1.0	2	0.6	0.9	0.9	1.4	12.0	317
4x1.0	2	0.6	1.0	0.9	1.4	12.9	365
5x1.0	2	0.6	1.0	0.9	1.4	13.6	405
8x1.0	2	0.6	1.0	0.9	1.4	15.1	502
10x1.0	2	0.6	1.1	0.9	1.5	17.3	615
12x1.0	2	0.6	1.1	0.9	1.5	17.7	660
14x1.0	2	0.6	1.1	0.9	1.5	18.3	714
16x1.0	2	0.6	1.2	0.9	1.6	19.4	795
20x1.0	2	0.6	1.2	1.25	1.6	21.3	1025
24x1.0	2	0.6	1.3	1.25	1.6	23.6	1197
27x1.0	2	0.6	1.3	1.25	1.7	24.2	1274
30x1.0	2	0.6	1.3	1.25	1.7	24.9	1350
37x1.0	2	0.6	1.4	1.25	1.7	26.5	1544



Caledonian

FIRETOX LSZH Flame Retardant Instrumentation & Data Cables

www.caledonian-cables.co.uk www.addison-cables.com

Conductor		RE-2X(St)HSAWAH					
No. of Core X Cross Section	Class of Conductor	Nominal Insulation Thickness	Nominal Inner Sheath Thickness	Nominal Armour Wire Diameter	Nominal Outer Sheath Thickness	Approx. Overall Diameter	Approx. Weight
mm ²		mm	mm	mm	mm	mm	kg/km
40x1.0	2	0.6	1.4	1.25	1.8	27.5	1640
1.5mm ²							
2x1.5	2	0.6	0.9	0.9	1.3	12.2	318
3x1.5	2	0.6	1.0	0.9	1.4	12.8	364
4x1.5	2	0.6	1.0	0.9	1.4	13.5	410
5x1.5	2	0.6	1.0	0.9	1.4	14.3	458
8x1.5	2	0.6	1.1	0.9	1.5	16.4	599
10x1.5	2	0.6	1.2	0.9	1.5	18.6	724
12x1.5	2	0.6	1.2	0.9	1.6	19.2	792
14x1.5	2	0.6	1.2	0.9	1.6	19.9	861
16x1.5	2	0.6	1.2	1.25	1.6	21.4	1060
20x1.5	2	0.6	1.3	1.25	1.7	23.1	1230
24x1.5	2	0.6	1.4	1.25	1.7	25.6	1439
27x1.5	2	0.6	1.4	1.25	1.7	26.1	1522
30x1.5	2	0.6	1.4	1.25	1.8	27.0	1633
37x1.5	2	0.6	1.5	1.25	1.8	28.8	1878
40x1.5	2	0.6	1.5	1.25	1.8	29.7	1980
2.5mm ²							
2x2.5	2	0.7	1.0	0.9	1.4	13.6	394
3x2.5	2	0.7	1.0	0.9	1.4	14.1	445
4x2.5	2	0.7	1.0	0.9	1.4	15.0	508
5x2.5	2	0.7	1.1	0.9	1.5	16.4	596
8x2.5	2	0.7	1.2	0.9	1.5	18.7	781
10x2.5	2	0.7	1.3	1.25	1.6	22.1	1092
12x2.5	2	0.7	1.3	1.25	1.6	22.7	1182
14x2.5	2	0.7	1.3	1.25	1.7	23.8	1300
16x2.5	2	0.7	1.4	1.25	1.7	25.0	1428
20x2.5	2	0.7	1.4	1.25	1.8	26.7	1646
24x2.5	2	0.7	1.5	1.25	1.8	29.8	1932
27x2.5	2	0.7	1.6	1.25	1.9	30.7	2095
30x2.5	2	0.7	1.6	1.6	1.9	32.3	2438
37x2.5	2	0.7	1.7	1.6	1.9	34.5	2805
40x2.5	2	0.7	1.7	1.6	2.0	35.7	2981

Note: Other conductor sizes & core configurations are available upon request.



Rated Voltage



Standard



Flame Retardancy
BS EN 60332-1-2



Reduced Fire Propagation
EN 60332-3-24

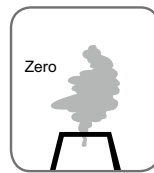

Halogen Free
IEC 60754-1



Low Corrosivity
IEC 60754-2



Low Smoke Emission
IEC 61034-2

LSZH Flame Retardant Overall Screened Instrumentation Cables (Multipair)

RE-2X(St)H

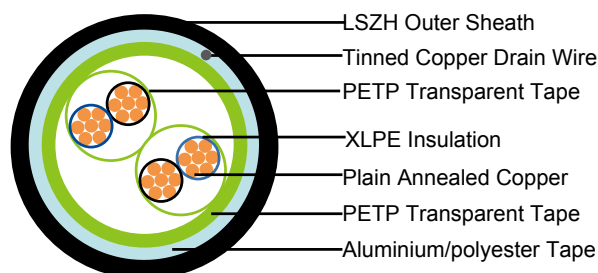

APPLICATION

The unarmoured LSZH sheathed cables are generally used for indoor installation and suitable for wet and damp areas. Generally, the cables are used within industrial process manufacturing plants for communication, data and voice transmission signals and services. Also used for the interconnection of electrical equipment and instruments, the LSZH sheath can reduce toxic smoke and fume emission. This product type is TUV approved.

STANDARDS

Basic design to BS EN 50288-7 (formerly BS 5308)



Approvals:

TUV Certification (Z1 17 12 98200 014)

FIRE PERFORMANCE

Flame Retardance (Single vertical wire or cable test)	IEC 60332-1-2; EN 60332-1-2
Reduced Fire Propagation (Vertically-mounted bundled wires & cables test)	IEC 60332-3-24; EN 60332-3-24
Halogen Free	IEC 60754-1; EN 50267-2-1
No Corrosive Gas Emission	IEC 60754-2; EN 50267-2-2
Minimum Smoke Emission	IEC 61034-2; EN 61034-2

VOLTAGE RATING

300V, 500V

CABLE CONSTRUCTION

Conductor: Plain or metal coated copper wire, solid, stranded or flexible according to IEC 60228 class 1, 2 and 5.

Insulation: Extruded XLPE compound according to EN 50290-2-29. LSZH, PE, PP compound can be offered as options.

Pairs: Two insulated conductors uniformly twisted together with a lay not exceeding 100mm ($\leq 1.5\text{mm}^2$) or



Caledonian

FIRETOX LSZH Flame Retardant Instrumentation & Data Cables

www.caledonian-cables.co.uk www.addison-cables.com

150mm (for 2.5mm²).

Binder tape: PETP transparent tape.

Overall Screen: Aluminium/polyester tape is applied over the laid up pairs with metallic side down in contact with tinned copper drain wire, 0.5mm². Copper braid screen or aluminium/polyester tape combined with copper braid screen can be offered as option.

Outer Sheath: Thermoplastic LSZH compound type LTS3 as per BS 7655-6.1 (Thermosetting LSZH compound type SW2-SW4 as per BS 7655-2.6 can be offered).

Outer Sheath Option: UV resistance, hydrocarbon resistance, oil resistance, anti-rodent and anti-termite properties can be offered as option.

COLOUR CODE

Insulation Colour: Colours and/or additional ring markings and/or symbols achieved by the use of coloured insulation or by a coloured surface using extrusion, printing or painting.

Outer Sheath: Black. Other colours can be offered upon request.

PHYSICAL AND THERMAL PROPERTIES

Temperature range during operation: -30°C - +90°C

Temperature range fixed installation: -5°C - +50°C

Maximum short circuit temperature (5 Seconds): 250°C

Minimum bending radius: 7.5 x Overall Diameter

ELECTRICAL PROPERTIES

300V

Conductor Area Size	mm ²	0.5	0.75	1.0	1.5
Insulation Thickness (Nominal)	mm	0.4	0.4	0.4	0.5
Insulation Thickness (Minimum)	mm	0.26	0.26	0.26	0.35
Conductor Resistance (20°C)	ohm/km	36.7	25.0	18.5	12.3
Minimum Insulation Resistance (20°C)	Mohm/km	1000			
Maximum Mutual Capacitance	nf/km	250			
Capacitance Unbalance	pf/500m	500			
Maximum L/R (ratio)	μH/Ω	25	25	25	40
Operating Voltage	V	300			
Dielectric Strength for 1 Minute	AC	V	≥1000		
	DC	V	≥2000		

500V

Conductor Area Size	mm ²	0.5	0.75	1.0	1.5	2.5
Insulation Thickness (Nominal)	mm	0.6	0.6	0.6	0.6	0.7
Insulation Thickness (Minimum)	mm	0.44	0.44	0.44	0.44	0.53
Conductor Resistance (20°C)	ohm/km	36.7	25.0	18.5	12.3	7.4
Minimum Insulation Resistance (20°C)	Mohm/km	1000				
Maximum Mutual Capacitance	nf/km	250				

Capacitance Unbalance		pf/500m	500				
Maximum L/R (ratio)		$\mu\text{H}/\Omega$	25	25	25	40	60
Operating Voltage		V	500				
Dielectric Strength for 1 Minute	AC	V	≥ 2000				
	DC	V	≥ 3000				

CONSTRUCTION PARAMETERS

300V

Conductor		RE-2X(St)H			
No. of Pairs X Cross Section	Class of Conductor	Nominal Insulation Thickness	Nominal Outer Sheath Thickness	Approx. Overall Diameter	Approx. Weight
mm^2		mm	mm	mm	kg/km
0.5mm²					
1x2x0.5	2	0.4	0.9	5.5	44
2x2x0.5	2	0.4	0.9	7.7	74
3x2x0.5	2	0.4	1.0	8.3	97
4x2x0.5	2	0.4	1.0	9.0	117
5x2x0.5	2	0.4	1.1	10.1	144
8x2x0.5	2	0.4	1.1	11.8	203
10x2x0.5	2	0.4	1.1	13.7	249
12x2x0.5	2	0.4	1.2	14.4	291
16x2x0.5	2	0.4	1.2	15.9	365
20x2x0.5	2	0.4	1.3	17.4	448
24x2x0.5	2	0.4	1.3	19.8	530
0.75mm²					
1x2x0.75	2	0.4	0.9	5.8	52
2x2x0.75	2	0.4	1.0	8.5	94
3x2x0.75	2	0.4	1.0	8.9	118
4x2x0.75	2	0.4	1.1	10.0	150
5x2x0.75	2	0.4	1.1	10.9	177
8x2x0.75	2	0.4	1.1	12.7	254
10x2x0.75	2	0.4	1.2	15.1	321
12x2x0.75	2	0.4	1.2	15.6	366
16x2x0.75	2	0.4	1.3	17.5	474
20x2x0.75	2	0.4	1.4	19.1	581
24x2x0.75	2	0.4	1.4	21.8	689
1.0mm²					
1x2x1.0	2	0.4	0.9	6.2	62
2x2x1.0	2	0.4	1.0	9.2	113
3x2x1.0	2	0.4	1.1	9.9	151
4x2x1.0	2	0.4	1.1	10.8	186
5x2x1.0	2	0.4	1.1	11.8	221
8x2x1.0	2	0.4	1.2	14.1	330
10x2x1.0	2	0.4	1.2	16.5	406
12x2x1.0	2	0.4	1.3	17.2	477
16x2x1.0	2	0.4	1.4	19.3	618
20x2x1.0	2	0.4	1.4	20.9	745



Caledonian

FIRETOX LSZH Flame Retardant Instrumentation & Data Cables

www.caledonian-cables.co.uk www.addison-cables.com

Conductor		RE-2X(St)H			
No. of Pairs X Cross Section	Class of Conductor	Nominal Insulation Thickness	Nominal Outer Sheath Thickness	Approx. Overall Diameter	Approx. Weight
mm ²		mm	mm	mm	kg/km
24x2x1.0	2	0.4	1.5	24.1	900
1.5mm ²					
1x2x1.5	2	0.5	0.9	7.2	80
2x2x1.5	2	0.5	1.1	10.9	156
3x2x1.5	2	0.5	1.1	11.5	202
4x2x1.5	2	0.5	1.2	12.9	260
5x2x1.5	2	0.5	1.2	14.1	311
8x2x1.5	2	0.5	1.3	16.8	465
10x2x1.5	2	0.5	1.4	20.0	586
12x2x1.5	2	0.5	1.4	20.6	674
16x2x1.5	2	0.5	1.5	23.2	874
20x2x1.5	2	0.5	1.6	25.3	1074
24x2x1.5	2	0.5	1.7	29.1	1294

500V

Conductor		RE-2X(St)H			
No. of Pairs X Cross Section	Class of Conductor	Nominal Insulation Thickness	Nominal Outer Sheath Thickness	Approx. Overall Diameter	Approx. Weight
mm ²		mm	mm	mm	kg/km
0.5mm ²					
1x2x0.5	2	0.6	0.9	6.3	52
2x2x0.5	2	0.6	1.0	9.2	93
3x2x0.5	2	0.6	1.0	9.7	115
4x2x0.5	2	0.6	1.1	10.8	146
5x2x0.5	2	0.6	1.1	11.8	172
8x2x0.5	2	0.6	1.2	14.1	250
10x2x0.5	2	0.6	1.2	16.6	306
12x2x0.5	2	0.6	1.3	17.3	358
16x2x0.5	2	0.6	1.4	19.4	459
20x2x0.5	2	0.6	1.4	21.0	546
24x2x0.5	2	0.6	1.5	24.2	661
0.75mm ²					
1x2x0.75	2	0.6	0.9	6.6	60
2x2x0.75	2	0.6	1.0	9.8	109
3x2x0.75	2	0.6	1.1	10.6	143
4x2x0.75	2	0.6	1.1	11.5	174
5x2x0.75	2	0.6	1.2	12.8	214
8x2x0.75	2	0.6	1.2	15.1	304
10x2x0.75	2	0.6	1.3	18.0	384
12x2x0.75	2	0.6	1.3	18.5	436
16x2x0.75	2	0.6	1.4	20.8	562
20x2x0.75	2	0.6	1.5	22.7	687
24x2x0.75	2	0.6	1.6	26.1	830
1.0mm ²					
1x2x1.0	2	0.6	0.9	7.0	70

Conductor		RE-2X(St)H			
No. of Pairs X Cross Section	Class of Conductor	Nominal Insulation Thickness	Nominal Outer Sheath Thickness	Approx. Overall Diameter	Approx. Weight
mm ²		mm	mm	mm	kg/km
2x2x1.0	2	0.6	1.0	10.5	129
3x2x1.0	2	0.6	1.1	11.3	171
4x2x1.0	2	0.6	1.2	12.6	219
5x2x1.0	2	0.6	1.2	13.8	260
8x2x1.0	2	0.6	1.2	16.2	374
10x2x1.0	2	0.6	1.3	19.3	472
12x2x1.0	2	0.6	1.4	20.2	553
16x2x1.0	2	0.6	1.5	22.6	714
20x2x1.0	2	0.6	1.5	24.5	859
24x2x1.0	2	0.6	1.6	28.2	1037
1.5mm ²					
1x2x1.5	2	0.6	0.9	7.6	85
2x2x1.5	2	0.6	1.1	11.6	165
3x2x1.5	2	0.6	1.2	12.5	221
4x2x1.5	2	0.6	1.2	13.6	274
5x2x1.5	2	0.6	1.3	15.2	337
8x2x1.5	2	0.6	1.3	17.9	490
10x2x1.5	2	0.6	1.4	21.3	617
12x2x1.5	2	0.6	1.5	22.2	724
16x2x1.5	2	0.6	1.6	24.9	936
20x2x1.5	2	0.6	1.7	27.2	1147
24x2x1.5	2	0.6	1.8	31.3	1382
2.5mm ²					
1x2x2.5	2	0.7	1.0	9.4	122
2x2x2.5	2	0.7	1.2	13.8	237
3x2x2.5	2	0.7	1.2	14.6	312
4x2x2.5	2	0.7	1.3	16.3	401
5x2x2.5	2	0.7	1.4	18.1	493
8x2x2.5	2	0.7	1.4	21.5	727
10x2x2.5	2	0.7	1.6	25.8	930
12x2x2.5	2	0.7	1.6	26.6	1074
16x2x2.5	2	0.7	1.7	29.9	1394
20x2x2.5	2	0.7	1.9	32.8	1732
24x2x2.5	2	0.7	2.0	37.8	2084



Rated Voltage

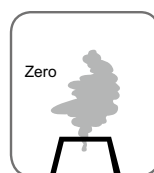
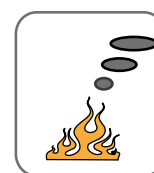

Standard

Flame Retardancy
BS EN 60332-1-2Reduced Fire Propagation
EN 60332-3-24Halogen Free
IEC 60754-1Low Corrosivity
IEC 60754-2Low Smoke Emission
IEC 61034-2



Caledonian

FIRETOX LSZH Flame Retardant Instrumentation & Data Cables

www.caledonian-cables.co.uk www.addison-cables.com

LSZH Flame Retardant Individual and Overall Screened Instrumentation Cables (Multipair)

RE-2X(St)H PiMF

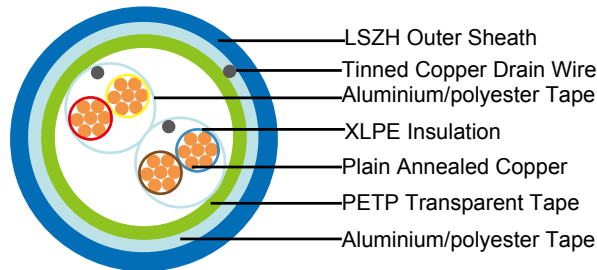

APPLICATION

The unarmoured LSZH sheathed cables are generally used for indoor installation and suitable for wet and damp areas. Generally, the cables are used within industrial process manufacturing plants for communication, data and voice transmission signals and services. Also used for the interconnection of electrical equipment and instruments, the LSZH sheath can reduce toxic smoke and fume emission. This product type is TUV approved.

STANDARDS

Basic design to BS EN 50288-7 (formerly BS 5308)



Approvals:

TUV Certification (Z1 17 12 98200 014)

FIRE PERFORMANCE

Flame Retardance (Single vertical wire or cable test)	IEC 60332-1-2; EN 60332-1-2
Reduced Fire Propagation (Vertically-mounted bundled wires & cables test)	IEC 60332-3-24; EN 60332-3-24
Halogen Free	IEC 60754-1; EN 50267-2-1
No Corrosive Gas Emission	IEC 60754-2; EN 50267-2-2
Minimum Smoke Emission	IEC 61034-2; EN 61034-2

VOLTAGE RATING

300V, 500V

CABLE CONSTRUCTION

Conductor: Plain or metal coated copper wire, solid, stranded or flexible according to IEC 60228 class 1, 2 and 5.

Insulation: Extruded XLPE compound according to EN 50290-2-29. LSZH, PE, PP compound can be offered as options.

Pairs: Two insulated conductors uniformly twisted together with a lay not exceeding 100mm ($\leq 1.5\text{mm}^2$) or

150mm (for 2.5mm²).

Individual Screen: Aluminium/polyester tape is applied over each pair with metallic side down in contact with tinned copper drain wire, 0.5mm².

Binder tape: PETP transparent tape.

Overall Screen: Aluminium/polyester tape is applied over the laid up pairs with metallic side down in contact with tinned copper drain wire, 0.5mm². Copper braid screen or aluminium/polyester tape combined with copper braid screen can be offered as option.

Outer Sheath: Thermoplastic LSZH compound type LTS3 as per BS 7655-6.1 (Thermosetting LSZH compound type SW2-SW4 as per BS 7655-2.6 can be offered).

Outer Sheath Option: UV resistance, hydrocarbon resistance, oil resistance, anti-rodent and anti-termite properties can be offered as option.

COLOUR CODE

Insulation Colour: Colours and/or additional ring markings and/or symbols achieved by the use of coloured insulation or by a coloured surface using extrusion, printing or painting.

Outer Sheath: Black. Other colours can be offered upon request.

PHYSICAL AND THERMAL PROPERTIES

Temperature range during operation: -30°C - +90°C

Temperature range fixed installation: -5°C - +50°C

Maximum short circuit temperature (5 Seconds): 250°C

Minimum bending radius: 7.5 x Overall Diameter

ELECTRICAL PROPERTIES

300V

Conductor Area Size	mm ²	0.5	0.75	1.0	1.5
Insulation Thickness (Nominal)	mm	0.4	0.4	0.4	0.5
Insulation Thickness (Minimum)	mm	0.26	0.26	0.26	0.35
Conductor Resistance (20°C)	ohm/km	36.7	25.0	18.5	12.3
Minimum Insulation Resistance (20°C)	Mohm/km	1000			
Maximum Mutual Capacitance	nf/km	250			
Capacitance Unbalance	pf/500m	500			
Maximum L/R (ratio)	μH/Ω	25	25	25	40
Operating Voltage	V	300			
Dielectric Strength for 1 Minute	AC	V	≥1000		
	DC	V	≥2000		

500V

Conductor Area Size	mm ²	0.5	0.75	1.0	1.5	2.5
Insulation Thickness (Nominal)	mm	0.6	0.6	0.6	0.6	0.7
Insulation Thickness (Minimum)	mm	0.44	0.44	0.44	0.44	0.53



Caledonian

FIRETOX LSZH Flame Retardant Instrumentation & Data Cables

www.caledonian-cables.co.uk www.addison-cables.com

Conductor Resistance (20°C)	ohm/km	36.7	25.0	18.5	12.3	7.4
Minimum Insulation Resistance (20°C)	Mohm/km	1000				
Maximum Mutual Capacitance	nf/km	250				
Capacitance Unbalance	pf/500m	500				
Maximum L/R (ratio)	μH/Ω	25	25	25	40	60
Operating Voltage	V	500				
Dielectric Strength for 1 Minute	AC	V	≥2000			
	DC	V	≥3000			

CONSTRUCTION PARAMETERS

300V

Conductor		RE-2X(St)H PIMF			
No. of Pairs X Cross Section	Class of Conductor	Nominal Insulation Thickness	Nominal Outer Sheath Thickness	Approx. Overall Diameter	Approx. Weight
mm ²		mm	mm	mm	kg/km
0.5mm ²					
2x2x0.5	2	0.4	1.0	8.6	94
3x2x0.5	2	0.4	1.0	9.0	117
4x2x0.5	2	0.4	1.1	10.1	150
5x2x0.5	2	0.4	1.1	11.0	177
8x2x0.5	2	0.4	1.1	12.9	253
10x2x0.5	2	0.4	1.2	15.3	319
12x2x0.5	2	0.4	1.2	15.8	364
16x2x0.5	2	0.4	1.3	17.7	471
20x2x0.5	2	0.4	1.4	19.4	577
24x2x0.5	2	0.4	1.5	22.3	698
0.75mm ²					
2x2x0.75	2	0.4	1.0	9.2	109
3x2x0.75	2	0.4	1.1	9.9	145
4x2x0.75	2	0.4	1.1	10.8	178
5x2x0.75	2	0.4	1.2	12.0	219
8x2x0.75	2	0.4	1.2	14.1	315
10x2x0.75	2	0.4	1.3	16.8	398
12x2x0.75	2	0.4	1.3	17.3	455
16x2x0.75	2	0.4	1.4	19.4	588
20x2x0.75	2	0.4	1.5	21.2	721
24x2x0.75	2	0.4	1.5	24.2	855
1.0mm ²					
2x2x1.0	2	0.4	1.0	9.9	130
3x2x1.0	2	0.4	1.1	10.7	175
4x2x1.0	2	0.4	1.2	12.0	224
5x2x1.0	2	0.4	1.2	13.1	267
8x2x1.0	2	0.4	1.2	15.4	387
10x2x1.0	2	0.4	1.3	18.3	489
12x2x1.0	2	0.4	1.4	19.1	573
16x2x1.0	2	0.4	1.5	21.4	742

Conductor		RE-2X(St)H PiMF			
No. of Pairs X Cross Section	Class of Conductor	Nominal Insulation Thickness	Nominal Outer Sheath Thickness	Approx. Overall Diameter	Approx. Weight
mm ²		mm	mm	mm	kg/km
20x2x1.0	2	0.4	1.5	23.2	896
24x2x1.0	2	0.4	1.6	26.6	1081
1.5mm ²					
2x2x1.5	2	0.5	1.1	11.8	177
3x2x1.5	2	0.5	1.2	12.7	238
4x2x1.5	2	0.5	1.2	14.0	296
5x2x1.5	2	0.5	1.3	15.5	364
8x2x1.5	2	0.5	1.3	18.3	532
10x2x1.5	2	0.5	1.4	21.8	670
12x2x1.5	2	0.5	1.5	22.8	787
16x2x1.5	2	0.5	1.6	25.5	1020
20x2x1.5	2	0.5	1.7	27.9	1251
24x2x1.5	2	0.5	1.8	32.1	1507

500V

Conductor		RE-2X(St)H PiMF			
No. of Pairs X Cross Section	Class of Conductor	Nominal Insulation Thickness	Nominal Outer Sheath Thickness	Approx. Overall Diameter	Approx. Weight
mm ²		mm	mm	mm	kg/km
0.5mm ²					
2x2x0.5	2	0.6	1.0	10.0	110
3x2x0.5	2	0.6	1.1	10.8	145
4x2x0.5	2	0.6	1.1	11.8	177
5x2x0.5	2	0.6	1.2	13.1	217
8x2x0.5	2	0.6	1.2	15.4	308
10x2x0.5	2	0.6	1.3	18.4	389
12x2x0.5	2	0.6	1.4	19.2	454
16x2x0.5	2	0.6	1.5	21.5	583
20x2x0.5	2	0.6	1.5	23.3	697
24x2x0.5	2	0.6	1.6	26.7	842
0.75mm ²					
2x2x0.75	2	0.6	1.1	10.8	133
3x2x0.75	2	0.6	1.1	11.5	168
4x2x0.75	2	0.6	1.2	12.8	214
5x2x0.75	2	0.6	1.2	14.0	254
8x2x0.75	2	0.6	1.3	16.7	375
10x2x0.75	2	0.6	1.4	19.8	473
12x2x0.75	2	0.6	1.4	20.5	539
16x2x0.75	2	0.6	1.5	23.0	694
20x2x0.75	2	0.6	1.6	25.1	849
24x2x0.75	2	0.6	1.7	28.9	1024
1.0mm ²					
2x2x1.0	2	0.6	1.1	11.6	155



Caledonian

FIRETOX LSZH Flame Retardant Instrumentation & Data Cables

www.caledonian-cables.co.uk www.addison-cables.com

Conductor		RE-2X(St)H PiMF			
No. of Pairs X Cross Section	Class of Conductor	Nominal Insulation Thickness	Nominal Outer Sheath Thickness	Approx. Overall Diameter	Approx. Weight
mm ²		mm	mm	mm	kg/km
3x2x1.0	2	0.6	1.2	12.5	206
4x2x1.0	2	0.6	1.2	13.7	254
5x2x1.0	2	0.6	1.3	15.2	312
8x2x1.0	2	0.6	1.3	17.9	450
10x2x1.0	2	0.6	1.4	21.3	568
12x2x1.0	2	0.6	1.5	22.2	664
16x2x1.0	2	0.6	1.6	25.0	857
20x2x1.0	2	0.6	1.7	27.2	1048
24x2x1.0	2	0.6	1.8	31.3	1263
1.5mm ²					
2x2x1.5	2	0.6	1.1	12.5	187
3x2x1.5	2	0.6	1.2	13.5	251
4x2x1.5	2	0.6	1.3	15.0	321
5x2x1.5	2	0.6	1.3	16.5	384
8x2x1.5	2	0.6	1.4	19.7	573
10x2x1.5	2	0.6	1.5	23.5	721
12x2x1.5	2	0.6	1.6	24.4	845
16x2x1.5	2	0.6	1.7	27.4	1092
20x2x1.5	2	0.6	1.8	29.9	1337
24x2x1.5	2	0.6	1.9	34.4	1609
2.5mm ²					
2x2x2.5	2	0.7	1.2	14.9	263
3x2x2.5	2	0.7	1.3	16.1	357
4x2x2.5	2	0.7	1.4	17.9	457
5x2x2.5	2	0.7	1.5	19.9	562
8x2x2.5	2	0.7	1.6	23.8	840
10x2x2.5	2	0.7	1.7	28.3	1055
12x2x2.5	2	0.7	1.8	29.4	1235
16x2x2.5	2	0.7	1.9	33.0	1598
20x2x2.5	2	0.7	2.1	36.2	1980
24x2x2.5	2	0.7	2.2	41.6	2380



Rated Voltage



Standard



Flame Retardancy
BS EN 60332-1-2



Reduced Fire Propagation
EN 60332-3-24

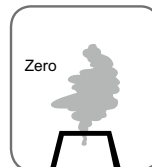

Halogen Free
IEC 60754-1



Low Corrosivity
IEC 60754-2



Low Smoke Emission
IEC 61034-2

LSZH Flame Retardant Overall Screened, Armoured Instrumentation Cables (Multipair)

RE-2X(St)HSAWAH

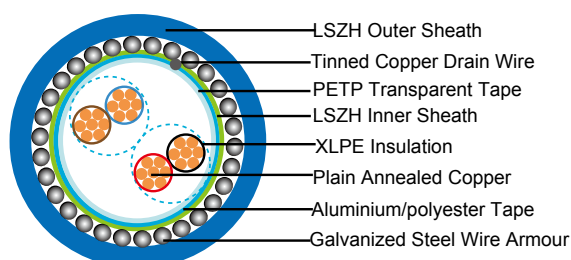

APPLICATION

The LSZH sheathed cables are generally used for indoor installation and suitable for wet and damp areas. The galvanized steel wire armour provides excellent protection. Generally, the cables are used within industrial process manufacturing plants for communication, data and voice transmission signals and services. Also used for the interconnection of electrical equipment and instruments, the LSZH sheath can reduce toxic smoke and fume emission. This product type is TUV approved.

STANDARDS

Basic design to BS EN 50288-7 (formerly BS 5308)



Approvals:

TUV Certification (Z1 17 12 98200 014)

FIRE PERFORMANCE

Flame Retardance (Single vertical wire or cable test)	IEC 60332-1-2; EN 60332-1-2
Reduced Fire Propagation (Vertically-mounted bundled wires & cables test)	IEC 60332-3-24; EN 60332-3-24
Halogen Free	IEC 60754-1; EN 50267-2-1
No Corrosive Gas Emission	IEC 60754-2; EN 50267-2-2
Minimum Smoke Emission	IEC 61034-2; EN 61034-2

VOLTAGE RATING

300V, 500V

CABLE CONSTRUCTION

Conductor: Plain or metal coated copper wire, solid, stranded or flexible according to IEC 60228 class 1, 2 and 5.

Insulation: Extruded XLPE compound according to EN 50290-2-29. LSZH, PE, PP compound can be offered as options.



Caledonian

FIRETOX LSZH Flame Retardant Instrumentation & Data Cables

www.caledonian-cables.co.uk www.addison-cables.com

Pairs: Two insulated conductors uniformly twisted together with a lay not exceeding 100mm ($\leq 1.5\text{mm}^2$) or 150mm (for 2.5mm^2).

Binder tape: PETP transparent tape.

Overall Screen: Aluminium/polyester tape is applied over the laid up pairs with metallic side down in contact with tinned copper drain wire, 0.5mm^2 . Copper braid screen or aluminium/polyester tape combined with copper braid screen can be offered as option.

Inner Sheath: Thermoplastic LSZH compound.

Armouring: Galvanized steel wire armour.

Outer Sheath: Thermoplastic LSZH compound type LTS3 as per BS 7655-6.1 (Thermosetting LSZH compound type SW2-SW4 as per BS 7655-2.6 can be offered).

Outer Sheath Option: UV resistance, hydrocarbon resistance, oil resistance, anti-rodent and anti-termite properties can be offered as option.

COLOUR CODE

Insulation Colour: Colours and/or additional ring markings and/or symbols achieved by the use of coloured insulation or by a coloured surface using extrusion, printing or painting.

Outer Sheath: Black. Other colours can be offered upon request.

PHYSICAL AND THERMAL PROPERTIES

Temperature range during operation: -30°C - $+90^\circ\text{C}$

Temperature range during installation: -5°C - $+50^\circ\text{C}$

Maximum short circuit temperature (5 Seconds): 250°C

Minimum bending radius: 10 x Overall Diameter

ELECTRICAL PROPERTIES

300V

Conductor Area Size	mm ²	0.5	0.75	1.0	1.5
Insulation Thickness (Nominal)	mm	0.4	0.4	0.4	0.5
Insulation Thickness (Minimum)	mm	0.26	0.26	0.26	0.35
Conductor Resistance (20°C)	ohm/km	36.7	25.0	18.5	12.3
Minimum Insulation Resistance (20°C)	Mohm/km	1000			
Maximum Mutual Capacitance	nf/km	250			
Capacitance Unbalance	pf/500m	500			
Maximum L/R (ratio)	$\mu\text{H}/\Omega$	25	25	25	40
Operating Voltage	V	300			
Dielectric Strength for 1 Minute	AC	V	≥ 1000		
	DC	V	≥ 2000		

500V

Conductor Area Size	mm ²	0.5	0.75	1.0	1.5	2.5
Insulation Thickness (Nominal)	mm	0.6	0.6	0.6	0.6	0.7
Insulation Thickness (Minimum)	mm	0.44	0.44	0.44	0.44	0.53
Conductor Resistance (20°C)	ohm/km	36.7	25.0	18.5	12.3	7.4
Minimum Insulation Resistance (20°C)	Mohm/km	1000				
Maximum Mutual Capacitance	nf/km	250				
Capacitance Unbalance	pf/500m	500				
Maximum L/R (ratio)	μH/Ω	25	25	25	40	60
Operating Voltage	V	500				
Dielectric Strength for 1 Minute	AC	≥2000				
	DC	≥3000				

CONSTRUCTION PARAMETERS

300V

Conductor		RE-2X(St)HSAWH					
No. of Pairs X Cross Section	Class of Conductor	Nominal Insulation Thickness	Nominal Inner Sheath Thickness	Nominal Armour Wire Diameter	Nominal Outer Sheath Thickness	Approx. Overall Diameter	Approx. Weight
mm ²		mm	mm	mm	mm	mm	kg/km
0.5mm ²							
1x2x0.5	2	0.4	0.9	0.9	1.3	9.9	215
2x2x0.5	2	0.4	0.9	0.9	1.4	12.3	310
3x2x0.5	2	0.4	1.0	0.9	1.4	12.9	350
4x2x0.5	2	0.4	1.0	0.9	1.4	13.6	390
5x2x0.5	2	0.4	1.1	0.9	1.5	14.9	453
8x2x0.5	2	0.4	1.1	0.9	1.5	16.6	559
10x2x0.5	2	0.4	1.1	0.9	1.5	18.5	659
12x2x0.5	2	0.4	1.2	0.9	1.5	19.2	719
16x2x0.5	2	0.4	1.2	1.25	1.6	21.6	975
20x2x0.5	2	0.4	1.3	1.25	1.6	23.1	1110
24x2x0.5	2	0.4	1.3	1.25	1.7	25.7	1294
0.75mm ²							
1x2x0.75	2	0.4	0.9	0.9	1.3	10.2	233
2x2x0.75	2	0.4	1.0	0.9	1.4	13.1	351
3x2x0.75	2	0.4	1.0	0.9	1.4	13.5	388
4x2x0.75	2	0.4	1.1	0.9	1.5	14.8	456
5x2x0.75	2	0.4	1.1	0.9	1.5	15.7	508
8x2x0.75	2	0.4	1.1	0.9	1.5	17.5	636
10x2x0.75	2	0.4	1.2	1.25	1.6	20.8	903
12x2x0.75	2	0.4	1.2	1.25	1.6	21.3	965
16x2x0.75	2	0.4	1.3	1.25	1.6	23.2	1139



Caledonian

FIRETOX LSZH Flame Retardant Instrumentation & Data Cables

www.caledonian-cables.co.uk www.addison-cables.com

Conductor		RE-2X(St)HSAWAH					
No. of Pairs X Cross Section	Class of Conductor	Nominal Insulation Thickness	Nominal Inner Sheath Thickness	Nominal Armour Wire Diameter	Nominal Outer Sheath Thickness	Approx. Overall Diameter	Approx. Weight
mm ²		mm	mm	mm	mm	mm	kg/km
20x2x0.75	2	0.4	1.4	1.25	1.7	25.0	1320
24x2x0.75	2	0.4	1.4	1.25	1.8	27.9	1539
1.0mm ²							
1x2x1.0	2	0.4	0.9	0.9	1.3	10.6	253
2x2x1.0	2	0.4	1.0	0.9	1.4	13.8	389
3x2x1.0	2	0.4	1.1	0.9	1.5	14.7	454
4x2x1.0	2	0.4	1.1	0.9	1.5	15.6	514
5x2x1.0	2	0.4	1.1	0.9	1.5	16.6	577
8x2x1.0	2	0.4	1.2	0.9	1.5	18.9	749
10x2x1.0	2	0.4	1.2	1.25	1.6	22.2	1036
12x2x1.0	2	0.4	1.3	1.25	1.6	22.9	1133
16x2x1.0	2	0.4	1.4	1.25	1.7	25.2	1364
20x2x1.0	2	0.4	1.4	1.25	1.8	27.0	1563
24x2x1.0	2	0.4	1.5	1.25	1.8	30.2	1833
1.5mm ²							
1x2x1.5	2	0.5	0.9	0.9	1.4	11.8	303
2x2x1.5	2	0.5	1.1	0.9	1.5	15.7	488
3x2x1.5	2	0.5	1.1	0.9	1.5	16.3	552
4x2x1.5	2	0.5	1.2	0.9	1.6	17.9	655
5x2x1.5	2	0.5	1.2	0.9	1.6	19.1	740
8x2x1.5	2	0.5	1.3	1.25	1.6	22.5	1106
10x2x1.5	2	0.5	1.4	1.25	1.7	25.9	1355
12x2x1.5	2	0.5	1.4	1.25	1.7	26.5	1467
16x2x1.5	2	0.5	1.5	1.25	1.8	29.3	1775
20x2x1.5	2	0.5	1.6	1.6	1.9	32.3	2266
24x2x1.5	2	0.5	1.7	1.6	1.9	36.1	2654

500V

Conductor		RE-2X(St)HSAWAH					
No. of Pairs X Cross Section	Class of Conductor	Nominal Insulation Thickness	Nominal Inner Sheath Thickness	Nominal Armour Wire Diameter	Nominal Outer Sheath Thickness	Approx. Overall Diameter	Approx. Weight
mm ²		mm	mm	mm	mm	mm	kg/km
0.5mm ²							
1x2x0.5	2	0.6	0.9	0.9	1.3	10.7	244
2x2x0.5	2	0.6	1.0	0.9	1.4	13.8	370
3x2x0.5	2	0.6	1.0	0.9	1.4	14.3	406
4x2x0.5	2	0.6	1.1	0.9	1.5	15.6	476
5x2x0.5	2	0.6	1.1	0.9	1.5	16.6	529
8x2x0.5	2	0.6	1.2	0.9	1.5	18.9	671
10x2x0.5	2	0.6	1.2	1.25	1.6	22.3	938

Conductor		RE-2X(St)HSAWAH					
No. of Pairs X Cross Section	Class of Conductor	Nominal Insulation Thickness	Nominal Inner Sheath Thickness	Nominal Armour Wire Diameter	Nominal Outer Sheath Thickness	Approx. Overall Diameter	Approx. Weight
mm ²		mm	mm	mm	mm	mm	kg/km
12x2x0.5	2	0.6	1.3	1.25	1.6	23.0	1015
16x2x0.5	2	0.6	1.4	1.25	1.7	25.3	1204
20x2x0.5	2	0.6	1.4	1.25	1.7	26.9	1348
24x2x0.5	2	0.6	1.5	1.25	1.8	30.3	1597
0.75mm ²							
1x2x0.75	2	0.6	0.9	0.9	1.3	11.0	262
2x2x0.75	2	0.6	1.0	0.9	1.4	14.4	401
3x2x0.75	2	0.6	1.1	0.9	1.5	15.4	465
4x2x0.75	2	0.6	1.1	0.9	1.5	16.3	523
5x2x0.75	2	0.6	1.2	0.9	1.5	17.6	599
8x2x0.75	2	0.6	1.2	1.25	1.6	20.8	884
10x2x0.75	2	0.6	1.3	1.25	1.6	23.7	1064
12x2x0.75	2	0.6	1.3	1.25	1.7	24.4	1151
16x2x0.75	2	0.6	1.4	1.25	1.7	26.7	1357
20x2x0.75	2	0.6	1.5	1.25	1.8	28.8	1571
24x2x0.75	2	0.6	1.6	1.6	1.9	33.1	1852
1.0mm ²							
1x2x1.0	2	0.6	0.9	0.9	1.3	11.4	283
2x2x1.0	2	0.6	1.0	0.9	1.4	15.1	440
3x2x1.0	2	0.6	1.1	0.9	1.5	16.1	514
4x2x1.0	2	0.6	1.1	0.9	1.5	17.2	583
5x2x1.0	2	0.6	1.2	0.9	1.6	18.8	681
8x2x1.0	2	0.6	1.2	1.25	1.6	21.9	995
10x2x1.0	2	0.6	1.3	1.25	1.7	25.2	1216
12x2x1.0	2	0.6	1.4	1.25	1.7	26.1	1326
16x2x1.0	2	0.6	1.5	1.25	1.8	28.7	1595
20x2x1.0	2	0.6	1.5	1.25	1.8	30.6	1808
24x2x1.0	2	0.6	1.6	1.6	1.9	35.2	2357
1.5mm ²							
1x2x1.5	2	0.6	0.9	0.9	1.3	12.2	318
2x2x1.5	2	0.6	1.1	0.9	1.5	16.4	515
3x2x1.5	2	0.6	1.2	0.9	1.5	17.3	596
4x2x1.5	2	0.6	1.2	0.9	1.6	18.6	691
5x2x1.5	2	0.6	1.3	1.25	1.6	20.9	919
8x2x1.5	2	0.6	1.3	1.25	1.7	23.8	1182
10x2x1.5	2	0.6	1.4	1.25	1.8	27.4	1449
12x2x1.5	2	0.6	1.5	1.25	1.8	28.3	1589
16x2x1.5	2	0.6	1.6	1.25	1.9	31.2	1918
20x2x1.5	2	0.6	1.7	1.6	2.0	34.3	2442
24x2x1.5	2	0.6	1.8	1.6	2.0	38.5	2859
2.5mm ²							



Caledonian

FIRETOX LSZH Flame Retardant Instrumentation & Data Cables

www.caledonian-cables.co.uk www.addison-cables.com

Conductor		RE-2X(St)HSAWAH					
No. of Pairs X Cross Section	Class of Conductor	Nominal Insulation Thickness	Nominal Inner Sheath Thickness	Nominal Armour Wire Diameter	Nominal Outer Sheath Thickness	Approx. Overall Diameter	Approx. Weight
mm ²		mm	mm	mm	mm	mm	kg/km
1x2x2.5	2	0.7	1.0	0.9	1.4	13.6	394
2x2x2.5	2	0.7	1.2	0.9	1.5	18.6	649
3x2x2.5	2	0.7	1.2	0.9	1.6	19.6	758
4x2x2.5	2	0.7	1.3	1.25	1.6	22.0	1024
5x2x2.5	2	0.7	1.4	1.25	1.7	24.0	1193
8x2x2.5	2	0.7	1.4	1.25	1.7	27.3	1546
10x2x2.5	2	0.7	1.6	1.6	1.9	32.8	2144
12x2x2.5	2	0.7	1.6	1.6	1.9	33.7	2325
16x2x2.5	2	0.7	1.7	1.6	2.0	37.1	2809
20x2x2.5	2	0.7	1.9	1.6	2.1	40.2	3301
24x2x2.5	2	0.7	2.0	1.6	2.2	48.5	3902



Rated Voltage



Standard



Flame Retardancy
BS EN 60332-1-2



Reduced Fire Propagation
EN 60332-3-24

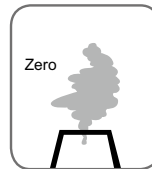

Halogen Free
IEC 60754-1



Low Corrosivity
IEC 60754-2



Low Smoke Emission
IEC 61034-2

LSZH Flame Retardant Individual and Overall Screened, Armoured Instrumentation Cables (Multipair)

RE-2X(St)HSWAH PiMF

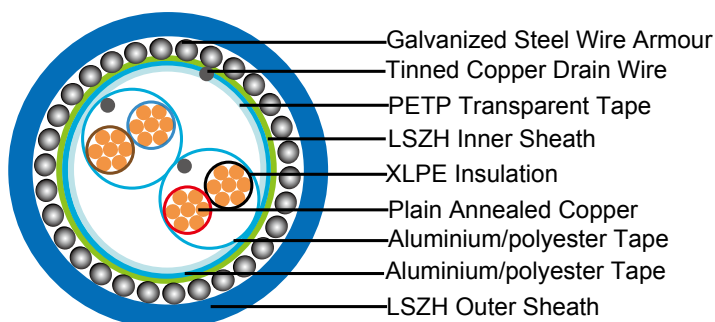

APPLICATION

The armoured LSZH sheathed cables are generally used when the risk of mechanical damage is increased. The galvanized steel wire armour provides excellent protection. Generally, the cables are used within industrial process manufacturing plants for communication, data and voice transmission signals and services. Also used for the interconnection of electrical equipment and instruments, the LSZH sheath can reduce toxic smoke and fume emission. This product type is TUV approved.

STANDARDS

Basic design to BS EN 50288-7 (formerly BS 5308)



Approvals:

TUV Certification (Z1 17 12 98200 014)

FIRE PERFORMANCE

Flame Retardance (Single vertical wire or cable test)	IEC 60332-1-2; EN 60332-1-2
Reduced Fire Propagation (Vertically-mounted bundled wires & cables test)	IEC 60332-3-24; EN 60332-3-24
Halogen Free	IEC 60754-1; EN 50267-2-1
No Corrosive Gas Emission	IEC 60754-2; EN 50267-2-2
Minimum Smoke Emission	IEC 61034-2; EN 61034-2

VOLTAGE RATING

300V, 500V

CABLE CONSTRUCTION

Conductor: Plain or metal coated copper wire, solid, stranded or flexible according to IEC 60228 class 1, 2 and 5.

Insulation: Extruded XLPE compound according to EN 50290-2-29. LSZH, PE, PP compound can be offered as options.



Caledonian

FIRETOX LSZH Flame Retardant Instrumentation & Data Cables

www.caledonian-cables.co.uk www.addison-cables.com

Pairs: Two insulated conductors uniformly twisted together with a lay not exceeding 100mm ($\leq 1.5\text{mm}^2$) or 150mm (for 2.5mm^2).

Individual Screen: Aluminium/polyester tape is applied over the laid up pairs with metallic side down in contact with tinned copper drain wire, 0.5mm^2 .

Binder tape: PETP transparent tape.

Overall Screen: Aluminium/polyester tape is applied over the laid up pairs with metallic side down in contact with tinned copper drain wire, 0.5mm^2 . Copper braid screen or aluminium/polyester tape combined with copper braid screen can be offered as option.

Inner Sheath: Thermoplastic LSZH compound.

Amouring: Galvanized steel wire armour.

Outer Sheath: Thermoplastic LSZH compound according to EN 50290-2-22.

Outer Sheath Option: Thermoplastic LSZH compound. UV resistance, hydrocarbon resistance, oil resistance, anti-rodent and anti-termite properties can be offered as option.

COLOUR CODE

Insulation Colour: Colours and/or additional ring markings and/or symbols achieved by the use of coloured insulation or by a coloured surface using extrusion, printing or painting.

Outer Sheath: Black. Other colours can be offered upon request.

PHYSICAL AND THERMAL PROPERTIES

Temperature range during operation: $-30^\circ\text{C} - +90^\circ\text{C}$

Temperature range during installation: $-5^\circ\text{C} - +50^\circ\text{C}$

Maximum short circuit temperature (5 Seconds): 250°C

Minimum bending radius: 10 x Overall Diameter

ELECTRICAL PROPERTIES

300V

Conductor Area Size	mm ²	0.5	0.75	1.0	1.5
Insulation Thickness (Nominal)	mm	0.4	0.4	0.4	0.5
Insulation Thickness (Minimum)	mm	0.26	0.26	0.26	0.35
Conductor Resistance (20°C)	ohm/km	36.7	25.0	18.5	12.3
Minimum Insulation Resistance (20°C)	Mohm/km	1000			
Maximum Mutual Capacitance	nf/km	250			
Capacitance Unbalance	pf/500m	500			
Maximum L/R (ratio)	$\mu\text{H}/\Omega$	25	25	25	40
Operating Voltage	V	300			
Dielectric Strength for 1 Minute	AC	V	≥ 1000		
	DC	V	≥ 2000		

500V

Conductor Area Size	mm ²	0.5	0.75	1.0	1.5	2.5
---------------------	-----------------	-----	------	-----	-----	-----

Insulation Thickness (nominal)	mm	0.6	0.6	0.6	0.6	0.7
Insulation Thickness (Minimum)	mm	0.44	0.44	0.44	0.44	0.53
Conductor Resistance (20°C)	ohm/km	36.7	25.0	18.5	12.3	7.4
Minimum Insulation Resistance (20°C)	Mohm/km	1000				
Maximum Mutual Capacitance	nf/km	250				
Capacitance Unbalance	pf/500m	500				
Maximum L/R (ratio)	$\mu\text{H}/\Omega$	25	25	25	40	60
Operating Voltage	V	500				
Dielectric Strength for 1 Minute	AC	V	≥ 2000			
	DC	V	≥ 3000			

CONSTRUCTION PARAMETERS

300V

Conductor		RE-2X(St)HSWAH PiMF					
No. of Pairs X Cross Section	Class of Conductor	Nominal Insulation Thickness	Nominal Inner Sheath Thickness	Nominal Armour Wire Diameter	Nominal Outer Sheath Thickness	Approx. Overall Diameter	Approx. Weight
mm ²		mm	mm	mm	mm	mm	kg/km
0.5mm ²							
2x2x0.5	2	0.4	1.0	0.9	1.4	13.2	353
3x2x0.5	2	0.4	1.0	0.9	1.4	13.6	390
4x2x0.5	2	0.4	1.1	0.9	1.5	14.9	458
5x2x0.5	2	0.4	1.1	0.9	1.5	15.8	511
8x2x0.5	2	0.4	1.1	0.9	1.5	17.7	639
10x2x0.5	2	0.4	1.2	1.25	1.6	21.0	908
12x2x0.5	2	0.4	1.2	1.25	1.6	21.5	970
16x2x0.5	2	0.4	1.3	1.25	1.7	23.6	1160
20x2x0.5	2	0.4	1.4	1.25	1.7	25.3	1325
24x2x0.5	2	0.4	1.5	1.25	1.8	28.4	1565
0.75mm ²							
2x2x0.75	2	0.4	1.0	0.9	1.4	13.8	387
3x2x0.75	2	0.4	1.1	0.9	1.5	14.7	450
4x2x0.75	2	0.4	1.1	0.9	1.5	15.6	509
5x2x0.75	2	0.4	1.2	0.9	1.5	16.8	583
8x2x0.75	2	0.4	1.2	0.9	1.6	19.1	747
10x2x0.75	2	0.4	1.3	1.25	1.6	22.5	1040
12x2x0.75	2	0.4	1.3	1.25	1.6	23.2	1129
16x2x0.75	2	0.4	1.4	1.25	1.7	25.3	1338
20x2x0.75	2	0.4	1.5	1.25	1.8	27.3	1550
24x2x0.75	2	0.4	1.5	1.25	1.8	30.3	1793
1.0mm ²							
2x2x1.0	2	0.4	1.0	0.9	1.4	14.5	427
3x2x1.0	2	0.4	1.1	0.9	1.5	15.5	502
4x2x1.0	2	0.4	1.2	0.9	1.5	16.8	584
5x2x1.0	2	0.4	1.2	0.9	1.6	18.1	668
8x2x1.0	2	0.4	1.2	1.25	1.6	21.1	978
10x2x1.0	2	0.4	1.3	1.25	1.7	24.2	1197



Caledonian

FIRETOX LSZH Flame Retardant Instrumentation & Data Cables

www.caledonian-cables.co.uk www.addison-cables.com

Conductor		RE-2X(St)HSWAH PiMF					
No. of Pairs X Cross Section	Class of Conductor	Nominal Insulation Thickness	Nominal Inner Sheath Thickness	Nominal Armour Wire Diameter	Nominal Outer Sheath Thickness	Approx. Overall Diameter	Approx. Weight
mm ²		mm	mm	mm	mm	mm	kg/km
12x2x1.0	2	0.4	1.4	1.25	1.7	25.0	1310
16x2x1.0	2	0.4	1.5	1.25	1.8	27.5	1578
20x2x1.0	2	0.4	1.5	1.25	1.8	29.3	1796
24x2x1.0	2	0.4	1.6	1.6	1.9	33.6	2334
1.5mm ²							
2x2x1.5	2	0.5	1.1	0.9	1.5	16.6	534
3x2x1.5	2	0.5	1.2	0.9	1.6	17.7	630
4x2x1.5	2	0.5	1.2	0.9	1.6	19.0	723
5x2x1.5	2	0.5	1.3	1.25	1.6	21.2	961
8x2x1.5	2	0.5	1.3	1.25	1.7	24.2	1243
10x2x1.5	2	0.5	1.4	1.25	1.8	27.9	1522
12x2x1.5	2	0.5	1.5	1.25	1.8	28.9	1672
16x2x1.5	2	0.5	1.6	1.6	1.9	32.5	2224
20x2x1.5	2	0.5	1.7	1.6	2.0	35.1	2578
24x2x1.5	2	0.5	1.8	1.6	2.0	39.3	3021

500V

Conductor		RE-2X(St)HSWAH PiMF					
No. of Pairs X Cross Section	Class of Conductor	Nominal Insulation Thickness	Nominal Inner Sheath Thickness	Nominal Armour Wire Diameter	Nominal Outer Sheath Thickness	Approx. Overall Diameter	Approx. Weight
mm ²		mm	mm	mm	mm	mm	kg/km
0.5mm ²							
2x2x0.5	2	0.6	1.0	0.9	1.4	14.6	409
3x2x0.5	2	0.6	1.1	0.9	1.5	15.6	473
4x2x0.5	2	0.6	1.1	0.9	1.5	16.6	533
5x2x0.5	2	0.6	1.2	0.9	1.6	18.1	620
8x2x0.5	2	0.6	1.2	1.25	1.6	21.1	900
10x2x0.5	2	0.6	1.3	1.25	1.7	24.3	1098
12x2x0.5	2	0.6	1.4	1.25	1.7	25.1	1192
16x2x0.5	2	0.6	1.5	1.25	1.8	27.6	1422
20x2x0.5	2	0.6	1.5	1.25	1.8	29.4	1600
24x2x0.5	2	0.6	1.6	1.6	1.9	33.7	2099
0.75mm ²							
2x2x0.75	2	0.6	1.1	0.9	1.5	15.6	463
3x2x0.75	2	0.6	1.1	0.9	1.5	16.3	516
4x2x0.75	2	0.6	1.2	0.9	1.6	17.8	607
5x2x0.75	2	0.6	1.2	0.9	1.6	19.0	681
8x2x0.75	2	0.6	1.3	1.25	1.6	22.4	1012
10x2x0.75	2	0.6	1.4	1.25	1.7	25.7	1237
12x2x0.75	2	0.6	1.4	1.25	1.7	26.4	1326
16x2x0.75	2	0.6	1.5	1.25	1.8	29.1	1588
20x2x0.75	2	0.6	1.6	1.6	1.9	32.1	2033
24x2x0.75	2	0.6	1.7	1.6	2.0	36.1	2394

Conductor		RE-2X(St)HSAWAH PiMF					
No. of Pairs X Cross Section	Class of Conductor	Nominal Insulation Thickness	Nominal Inner Sheath Thickness	Nominal Armour Wire Diameter	Nominal Outer Sheath Thickness	Approx. Overall Diameter	Approx. Weight
mm ²		mm	mm	mm	mm	mm	kg/km
1.0mm ²							
2x2x1.0	2	0.6	1.1	0.9	1.5	16.4	505
3x2x1.0	2	0.6	1.2	0.9	1.5	17.3	581
4x2x1.0	2	0.6	1.2	0.9	1.6	18.7	672
5x2x1.0	2	0.6	1.3	1.25	1.6	20.9	896
8x2x1.0	2	0.6	1.3	1.25	1.7	23.8	1144
10x2x1.0	2	0.6	1.4	1.25	1.7	27.2	1386
12x2x1.0	2	0.6	1.5	1.25	1.8	28.3	1531
16x2x1.0	2	0.6	1.6	1.6	1.9	32.0	2035
20x2x1.0	2	0.6	1.7	1.6	1.9	34.2	2326
24x2x1.0	2	0.6	1.8	1.6	2.0	38.5	2743
1.5mm ²							
2x2x1.5	2	0.6	1.1	0.9	1.5	17.3	563
3x2x1.5	2	0.6	1.2	0.9	1.6	18.5	665
4x2x1.5	2	0.6	1.3	0.9	1.6	20.0	778
5x2x1.5	2	0.6	1.3	1.25	1.7	22.4	1027
8x2x1.5	2	0.6	1.4	1.25	1.7	25.6	1333
10x2x1.5	2	0.6	1.5	1.25	1.8	29.6	1632
12x2x1.5	2	0.6	1.6	1.25	1.9	30.7	1809
16x2x1.5	2	0.6	1.7	1.6	2.0	34.6	2397
20x2x1.5	2	0.6	1.8	1.6	2.0	37.1	2754
24x2x1.5	2	0.6	1.9	1.6	2.1	41.8	3251
2.5mm ²							
2x2x2.5	2	0.7	1.2	0.9	1.6	19.9	718
3x2x2.5	2	0.7	1.3	1.25	1.0	21.8	972
4x2x2.5	2	0.7	1.4	1.25	1.7	23.8	1150
5x2x2.5	2	0.7	1.5	1.25	1.8	26.0	1341
8x2x2.5	2	0.7	1.6	1.25	1.8	29.9	1762
10x2x2.5	2	0.7	1.7	1.6	2.0	35.5	2400
12x2x2.5	2	0.7	1.8	1.6	2.0	36.6	2631
16x2x2.5	2	0.7	1.9	1.6	2.1	40.4	3176
20x2x2.5	2	0.7	2.1	1.6	2.2	43.8	3728
24x2x2.5	2	0.7	2.2	1.6	2.4	49.6	4433



Rated Voltage

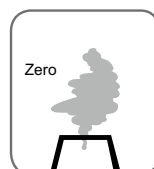
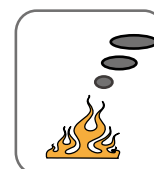

Standard

Flame Retardancy
BS EN 60332-1-2Reduced Fire Propagation
EN 60332-3-24Halogen Free
IEC 60754-1Low Corrosivity
IEC 60754-2Low Smoke Emission
IEC 61034-2



Caledonian

FIRETOX LSZH Flame Retardant Instrumentation & Data Cables

www.caledonian-cables.co.uk www.addison-cables.com

LSZH Flame Retardant CAT5E Data Cables

FTX-CAT5EU/UTP4P24LH

FTX-CAT5EF/UTP4P24LH

FTX-CAT5ESF/UTP4P24LH

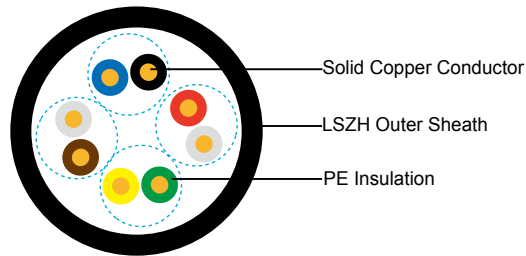

APPLICATION

U/UTP CAT5E

Cat5E is a cable standard for Gigabit Ethernet and other network protocol, suitable for basic voice and data installations up to 100 MHz. In addition, these cables can be offered with copper wire braid armoured & flame retardant outer sheath, providing additional mechanically protection still maintaining the flexibility of the cable.

STANDARDS

ISO/IEC 11801 EN 50173 ANSI/TIA/EIA 568



Approvals:

ETL Certification (103488703CRT-001b,103488703CRT-001c)

FIRE PERFORMANCE

Flame Retardance (Single vertical wire or cable test)	IEC 60332-1-2; EN 60332-1-2
Reduced Fire Propagation (Vertically-mounted bundled wires & cables test)	IEC 60332-3-24; EN 60332-3-24
Halogen Free	IEC 60754-1; EN 50267-2-1
No Corrosive Gas Emission	IEC 60754-2; EN 50267-2-2
Minimum Smoke Emission	IEC 61034-2; EN 61034-2

CABLE CONSTRUCTION

Conductors: 24AWG solid bare copper.

Insulation: PE.

Twinning: Two coloured insulated conductors twisted together to form a pair.

Outer Sheath: Thermoplastic LSZH compound type LTS3 as per BS 7655-6.1 (Thermosetting LSZH compound type SW2-SW4 as per BS 7655-2.6 can be offered).

Outer Sheath Option: UV resistance, hydrocarbon resistance, oil resistance, anti-rodent and anti-termite properties can be offered as option.

Cat5EF/UTP: These cables have collective shielding of Aluminium/polyester tape with drain wire.

Cat5ESF/UTP: These cables have double collective shielding of Aluminium/polyester tape & copper wire braid.

PHYSICAL AND THERMAL PROPERTIES

Temperature range: -30°C - +75°C

Minimum bending radius during installation (mobile state): 8 x Overall Diameter

Minimum bending radius during operation (fixed state): 4 x Overall Diameter

ELECTRICAL PROPERTIES

AWG		24
Nominal Conductor Diameter	mm	0.50/0.51/0.53
Maximum DC Resistance@20°C	Ω/100m	9.38
Maximum DCR Unbalance	%	5
Maximum Mutual Capacitance	pF/m	55.8
Maximum Capacitance Unbalance	pF/100m	330
Characteristic Impedance@1-100MHz	Ω	100±15
Maximum Propagation Delay Skew	ns/100m	45

TRANSMISSION PROPERTIES

FREQ MHz	Attenuation dB/100m	NEXT dB	PSNEXT dB	ELFEXT dB/100m	PSELFEXT dB/100m	RL dB
0.772	1.8	67.0	64.0	66.0	63.0	—
1	2.0	65.3	62.3	63.8	60.8	20.0
4	4.1	56.3	53.3	51.7	48.7	23.0
8	5.8	51.8	48.8	45.7	42.7	24.5
10	6.5	50.3	47.3	43.8	40.8	25.0
16	8.2	47.3	44.3	39.7	36.7	25.0
20	9.3	45.8	42.8	37.7	34.7	25.0
25	10.4	44.3	41.3	35.8	32.8	24.3
31.25	11.7	42.9	39.9	33.9	30.9	23.6
62.5	17.0	38.4	35.4	27.8	24.8	21.5
100	22.0	35.3	32.3	23.8	20.8	20.1

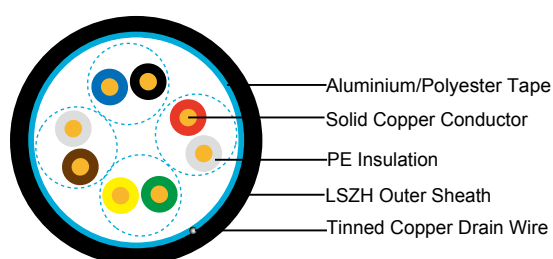

F/UTP CAT5E

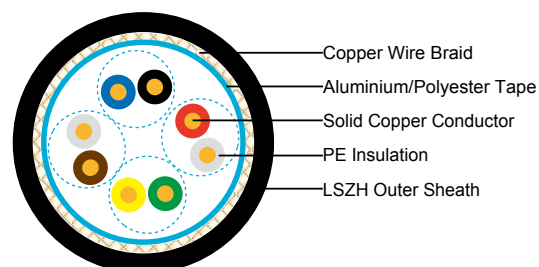

SF/UTP CAT5E



Caledonian

FIRETOX LSZH Flame Retardant Instrumentation & Data Cables

www.caledonian-cables.co.uk www.addison-cables.com

CONSTRUCTION PARAMETERS

Cable Code	Conductor Diameter	Diameter Over Insulation	Pairs	Screen	Approx. Overall Diameter
	mm	mm			mm
FTX-CAT5EU/UTP4P24LH	0.50/0.51	0.91	4	Nil	5.1
FTX-CAT5EF/UTP4P24LH	0.53	1.00	4	Overall Aluminum Tape Screen	6.3
FTX-CAT5ESF/UTP4P24LH	0.53	1.00	4	Overall Aluminum Tape Screen & Copper Wire Braid	6.6



Standard



Flame Retardancy
BS EN 60332-1-2



Reduced Fire Propagation
EN 60332-3-24

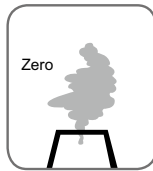

Halogen Free
IEC 60754-1



Low Corrosivity
IEC 60754-2



Low Smoke Emission
IEC 61034-2

LSZH Flame Retardant CAT5E CWB/SWB/SWA Armoured Data Cables

FTX-CAT5EU/UTP4P24LH CWB/SWB/SWA

FTX-CAT5EF/UTP4P24LH CWB/SWB/SWA

FTX-CAT5ESF/UTP4P24LH CWB/SWB/SWA

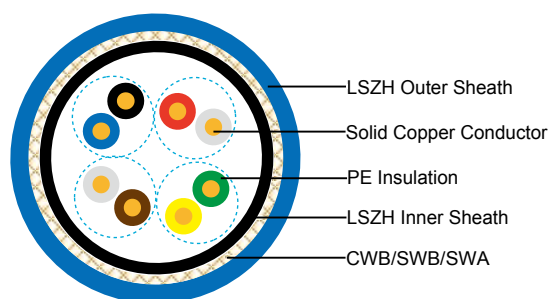

U/UTP CAT5E

APPLICATION

Cat5E is a cable standard for Gigabit Ethernet and other network protocol, suitable for basic voice and data installations up to 100 MHz. In addition, these cables can be offered with copper wire braid armoured & flame retardant outer sheath, providing additional mechanical protection still maintaining the flexibility of the cable.

STANDARDS

ISO/IEC 11801 EN 50173 ANSI/TIA/EIA 568

FIRE PERFORMANCE

Flame Retardance (Single vertical wire or cable test)	IEC 60332-1-2; EN 60332-1-2
Reduced Fire Propagation (Vertically-mounted bundled wires & cables test)	IEC 60332-3-24; EN 60332-3-24
Halogen Free	IEC 60754-1; EN 50267-2-1
No Corrosive Gas Emission	IEC 60754-2; EN 50267-2-2
Minimum Smoke Emission	IEC 61034-2; EN 61034-2

CABLE CONSTRUCTION

Conductors: 24AWG solid bare copper.

Insulation: PE.

Twinning: Two coloured insulated conductors twisted together to form a pair.

Inner Sheath: Thermoplastic LSZH compound.

Armouring:

CWB: Copper Wire Braid

SWB: Steel Wire Braid

SWA: Steel Wire Armour

Outer Sheath: Thermoplastic LSZH compound type LTS3 as per BS 7655-6.1 (Thermosetting LSZH



Caledonian

FIRETOX LSZH Flame Retardant Instrumentation & Data Cables

www.caledonian-cables.co.uk www.addison-cables.com

compound type SW2-SW4 as per BS 7655-2.6 can be offered).

Outer Sheath Option: UV resistance, hydrocarbon resistance, oil resistance, anti-rodent and anti-termite properties can be offered as option.

Cat5EF/UTP: These cables have collective shielding of Aluminium/polyester tape with drain wire.

Cat5ESF/UTP: These cables have double collective shielding of Aluminium/polyester tape & copper wire braid.

PHYSICAL AND THERMAL PROPERTIES

Temperature range: -30°C - +75°C

Minimum bending radius during installation (mobile state): 8 x Overall Diameter

Minimum bending radius during operation (fixed state): 4 x Overall Diameter

ELECTRICAL PROPERTIES

AWG		24
Nominal Conductor Diameter	mm	0.50/0.53
Maximum DC Resistance@20°C	Ω/100m	9.38
Maximum DCR Unbalance	%	5
Maximum Mutual Capacitance	pF/m	55.8
Maximum Capacitance Unbalance	pF/100m	330
Characteristic Impedance@1-100MHz	Ω	100±15
Maximum Propagation Delay Skew	ns/100m	45

TRANSMISSION PROPERTIES

FREQ MHz	Attenuation dB/100m	NEXT dB	PSNEXT dB	ELFEXT dB/100m	PSELFEXT dB/100m	RL dB
0.772	1.8	67.0	64.0	66.0	63.0	—
1	2.0	65.3	62.3	63.8	60.8	20.0
4	4.1	56.3	53.3	51.7	48.7	23.0
8	5.8	51.8	48.8	45.7	42.7	24.5
10	6.5	50.3	47.3	43.8	40.8	25.0
16	8.2	47.3	44.3	39.7	36.7	25.0
20	9.3	45.8	42.8	37.7	34.7	25.0
25	10.4	44.3	41.3	35.8	32.8	24.3
31.25	11.7	42.9	39.9	33.9	30.9	23.6
62.5	17.0	38.4	35.4	27.8	24.8	21.5
100	22.0	35.3	32.3	23.8	20.8	20.1

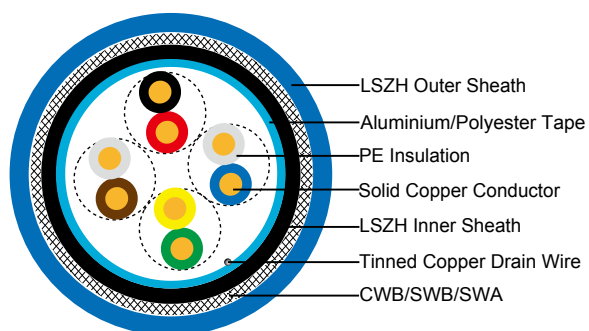

F/UTP CAT5E

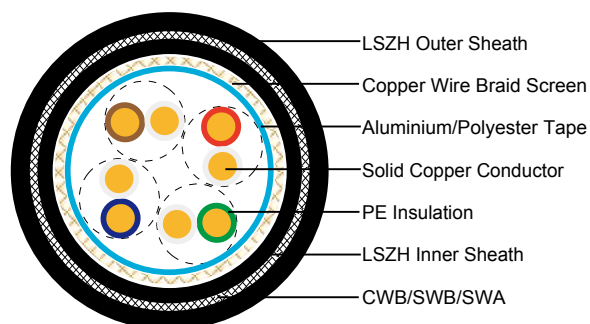

SF/UTP CAT5E

CONSTRUCTION PARAMETERS

Cable Code	Conductor Diameter	Nominal Insulation Thickness	Nominal Inner Sheath Thickness	Nominal Outer Sheath Thickness	Approx. Overall Diameter	Nominal Weight
	mm	mm	mm	mm	mm	kg/km
FTX-CAT5EU/UTP4P24LH CWB	4×2×0.5	0.2	0.6	1.0	7.68	102
FTX-CAT5EU/UTP4P24LH SWB	4×2×0.5	0.2	0.6	1.0	7.68	98
FTX-CAT5EU/UTP4P24LH SWA	4×2×0.5	0.2	0.6	1.0	8.68	170
FTX-CAT5EF/UTP4P24LH CWB	4×2×0.53	0.2	0.6	1.0	8.28	121
FTX-CAT5EF/UTP4P24LH SWB	4×2×0.53	0.2	0.6	1.0	8.28	117
FTX-CAT5EF/UTP4P24LH SWA	4×2×0.53	0.2	0.6	1.0	9.28	197
FTX-CAT5ESF/UTP4P24LH CWB	4×2×0.53	0.2	0.6	1.0	8.76	128
FTX-CAT5ESF/UTP4P24LH SWB	4×2×0.53	0.2	0.6	1.0	8.76	124
FTX-CAT5ESF/UTP4P24LH SWA	4×2×0.53	0.2	0.6	1.0	9.76	221



Standard



Flame Retardancy
BS EN 60332-1-2



Reduced Fire Propagation
EN 60332-3-24

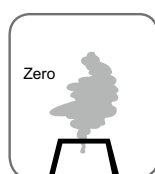

Halogen Free
IEC 60754-1



Low Corrosivity
IEC 60754-2

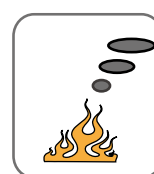

Low Smoke Emission
IEC 61034-2



Caledonian

FIRETOX LSZH Flame Retardant Instrumentation & Data Cables

www.caledonian-cables.co.uk www.addison-cables.com

LSZH Flame Retardant CAT6 Data Cables

FTX-CAT6U/UTP4P23LH

FTX-CAT6F/UTP4P23LH

FTX-CAT6SF/UTP4P23LH

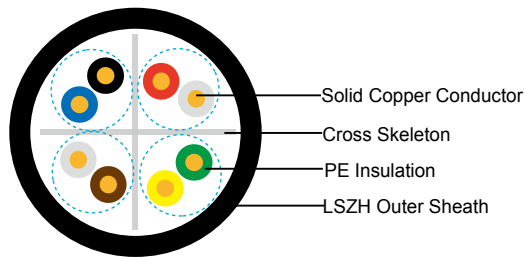

U/UTP CAT6

APPLICATION

Cat6 Cable is a cable standard for Gigabit Ethernet and other network protocol, suitable for 10BaseT, 100BaseTx & 1000BaseT (Gigabit Ethernet) application. In addition, these cables can be offered with copper wire braid armoured & flame retardant outer sheath, providing additional mechanical protection still maintaining the flexibility of the cable.

STANDARDS

ISO/IEC 11801 EN 50173 ANSI/TIA/EIA 568



Approvals:

ETL Certification (103488703CRT-001a, 103488703CRT-001d,)

FIRE PERFORMANCE

Flame Retardance (Single vertical wire or cable test)	IEC 60332-1-2; EN 60332-1-2
Reduced Fire Propagation (Vertically-mounted bundled wires & cables test)	IEC 60332-3-24; EN 60332-3-24
Halogen Free	IEC 60754-1; EN 50267-2-1
No Corrosive Gas Emission	IEC 60754-2; EN 50267-2-2
Minimum Smoke Emission	IEC 61034-2; EN 61034-2

CABLE CONSTRUCTION

Conductors: 23AWG solid bare copper.

Insulation: PE.

Twinning: Two coloured insulated conductors twisted together to form a pair.

Outer Sheath: Thermoplastic LSZH compound type LTS3 as per BS 7655-6.1 (Thermosetting LSZH compound type SW2-SW4 as per BS 7655-2.6 can be offered).

Outer Sheath Option: UV resistance, hydrocarbon resistance, oil resistance, anti-rodent and anti-termite properties can be offered as option.

Cat6 F/UTP: These cables have collective shielding of Aluminium/polyester tape with drain wire.

Cat6 SF/UTP: These cables have double collective shielding of Aluminium/polyester tape & copper wire braid.

PHYSICAL AND THERMAL PROPERTIES

Temperature range: -30°C - +75°C

Minimum bending radius during installation (mobile state): 8 x Overall Diameter

Minimum bending radius during operation (fixed state): 4 x Overall Diameter

ELECTRICAL PROPERTIES

AWG		23
Nominal Conductor Diameter	mm	0.56/0.57/0.58
Maximum DC Resistance@20°C	Ω/100m	9.38
Maximum DCR Unbalance	%	3
Maximum Mutual Capacitance	pF/m	5.8
Maximum Capacitance Unbalance	pF/100m	30
Characteristic Impedance@1-100MHz	Ω	100±15
Maximum Propagation Delay Skew	ns/100m	18

TRANSMISSION PROPERTIES

FREQ MHz	Attenuation dB/100m	NEXT dB	PSNEXT dB	ELFEXT dB/100m	PSELFEXT dB/100m	RL dB
0.772	1.8	76.0	74.	70.0	67.0	—
1	2.0	74.3	72.3	67.8	64.8	20.0
4	3.8	65.3	63.3	55.7	52.7	23.0
8	5.3	60.8	58.8	49.7	46.7	24.5
10	6.0	59.3	57.3	47.8	44.8	25.0
16	7.6	56.3	54.3	43.7	40.7	25.0
20	8.5	54.8	52.8	41.7	38.7	25.0
25	9.5	53.3	51.3	39.8	36.8	24.3
31.25	10.7	51.9	49.9	37.9	34.9	23.6
62.5	15.4	47.4	45.4	31.8	28.8	21.5
100	19.8	44.3	42.3	27.8	24.8	20.1
155	25.2	41.5	39.5	23.9	20.9	18.8
200	29.0	39.8	37.8	21.7	18.7	18.0
250	32.8	38.3	36.3	19.8	16.8	17.3



Caledonian

FIRETOX LSZH Flame Retardant Instrumentation & Data Cables

www.caledonian-cables.co.uk www.addison-cables.com

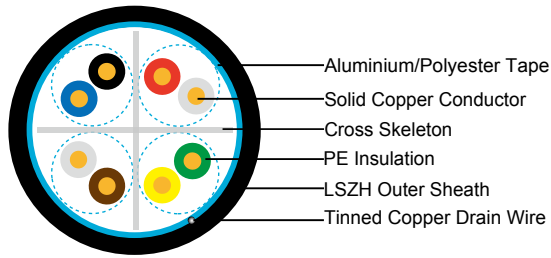

F/UTP CAT6

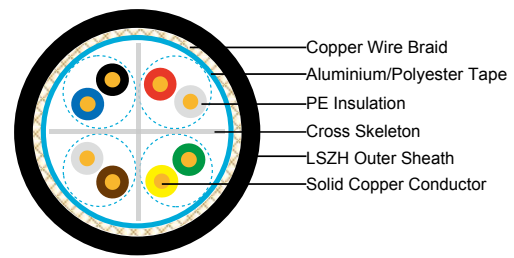

SF/UTP CAT6

CONSTRUCTION PARAMETERS

Cable Code	Conductor Diameter	Diameter Over Insulation	Pairs	Screen	Approx. Overall Diameter
	mm	mm			mm
FTX-CAT6U/UTP4P23LH	0.56/0.57	1.02	4	Nil	6.0
FTX-CAT6F/UTP4P23LH	0.57/0.58	1.02	4	Overall Aluminum Tape Screen	6.3
FTX-CAT6SF/UTP4P23LH	0.57/0.58	1.02	4	Overall Aluminum Tape Screen & Copper Wire Braid	6.6



Standard



Flame Retardancy
BS EN 60332-1-2



Reduced Fire Propagation
EN 60332-3-24

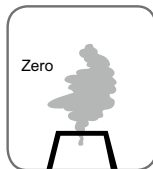

Halogen Free
IEC 60754-1



Low Corrosivity
IEC 60754-2

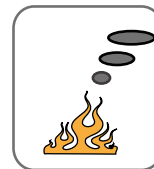

Low Smoke Emission
IEC 61034-2

LSZH Flame Retardant CAT6 CWB/SWB/SWA Armoured Data Cables

FTX-CAT6U/UTP4P23LH CWB/SWB/SWA

FTX-CAT6F/UTP4P23LH CWB/SWB/SWA

FTX-CAT6SF/UTP4P23LH CWB/SWB/SWA

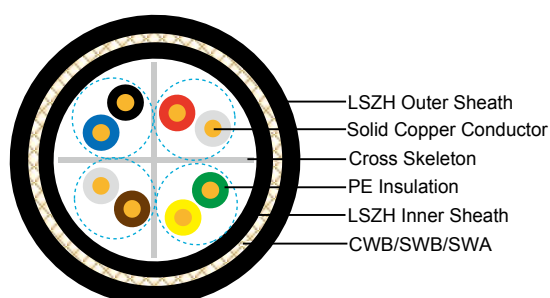

U/UTP CAT6

APPLICATION

Cat6 Cable is a cable standard for Gigabit Ethernet and other network protocol, suitable for 10BaseT, 100BaseTx & 1000BaseT (Gigabit Ethernet) application. In addition, these cables can be offered with copper wire braid armoured & flame retardant outer sheath, providing additional mechanical protection still maintaining the flexibility of the cable.

STANDARDS

ISO/IEC 11801 EN 50173 ANSI/TIA/EIA 568

FIRE PERFORMANCE

Flame Retardance (Single vertical wire or cable test)	IEC 60332-1-2; EN 60332-1-2
Reduced Fire Propagation (Vertically-mounted bundled wires & cables test)	IEC 60332-3-24; EN 60332-3-24
Halogen Free	IEC 60754-1; EN 50267-2-1
No Corrosive Gas Emission	IEC 60754-2; EN 50267-2-2
Minimum Smoke Emission	IEC 61034-2; EN 61034-2

CABLE CONSTRUCTION

Conductors: 23AWG solid bare copper.

Insulation: PE .

Twinning: Two coloured insulated conductors twisted together to form a pair.

Inner Sheath: Thermoplastic LSZH compound, coloured black.

Armouring:

CWB: Copper Wire Braid

SWB: Steel Wire Braid

SWA: Steel Wire Armour

Outer Sheath: Thermoplastic LSZH compound type LTS3 as per BS 7655-6.1 (Thermosetting LSZH



Caledonian

FIRETOX LSZH Flame Retardant Instrumentation & Data Cables

www.caledonian-cables.co.uk www.addison-cables.com

compound type SW2-SW4 as per BS 7655-2.6 can be offered).

Outer Sheath Option: UV resistance, hydrocarbon resistance, oil resistance, anti-rodent and anti-termite properties can be offered as option.

Cat6F/UTP: These cables have collective shielding of Aluminium/polyester tape with drain wire.

Cat6SF/UTP: These cables have double collective shielding of Aluminium/polyester tape & copper wire braid.

PHYSICAL AND THERMAL PROPERTIES

Temperature range: -30°C - +75°C

Minimum bending radius during installation (mobile state): 8 x Overall Diameter

Minimum bending radius during operation (fixed state): 4 x Overall Diameter

ELECTRICAL PROPERTIES

AWG		23
Nominal Conductor Diameter	mm	0.56/0.57/0.58
Maximum DC Resistance@20°C	Ω/100m	9.38
Maximum DCR Unbalance	%	3
Maximum Mutual Capacitance	pF/m	5.8
Maximum Capacitance Unbalance	pF/100m	30
Characteristic Impedance@1-100MHz	Ω	100±15
Maximum Propagation Delay Skew	ns/100m	18

TRANSMISSION PROPERTIES

FREQ MHz	Attenuation dB/100m	NEXT dB	PSNEXT dB	ELFEXT dB/100m	PSELFEXT dB/100m	RL dB
0.772	1.8	76.0	74.0	70.0	67.0	—
1	2.0	74.3	72.3	67.8	64.8	20.0
4	3.8	65.3	63.3	55.7	52.7	23.0
8	5.3	60.8	58.8	49.7	46.7	24.5
10	6.0	59.3	57.3	47.8	44.8	25.0
16	7.6	56.3	54.3	43.7	40.7	25.0
20	8.5	54.8	52.8	41.7	38.7	25.0
25	9.5	53.3	51.3	39.8	36.8	24.3
31.25	10.7	51.9	49.9	37.9	34.9	23.6
62.5	15.4	47.4	45.4	31.8	28.8	21.5
100	19.8	44.3	42.3	27.8	24.8	20.1
155	25.2	41.5	39.5	23.9	20.9	18.8
200	29.0	39.8	37.8	21.7	18.7	18.0
250	32.8	38.3	36.3	19.8	16.8	17.3

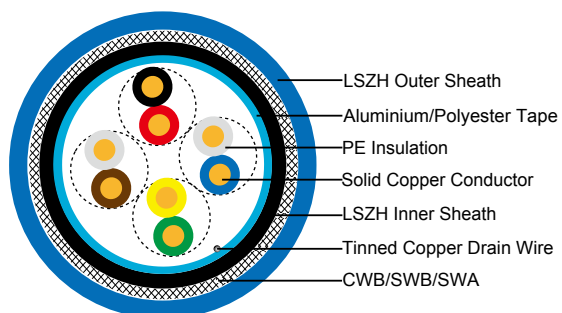

F/UTP CAT6

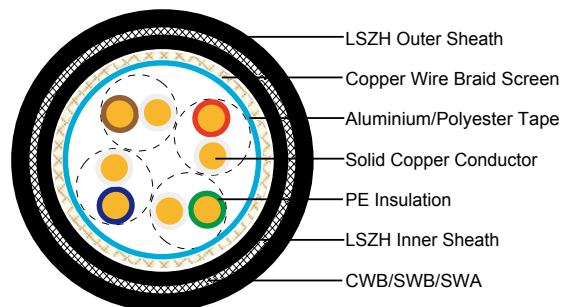

SF/UTP CAT6

CONSTRUCTION PARAMETERS

Cable Code	Conductor Diameter	Nominal Insulation Thickness	Nominal Inner Sheath Thickness	Nominal Outer Sheath Thickness	Approx. Overall Diameter	Nominal Weight
	mm	mm	mm	mm	mm	kg/km
FTX-CAT6U/UTP4P23LH CWB	4×2×0.56/0.57	0.2	0.6	1.0	7.88	120
FTX-CAT6U/UTP4P23LH SWB	4×2×0.56/0.57	0.2	0.6	1.0	7.88	114
FTX-CAT6U/UTP4P23LH SWA	4×2×0.56/0.57	0.2	0.6	1.0	8.88	194
FTX-CAT6F/UTP4P23LH CWB	4×2×0.57/0.58	0.2	0.6	1.0	8.48	131
FTX-CAT6F/UTP4P23LH SWB	4×2×0.57/0.58	0.2	0.6	1.0	8.48	137
FTX-CAT6F/UTP4P23LH SWA	4×2×0.57/0.58	0.2	0.6	1.0	9.48	218
FTX-CAT6SF/UTP4P23LH CWB	4×2×0.57/0.58	0.2	0.6	1.0	8.96	159
FTX-CAT6SF/UTP4P23LH SWB	4×2×0.57/0.58	0.2	0.6	1.0	8.96	153
FTX-CAT6SF/UTP4P23LH SWA	4×2×0.57/0.58	0.2	0.6	1.0	9.96	247



Standard



Flame Retardancy
BS EN 60332-1-2



Reduced Fire Propagation
EN 60332-3-24

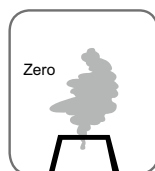

Halogen Free
IEC 60754-1



Low Corrosivity
IEC 60754-2

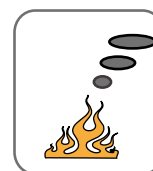

Low Smoke Emission
IEC 61034-2



Caledonian

FIRETOX LSZH Flame Retardant Instrumentation & Data Cables

www.caledonian-cables.co.uk www.addison-cables.com

LSZH Flame Retardant RS 485 Databus Cables

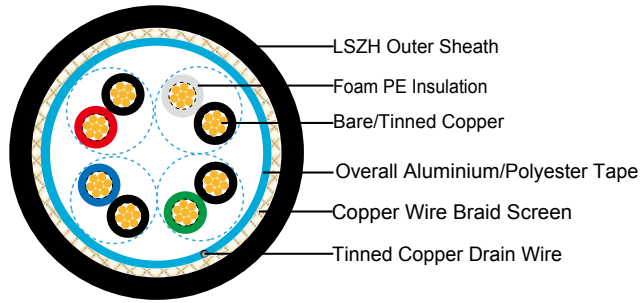
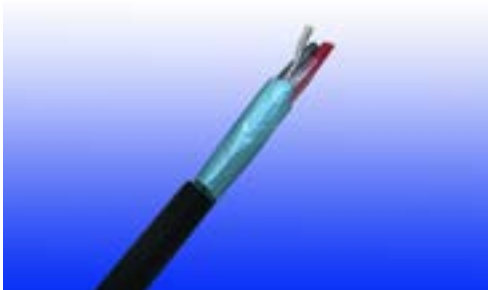

RS 485

APPLICATION

The cables are designed for RS 485 data connections where continued functionality is required during a fire situation. This cable combines low capacitance insulation with one of the highest levels of screening to provide high speed, interference free, data transmission where continued functionality is required during a fire situation.

STANDARDS

Basic design adapted to EIA/TIA 485

FIRE PERFORMANCE

Flame Retardance (Single vertical wire or cable test)	IEC 60332-1-2; EN 60332-1-2
Reduced Fire Propagation (Vertically-mounted bundled wires & cables test)	IEC 60332-3-24; EN 60332-3-24
Halogen Free	IEC 60754-1; EN 50267-2-1
No Corrosive Gas Emission	IEC 60754-2; EN 50267-2-2
Minimum Smoke Emission	IEC 61034-2; EN 61034-2

CABLE CONSTRUCTION

MULTIPAIR RS 485 OVERALL SCREENED DATABUS CABLE

Conductors: Tinned copper wire, stranded according to IEC 60228 class 2 or class 5.

Insulation: Foam PE or foam skin PE.

Cabling Elements: Insulated cores are twisted to form pairs with varying lay length to minimize crosstalk.

Two pair cable had four cores laid in quad formation.

Cabling: Pairs are cabled together in concentric layers.

Overall Screen: Aluminum/polyester tape with tinned copper drain wire.

Outer Sheath: Thermoplastic LSZH compound type LTS3 as per BS 7655-6.1 (Thermosetting LSZH compound type SW2-SW4 as per BS 7655-2.6 can be offered).

Outer Sheath Option: UV resistance, hydrocarbon resistance, oil resistance, anti-rodent and anti-termite properties can be offered as option.

MULTIPAIR RS 485 OVERALL DOUBLE SCREENED DATABUS CABLE

Conductors: Tinned copper wire, stranded according to IEC 60228 class 2 or class 5.

Insulation: Foam PE or foam skin PE.

Cabling Elements: Insulated cores are twisted to form pairs with varying lay length to minimize crosstalk. Two pair cable had four cores laid in quad formation.

Cabling: Pairs are cabled together in concentric layers.

Overall Screen: Aluminium/polyester tape+copper wire braid.

Outer Sheath: Thermoplastic LSZH compound type LTS3 as per BS 7655-6.1 (Thermosetting LSZH compound type SW2-SW4 as per BS 7655-2.6 can be offered).

Outer Sheath Option: UV resistance, hydrocarbon resistance, oil resistance, anti-rodent and anti-termite properties can be offered as option.

MULTIPAIR RS 485 INDIVIDUAL & OVERALL SCREENED DATABUS CABLE

Conductors: Tinned copper wire, stranded according to IEC 60228 class 2 or class 5.

Insulation: Foam PE or foam skin PE.

Cabling Elements: Insulated cores are twisted to form pairs with varying lay length to minimize crosstalk. Two pair cable had four cores laid in quad formation.

Cabling: Pairs are cabled together in concentric layers.

Individual Screen: Individual aluminium/polyester tape.

Overall Screen: Copper wire braid.

Outer Sheath: Thermoplastic LSZH compound type LTS3 as per BS 7655-6.1 (Thermosetting LSZH compound type SW2-SW4 as per BS 7655-2.6 can be offered).

Outer Sheath Option: UV resistance, hydrocarbon resistance, oil resistance, anti-rodent and anti-termite properties can be offered as option.

MULTIPAIR RS 485 OVERALL SCREENED DATABUS CABLE

Conductors: Tinned copper wire, stranded according to IEC 60228 class 2 or class 5.

Insulation: Foam PE or foam skin PE.

Cabling Elements: Insulated cores are twisted to form pairs with varying lay length to minimize crosstalk. Two pair cable had four cores laid in quad formation.

Cabling: Pairs are cabled together in concentric layers.

Overall Screen: Copper wire braid.

Outer Sheath: Thermoplastic LSZH compound type LTS3 as per BS 7655-6.1 (Thermosetting LSZH compound type SW2-SW4 as per BS 7655-2.6 can be offered).



Caledonian

FIRETOX LSZH Flame Retardant Instrumentation & Data Cables

www.caledonian-cables.co.uk www.addison-cables.com

Outer Sheath Option: UV resistance, hydrocarbon resistance, oil resistance, anti-rodent and anti-termite properties can be offered as option.

PHYSICAL AND THERMAL PROPERTIES

Temperature range during operation (fixed state): -20°C - +90°C

Temperature range during installation (mobile state): -5°C - +60°C

Minimum bending radius: 8 x Overall Diameter

ELECTRICAL PROPERTIES

Dielectric test	1000 V r.m.s. for 5' (core-core)
	1000 V r.m.s. for 5' (core-screen)
Impedance	120Ω
Capacitance	45 nF/km conductor to conductor
	90 nF/km conductor to shield

CONSTRUCTION PARAMETERS

Multipair RS 485 Overall Screened Databus Cable

RE-02Y(St)H / RE-02YS(St)H

No. of Pair	Nominal Cross Sectional Area	No./Nominal Diameter of Strands	Nominal Insulation Thickness	Nominal Sheath Thickness	Approx. Overall Diameter	Approx. Weight
No.	mm ²	No/mm	mm	mm	mm	kg/km
1	0.22	7/0.2	0.7	1.1	5.7	45
2	0.22	7/0.2	0.7	1.1	9.0	80
4	0.22	7/0.2	0.7	1.1	10.3	112
1	0.50	16/0.2	0.7	1.1	6.2	57
2	0.50	16/0.2	0.7	1.1	10.1	103
4	0.50	16/0.2	0.7	1.1	11.7	153
1	0.75	24/0.2	0.7	1.1	6.7	66
2	0.75	24/0.2	0.7	1.1	10.9	123
4	0.75	24/0.2	0.7	1.1	12.7	187
1	1.00	30/0.2	0.7	1.1	6.8	72
2	1.00	30/0.2	0.7	1.1	11.2	131
4	1.00	30/0.2	0.7	1.1	13.0	203

Multipair RS 485 Overall Double Screened Databus Cable

RE-02Y(St)CH / RE-02YS(St)CH

No. of Pair	Nominal Cross Sectional Area	No./Nominal Diameter of Strands	Nominal Insulation Thickness	Nominal Sheath Thickness	Approx. Overall Diameter	Approx. Weight
No.	mm ²	No/mm	mm	mm	mm	kg/km
1	0.22	7/0.2	0.7	1.1	6.2	60
2	0.22	7/0.2	0.7	1.1	9.4	105

No. of Pair	Nominal Cross Sectional Area	No./Nominal Diameter of Strands	Nominal Insulation Thickness	Nominal Sheath Thickness	Approx. Overall Diameter	Approx. Weight
No.	mm ²	No/mm	mm	mm	mm	kg/km
4	0.22	7/0.2	0.7	1.1	10.8	142
1	0.50	16/0.2	0.7	1.1	6.7	74
2	0.50	16/0.2	0.7	1.1	10.6	133
4	0.50	16/0.2	0.7	1.1	12.1	187
1	0.75	24/0.2	0.7	1.1	7.1	85
2	0.75	24/0.2	0.7	1.1	11.4	155
4	0.75	24/0.2	0.7	1.1	13.2	225
1	1.00	30/0.2	0.7	1.1	7.3	91
2	1.00	30/0.2	0.7	1.1	11.7	164
4	1.00	30/0.2	0.7	1.1	13.5	242

Multipair RS 485 Individual & Overall Screened Databus Cable

RE-02Y(St)CH PiMF / RE-02YS(St)CH PiMF

No. of Pair	Nominal Cross Sectional Area	No./Nominal Diameter of Strands	Nominal Insulation Thickness	Nominal Sheath Thickness	Approx. Overall Diameter	Approx. Weight
No.	mm ²	No/mm	mm	mm	mm	kg/km
1	0.22	7/0.2	0.7	1.1	6.4	61
2	0.22	7/0.2	0.7	1.1	10.2	110
4	0.22	7/0.2	0.7	1.1	11.7	149
1	0.50	16/0.2	0.7	1.1	7.0	75
2	0.50	16/0.2	0.7	1.1	11.4	137
4	0.50	16/0.2	0.7	1.1	13.2	195
1	0.75	24/0.2	0.7	1.1	7.5	86
2	0.75	24/0.2	0.7	1.1	12.3	160
4	0.75	24/0.2	0.7	1.1	14.3	233
1	1.00	30/0.2	0.7	1.1	7.6	92
2	1.00	30/0.2	0.7	1.1	12.6	169
4	1.00	30/0.2	0.7	1.1	14.7	251



Caledonian

FIRETOX LSZH Flame Retardant Instrumentation & Data Cables

www.caledonian-cables.co.uk www.addison-cables.com

Multipair RS 485 Overall Screened Databus Cable

RE-02YCH / RE-02YSCH

No. of Pair	Nominal Cross Sectional Area	No./Nominal Diameter of Strands	Nominal Insulation Thickness	Nominal Sheath Thickness	Approx. Overall Diameter	Approx. Weight
No.	mm ²	No/mm	mm	mm	mm	kg/km
1	0.22	7/0.2	0.7	1.1	6.0	56
2	0.22	7/0.2	0.7	1.1	9.2	99
4	0.22	7/0.2	0.7	1.1	10.6	134
1	0.50	16/0.2	0.7	1.1	6.5	69
2	0.50	16/0.2	0.7	1.1	10.4	125
4	0.50	16/0.2	0.7	1.1	12.0	179
1	0.75	24/0.2	0.7	1.1	6.9	80
2	0.75	24/0.2	0.7	1.1	11.2	147
4	0.75	24/0.2	0.7	1.1	13.0	216
1	1.00	30/0.2	0.7	1.1	7.1	86
2	1.00	30/0.2	0.7	1.1	11.5	156
4	1.00	30/0.2	0.7	1.1	13.3	233



Rated Voltage



Standard



Flame Retardancy
BS EN 60332-1-2



Reduced Fire Propagation
EN 60332-3-24

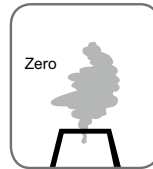

Halogen Free
IEC 60754-1



Low Corrosivity
IEC 60754-2



Low Smoke Emission
IEC 61034-2

TYPE CODES FOR INSTRUMENTATION CABLES

RE-2X(St)H-SWA-H

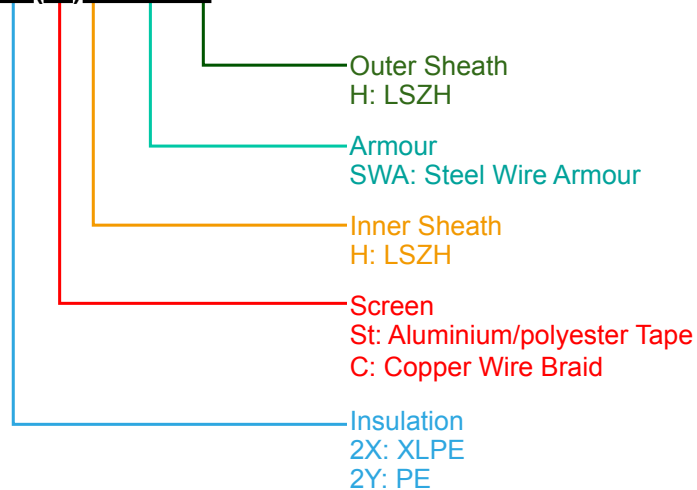

TYPE CODES FOR RS485 DATABUS CABLES

RE-A-B-D

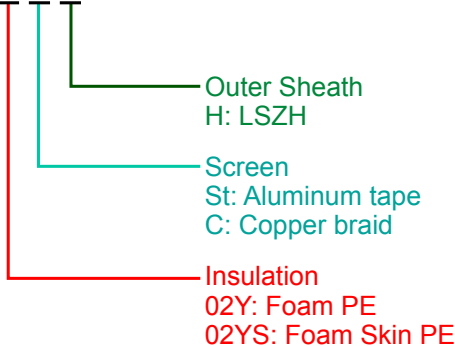

EN 50288-7 COLOUR CODE

Unless otherwise specified e.g. by means of numbered cores or tapes, the coding for identification shall be given in IEC 60189-2 or EN 60708, as appropriate. The colours shall meet the requirements of 4.4 of EN 50288-1.

Coloured or numbered non-hygroscopic binder tapes may be applied over screened cabling elements as identification.

4.4 of EN 50288-1:

When required, the insulated conductors shall be identified by colours and/or additional ring markings and/or symbols achieved by the use of coloured insulation or by a coloured surface using extrusion, printing or painting. Colours shall be clearly identifiable and shall correspond reasonably with the standard colours shown in HD 402.

The colour(s) or the symbol used for core identification shall be durable such that it cannot be removed when tested to EN 50289-3-8.



Caledonian

FIRETOX LSZH Flame Retardant Instrumentation & Data Cables

www.caledonian-cables.co.uk www.addison-cables.com

Technical Information for Fire Properties

FLAME RETARDANCE IN ACCORDANCE WITH DIFFERENT STANDARDS

The following standards specify a method for flame propagation test for single core cables. The single cable sample undergoes the flame action of a bunsen burner. The test only lasts few minutes.

The IEC 60332-1 standards are taken over as EN standards and transferred to national standards Example: IEC 60332-1 becomes EN 60332-1 and introduced in Germany as DIN EN 60332-1.

Flame retardance in accordance with EN 60332:2004

EN 60332:2004 Tests on electrical and optical cables under fire conditions. The standard applies to single insulated wires (cables) and requires a vertical flame test with a maximum flame climb of 450mm. The test lasts between 1 and 8 minutes, depending on the cable diameter.

EN 60332-1-1:2004 / BS EN 60332-1-1:2004 / IEC 60332-1-1:2004 / DIN EN 60332-1-1:2004 / VDE 0482-1-1:2005-06 Test on electrical and optical cables under fire conditions. Test for a vertical flame propagation for a single insulated wire or cables.

EN 60332-1-2:2004 / BS EN 60332-1-2:2004 / IEC 60332-1-2:2004 / DIN EN 60332-1-2:2004 / VDE 0482-1-2:2005-06 / CEI 60332-1-2 (CEI 20-35/1-2) Tests on electrical and optical fiber cables under fire conditions. Test for a

vertical flame propagation for a single insulated wire or cable – Procedure for 1kW premixed flame.



This standard specifies a method of test for resistance to vertical flame propagation for a single insulated wire or cable. Part 1-1 specifies the test apparatus and Part 1-2 specifies the test procedure.

The cable sample is deemed to pass the test if the distance between the lower edge of the top support and the onset of charring is greater than 50mm. In addition, a failure shall be recorded if burning extends downward to a point greater than 540mm from the lower edge of the top support.

EN 60332-1-2:2004 specifies the use of 1kW premix flame and is for general use, except that the procedure may not be suitable for the testing of small insulated conductors or cables of less than 0.5mm sq cross section because the conductor melts before the test is completed, or for the testing of small optic fiber cables because the fiber will be broken before the test is completed. In this case, the procedure given by EN 60332-2-1/2 is recommended.

EN 60332-2-1:2004 / BS EN 60332-2-1:2004 / IEC 60332-2-1:2004 / DIN EN 60332-2-1:2004 / VDE 0482-2-1:2005-06 Tests on electrical and optical cables under fire conditions. Test for a vertical flame propagation for a single small insulated wire or cable.

EN 60332-2-2:2004 / BS EN 60332-2-2:2004 / IEC60332-2-2:2004 / DIN EN 60332-2-2:2004 / VDE 0482-2-2:2005-06 / CEI 60332-2-2 (CEI 20-35/2-2) Test on electric and optical fiber cables under fire conditions. Tests for vertical flame propagation for a single small insulated wire or cable. Procedure for diffusion flame. This test applies to small dimensions cables.

This standard specifies a method of test for resistance to vertical flame propagation for a single insulated wire or cable. Part 2-1 specifies the test apparatus and Part 2-2 specifies the test procedure.

Flame retardance in accordance with NF C32-070-2.1 (C2)

NF C32-070:2001 Insulated conductors and cables for installation - Classification tests on conductors and cables with regard to fire behavior.

NF C32-070 2.1 Procedure for 1 kW pre-mixed flame.

The NF F 32070 2.1 (Category C2) and IEC 60332-1-2 are very similar. The sole difference is the time during which the flame is applied.

Flame retardance in accordance with EN 50265-1:1999 (replaced by EN 60332)

EN 50265-1:1999 / BS EN 50265-1:1999 / DIN EN 50265-1:1999 / VDE 0482-265-1:1999-04 – Common test methods for cables under fire conditions. Test for resistance to a vertical flame propagation for a single insulated conductor or cable. Apparatus (Replaced by EN 60332-1-1:2004 and EN 60332-2-1:2004).

EN 50265-2-1:1999 / BS EN 50265-2-1:1999 / DIN EN 50265-2-1:1999 / VDE 0482-265-2-1:1999-04 – Common test methods for cables under fire conditions. Test for resistance to a vertical flame propagation for a single insulated conductor or cable. Part 2-1: Procedure 1kW pre-mixed flame (Replaced by EN 60332-1-2:2004).

EN 50265-2-2:1999 / BS EN 50265-2-2:1999 / DIN EN 50265-2-2:1999 / VDE 0482-265-2-2:1999-04 – Common test methods for cables under fire conditions. Test for resistance to a vertical flame propagation for a single insulated conductor or cable. Part 2-2: Procedure Diffusion flame (Replaced by EN 60332-2-2:2004).

Flame retardance in accordance with BS 4066 Part 1 & 2 (replaced by EN 60332)

BS 4066-2:1980 (superseded) – Tests on electric cables under fire conditions. Method of test on a single vertical insulated wire or cable.



Caledonian

FIRETOX LSZH Flame Retardant Instrumentation & Data Cables

www.caledonian-cables.co.uk www.addison-cables.com

This standard is no longer in force and is replaced by BS EN 50265-2-1 which was also superseded by BS EN 60332-1:2009.

Flame retardance in accordance with NBN C 30-004 (cat. F1)

NBN C 32-004 specifies a method of test for measuring the vertical flame propagation characteristics of a single wire or cable. The cable specimen is deemed to have passed the test and categorized as F1 if after burning has ceased, the charred or affected portion does not reach within 50mm of the lower edge of the top clamp which is equivalent to 425mm above the point of flame application.

Flame retardance in accordance with IEEE 383

In the IEEE 383 test, cables are supported by a one foot wide vertical rack eight feet high. The cables are positioned in the centre six inches of the rack, spaced one-half diameter apart. The rack is centered in an eight foot enclosure. A ten inch ribbon burner ignites the cable with a 21 kW (70000 BTU). The burner is positioned 2 feet above the floor and 9 to 12 inches of cables are exposed to direct flames for 20 minutes. Cables on which flame extends above the top of the 8 foot rack fail the test.

REDUCED FIRE PROPAGATION IN ACCORDANCE WITH DIFFERENT STANDARDS

These standards specify a method for fire propagation test for vertically mounted bunched cables. These tests simulate the chimney effect in vertical installation of bunch of cables. A certain number of cable sections with a length of 3.5 m is fastened to a vertical ladder in an adapted chamber. The amount of combustible materials for cables and duration of flame application depends on the category the cable has to meet.

Resistance of the wires bundle arranged vertically to the spread of the flame should be such that after a certain time and stopping the source of ignition, flame is extinguished by itself and the length of charred fragments will not exceed 2.5 m in height measured above the lower edge of the burner.



Reduced fire propagation in accordance with IEC 60332-3

This test is the most common one to verify the behaviour of a cables for the fire propagation. The cables are installed on a bunch of vertical ladder inside a metal cabinet and undergo the action of a ribbon flame at 750°C. The standard is subdivided in several parts that differ one from the other for the quantity of cable to be installed, the installation mode and the flame application time.

EN 60332-3-10:2009 / BS EN 60332-3-10:2009 / IEC 60332-3-10 ed1.1 / DIN EN 60332-3-10:2009 / VDE

0482-332-3-10:2010-08 – Common test methods for cables under fire conditions. Tests on electric and optical fiber cables under fire conditions - Part 3-10: Test for vertical flame spread of vertically mounted bunched wires or cables.

EN 60332-3-21:2009 / BS EN 60332-3-21:2009 / IEC 60332-3-21 ed1.1 / DIN EN 60332-3-21 / VDE 0482-332-3-21:2010-08 / CEI EN 60332-3-21:2009 (CEI 20-22/3-1)– Procedures. Tests on electric and optical fiber cables under fire conditions - Part 3-21: Test for vertical flame spread of vertically-mounted bunched wires or cables - Category A . F/R

-Installation In one layer (front).

-Installation In two layers (front and rear)

-The quantity of the Installed cable is equal to 7 litres/m of combustible materials for cables

-The time of application of the flame is 40 minutes

EN 60332-3-22:2009 / BS EN 60332-3-22:2009 / IEC 60332-3-22 ed1.1 / DIN EN 60332-3-22:2009 /VDE 0482-332-3-22:2010-08 / CEI EN 60332-3-22:2009 (CEI 20-22/3-2)– Procedures. Tests on electric and optical fiber cables under fire conditions - Part 3-22: Test for vertical flame spread of vertically-mounted bunched wires or cable - Category A

-Installation In one layer (front).

-The quantity of the installed cable is equal to 7 litres/m of combustible materials for cables

-The time of application of the flame is 40 minutes

EN 60332-3-23:2009 / BS EN 60332-3-23:2009 / IEC 60332-3-23 ed1.1 / DIN EN 60332-3-23:2009 / VDE 0482-332-3-23:2010-08 / CEI EN 60332-3-23:2009 (CEI 20-22/3-3)– Procedures. Tests on electric and optical fiber cables under fire conditions - Part 3-23: Test for vertical flame spread of vertically-mounted bunched wires or cables - Category B

-Installation In one layer (front).

-The quantity of the installed cable is equal to 3.5 litres/m of combustible materials for cables

-The time of application of the flame is 40 minutes

EN 60332-3-24:2009 / BS EN 60332-3-24:2009 / IEC 60332-3-24 ed1.1 / DIN EN 60332-3-24:2009 / VDE 0482-332-3-24:2010-08 / CEI EN 60332-3-24:2009 (CEI 20-22/3-4) – Procedures. Tests on electric and optical fiber cables under fire conditions - Part 3-24: Test for vertical flame spread of vertically-mounted



Test conditions	Wind speed: <8 m/s; Temperature: 5°C - +40°C
Extent of the charred portion	≤2.5m above the bottom edge of the burner, neither at the front nor at the rear of the ladder.

Reduced fire propagation in accordance with NF C32-070-2.2 (C1)

NF C32-070 :2001 Insulated conductors and cables for installation.

-Classification tests on conductors and cables with regard to fire behavior.

A 1600mm vertically installed bundled of cable is exposed to the effects of a radiating oven (approx 830°C) and forced ventilation. Pilot flames arranged above the oven burn off the emitted gases. The test duration is 30 minutes, with the ventilation stopped for every 10 minutes during the flame application period. The cable sample is classified under Category C1 according to NF F 32070-2.2 if the carbonised part of the cable sample does not extend more than 0.8m above the upper base of the oven.

Depending on the damaged length, they can be further classified into 4 classes A, B, C and D according to NF F 16-101 as follows:

Category	Test Result
A	No damaged length from top of the oven in upper position.
B	Damaged length from top of oven in upper position not extending more than 50mm.
C	Damaged length from top of oven in upper position not extending more than 300mm.
D	Damaged length from top of oven in upper position not extending above the top of the chimney.

Reduced fire propagation in accordance to EN 50266-1, EN 50266-2-2, EN 50266-2-3, EN 50266-2-4.

EN 50266-1:2001 / BS EN 50266-1:2001 / DIN EN 50266-1:2001 / VDE 0482-266-1:2001-09– Common test methods for cables under fire conditions. Test for vertical flame spread of vertically mounted bunched wires or cables - Part 1: Apparatus (Replaced by EN 60332-3-10:2009).

EN 50266-2-1:2001 / BS EN 50266-2-1:2001 / DIN EN 50266-2-1:2001 / VDE 0482-266-2-1:2001-09 / CEI EN 50266-2-1– Common test methods for cables under fire conditions. Test for vertical flame spread of vertically mounted bunched wires or cables - Part 2-1 : Procedures. Category A F/R (Replaced by EN 60332-3-21:2009).

EN 50266-2-2:2001 / BS EN 50266-2-2:2001 / DIN EN 50266-2-2:2001 / VDE 0482-266-2-2:2001-09 / CEI EN 50266-2-2– Common test methods for cables under fire conditions. Test for vertical flame spread of vertically mounted bunched wires or cables - Part 2-2: Procedures. Category A (Replaced by EN 60332-3-22:2009).

EN 50266-2-3:2001 / BS EN 50266-2-3:2001 / DIN EN 50266-2-3:2001 / VDE 0482-266-





Caledonian

FIRETOX LSZH Flame Retardant Instrumentation & Data Cables

www.caledonian-cables.co.uk www.addison-cables.com

2-3:2001-09 / CEI EN 50266-2-1 – Common test methods for cables under fire conditions. Test for vertical flame spread of vertically mounted bunched wires or cables

- Part 2-3: Procedures. Category B (Replaced by EN 60332-3-23:2009).

EN 50266-2-4:2001 / BS EN 50266-2-4:2001 / DIN EN 50266-2-4:2001 / VDE 0482-266-2-4:2001-09 / CEI EN 50266-2-4:2001 – Common test methods for cables under fire conditions. Test for vertical flame spread of vertically mounted bunched wires or cables - Part 2-4: Procedures. Category C (Replaced by EN 60332-3-24:2009).

Reduced fire propagation in accordance with BS 4066-3

BS 4066-3:1994 (superseded) – Tests on electric cables under fire conditions. Tests on bunched wires or cables.

This standard is no longer in force and is replaced by the BS EN 50266-1:2001.

Reduced fire propagation in accordance with NBN C 32-004 (F2)

NBN C 32-004 specifies a method of test for measuring the vertical flame propagation characteristics of a bunch of cables. The cable specimen is deemed to have passed the test and categorized as F2 if after burning has ceased, the extent of charred or affected portion does not reach a height exceeding 2.5m above the bottom edge of the burner.

HALOGEN CONTENT TEST IN ACCORDANCE With DIFFERENT STANDARDS

In the event of a fire, many fumes are produced. This test is concerned with the possibilities of corrosive acid gases being released from halogen containing cables and the damage such cables can cause (to equipments). These standards specify a method for determination of the amount of halogen acid gas, evolved during combustion of compound.



Halogen content test in accordance with EN 50267-2-1

EN 50267-2-1:1998 / BS EN 50267-2-1:1999 / DIN EN 50267-2-1: 1999 / VDE 0482-267-2-1:1999-04 / CEI EN 50267-2-1:1999 (CEI 20-37/2-1) Common test methods for cables under fire conditions- Test on gases evolved during combustion of materials from cables- Part 2-1: Procedures. Determination of the amount of halogen acid gas. This part of the standard defines the method to measure the amount of halogen acid evolved and which should be expressed in hydrochloric acid. The amount of halogen acid contained in the test solution is determined by a titration method.

If the cables are described as zero halogen or halogen free, it is recommended that the hydrochloric acid yield should be less than 0.5%.

Halogen content test in accordance with IEC 60754-1

IEC 60754-1 ed 2.0 Common test methods for cables under fire conditions. Test on gases evolved during combustion of materials from cables. Part 1: Procedures. Determination of the amount of halogen acid gas. Basically, this is same as EN 50267-2-1.

Halogen content test in accordance with BS 6425-1

BS 6425-1:1990 (superseded): Test on gases evolved during the combustion of materials from cables. Method for determination of amount of halogen acid gas evolved during combustion of polymeric materials taken from cables.

This standard is no longer in force and is replaced by the EN 50267-2-1.

ACID GAS EMISSION TEST IN ACCORDANCE WITH DIFFERENT STANDARDS

The following standards specify a method for determination of acidity of gas evolved during combustion of cables by measuring PH and conductivity. This test allows to determine the corrosivity of the acid gases generally halogens, that develop during the electric cable combustion.

Acid gas emission test in accordance with EN 50267-2-2

EN 50267-2-2:1999 / BS EN 50267-2-2:1999 / DIN EN 50267-2-2:1999 / VDE 0482-267-2-2:1999- 04/ CEI EN 50267-2-2:1999 (CEI 20-37/2-2). Common test methods for cables under fire conditions- Test on gases evolved during combustion of materials from cables- Part 2-2: Procedures. Determination of degree of acidity of gases for materials by measuring PH and conductivity.

The standard states that the pH and the conductivity of a test solution should be measured, using calibrated PH and conductivity meters.

If the cables are described as zero halogen or halogen free, it is recommended that at least both of the following requirements should be met for each of the individual materials of a cable:

- The PH value should not be less than 4.3 when related to 1 litre of water
- The conductivity should not be less than 10us/mm when related to 1 litre of water

EN 50267-2-3:1999 / BS EN 50267-2-3:1999 / DIN EN 50267-2-3:1999 / VDE 0482-267-2-3:1999-04 / CEI EN 50267-2-3:1999 (CEI 20-37/2-

3). Common test methods for cables under fire conditions- Test on gases evolved during combustion of materials from cables- Part 2-3:Procedures. Determination of degree of acidity of gases for cables by determination of the weighted average of pH and conductivity.





Caledonian

FIRETOX LSZH Flame Retardant Instrumentation & Data Cables

www.caledonian-cables.co.uk www.addison-cables.com

The standard states that the pH and the conductivity of a test solution should be measured, using calibrated pH and conductivity meters. The results from the different components of the cable are then weighted.

Acid gas emission test in accordance with IEC 60754-2

IEC 60754-2 ed1.0 Test on gases evolved during combustion of electric cables - Part 2 : Determination of degree of acidity of gases evolved during combustion of materials taken from electric cables by measuring pH and conductivity.

Acid gas emission test in accordance with NF C32-074

NF C32-074 Common test methods for cables under fire conditions - Test on gases evolved during combustion of materials from cables. This standard is equivalent to IEC 60754-2.

Acid gas emission test in accordance with BS 6425-2

BS 6425-2:1993 (superseded) test on gases evolved during the combustion of materials from cables. Determination of degree of acidity (corrosivity) of gases by measuring pH and conductivity. This standard is no longer in force and is replaced by the EN 50267-2-2:1999.

Acid gas emission test in accordance with DIN VDE 0472-813 / VDE 0472-813:1994

DIN VDE 0472-813 / VDE 0472-813:1994 Corrosivity of combustion gases. The standards are no longer in force and are replaced by the EN 50267-2-2 & VDE 0482-267-2-2.

SMOKE DENSITY TEST IN ACCORDANCE WITH DIFFERENT STANDARDS

The smoke density measurement taken from a material under fire conditions gives an indication of the visibility through the smoke. This is important as reduced visibility in a real fire situation makes it more difficult to escape from the fire thus increasing the threat to human life from the toxic gas, fumes and heat. The following standards specify the method for measuring the generation of smoke from cables during fire.

Smoke density test in accordance with IEC 61034-1 & IEC 61034-2

IEC 61034-1:2005 / EN 61034-1:2005 / BS EN 61034-1:2005 / DIN EN 61034-1:2006 / VDE 0482-1034-1:2006 Measurement of smoke density of cables burning under defined conditions. Part 1: Test apparatus

IEC 61034-2:2005 / EN 61034-2:2005 / BS EN 61034-2:2005 / DIN EN 61034-2:2006 / VDE 0482-1034-2:2006 / CEI EN 61034-2:2006 (CEI 20-37/3-1) Measurement of smoke density of cables burning under defined conditions.



Part 2: Test procedure and requirements.

The standard specifies a method of measurement of smoke density of cables. Part 1 specifies the test apparatus and Part 2 specifies the test procedure.

The test is usually performed inside a chamber of 3mx3mx3m and the test is sometimes described as 3 metres cube test. The test is performed by monitoring the transmittance reduction of a white light beam, running from one side of the chamber to the other, at a set height, thus monitoring the build up of smoke inside the chamber. The minimum percentage of light transmittance is often used to determine if the cable has passed or failed the test, often a minimum light transmittance of 60% is applied in order to classify a cable as low smoke.

Smoke density test in accordance with NF C32- 073

NF C32 073 Common test methods for cables under fire conditions.

- Measurement of smoke density of cables burning under defined conditions.

This standard is equivalent to IEC 61034-2.

Smoke density test in accordance with BS 7622-1 & BS 7622-2

BS 7622-1:1993 (superseded) – Measurement of smoke density of electric cables burning under defined conditions. Test apparatus.

BS 7622-2:1993 (superseded) – Measurement of smoke density of electric cables burning under defined conditions. Test procedure and requirements.

The standards are no longer in force and were replaced by the EN 50268-1:2000 and EN 50268-2:2000 even though they too were superseded by EN 61034-1:2005 and EN 61034-2:2005.

Smoke density test in accordance with EN 50268-1 & EN 50268-2

EN 50268-1:2000 / BS EN 50268-1:2000 / DIN EN 50268-1:2000 / VDE 0482-268-1:2000 (superseded) – Common test methods for cables under fire conditions. Measurement of smoke density of cable burning under defined conditions. Part 1: Apparatus.

EN 50268-2:2000 / BS EN 50268-2:2000 / DIN EN 50268-2:2000 / VDE 0482-268-2:2000 (superseded) – Common test methods for cables under fire conditions. Measurement of smoke density of cable burning under defined conditions. Part 2: Procedure.

The standards are no longer in force and are replaced by the EN 61034-1:2005 and EN 61034-2:2005. Although these standards have been withdrawn, they are still called upon in some specification documents such as in the London Underground specification 1-085.

Smoke density test in accordance with DIN VDE 0472-816 / VDE 0472-816:1994

DIN VDE 0472-816/VDE 0472-816:1994 Testing of cables, wires and flexible cords. Smoke Density.

The standards are no longer in force and are replaced by the EN 50268-1, VDE 0482-268-1, EN 50268-2 &



Caledonian

FIRETOX LSZH Flame Retardant Instrumentation & Data Cables

www.caledonian-cables.co.uk www.addison-cables.com

VDE 0482-268-2 which are also replaced by the EN 61034-1:2005 and EN 61034-2:2005.

OXYGEN INDEX TEST IN ACCORDANCE WITH DIFFERENT STANDARDS

The oxygen index is defined as the minimum concentration of oxygen, expressed as volume percentage, in a mixture of oxygen and nitrogen that will just support combustion of a material initially at room temperature under specified test conditions.



Oxygen Index test in accordance with ASTM D 2863

ASTM D 2863-10 Measuring the minimum oxygen concentration to support candle-like combustion of plastics (Oxygen Index).

The test is performed in accordance with the procedure specified in ASTM 2863-95 using test piece cut from the outer sheath of the cable. The apparatus holds a small specimen which is clamped vertically in a tube in an atmosphere where the relative concentration of oxygen and nitrogen can be changed. The aim is to test the flammability of the sample with a small pilot flame to find the minimum oxygen concentration required to just sustain combustion of the sample.

Oxygen index test in accordance with ISO 4589-2

ISO 4589-2:1996 Determination of burning behaviour by oxygen index Part 2: Ambient temperature test. Specimens measuring 100mm long by 6mm wide are used for testing. The test is performed in accordance with the procedure specified in the standard.

TEMPERATURE INDEX TEST IN ACCORDANCE WITH DIFFERENT STANDARDS

This is a test for assessing the performance of a material when it is tested in accordance with BS 2782: Part 1: Method 143a and 143b. The oxygen index of a material will drop when the temperature rises. When the temperature rises and the oxygen index drops to 21%, the material will burn automatically. This temperature is defined as temperature index.



For example, the oxygen index of the coal at room temperature is 50% and when the temperature climbs to 150°C, its oxygen index drops to 21% and the coal will burn by itself automatically. The temperature index of the coal is defined as 150°C. In general, the temperature index of fire retardant cable exceeds 250°C.

Temperature index test in accordance with BS 2782

BS 2782: Part 1:1989 Method 143a and 143b Temperature of materials. Determination of flammability. Specimens measuring nominally 100mm long by 6.5mm wide by 3mm thick are used for testing. The specimens are then tested in accordance with the test procedure specified in the standard.

Temperature index test in accordance with ISO 4589-3

ISO 4589-3:1996 Determination of burning behaviour by oxygen index Part 3: Elevated temperature test. Specimens measuring 100mm long by 6mm wide are used for testing. The test is performed in accordance with the procedure specified in the standard.

TOXICITY TEST IN ACCORDANCE WITH DIFFERENT STANDARDS

Toxicity test in accordance with NES 02-713

Measuring a fume from a material exposed to a controlled fire conditions gives an indication of the fumes which may be produced in a real fire situation. A standard method of test for determining the toxicity of materials under fire condition is Defense Standard NES 02-713- Toxicity. This method gives the level of toxicity of the fumes produced from the material under test. During the test, the test specimen is heated via direct flame application at 1150°C.

The flame is applied via a bunsen burner with a flame height of between 100mm and 125mm formed with a methane gas and an external supply of compressed air. The specimen toxicity is determined from accurate pre-analysis weight (4pp) colorimetric tubes and ion chromatography.

The test may determine the following species: Hydrogen Bromide, Hydrochloric Acid, Hydrogen Fluoride, Formaldehyde, Nitrous gases, Carbon Monoxide, Carbon Dioxide, Acrylonitrile, Phenol, Hydrogen Sulphide, Sulphur Dioxide, Hydrocyanic Acid, Ammonia. The concentration in ppm for each gas detected are provided. The toxicity index of the specimens summates the toxic gases, taking into account of their level of danger to humans. The smaller the toxicity index, the better the product. A limit of 5 is often applicable.

Toxicity test in accordance with NF C 20-454

NF C 20-454 base environmental testing procedures. Fire behaviour. Analysis and titration of gases evolved during pyrolysis or combustion of materials used in electrotechnics. Exposure to abnormal heat or fire. Tube furnace method.

The test defined by this standard serves to define the conventional toxicity index (cti) of the gases emitted by the insulating or sleeving materials during combustion at 800°C.



Caledonian

FIRETOX LSZH Flame Retardant Instrumentation & Data Cables

www.caledonian-cables.co.uk www.addison-cables.com

Toxicity test in accordance with NF X 70-100

NF X 70-100 Fire Tests; Analysis of gaseous effluents.

The test is conducted within a tube furnace where the temperature is set at either 400°C, 600°C, 800°C (commonly 600°C is used for most of the materials or 800°C for some electrical products) for 40 minutes throughout the test by analysis of the toxicity index of the gases including CO, CO₂, HCl, HBr, HCN, HF and SO₂.





www.caledonian-cables.co.uk
sales@caledonian-cables.co.uk



www.addison-cables.com
sales@addison-cables.com