



**Caledonian**

## **Caledonian Offshore & Marine Cables**



### **IEC60092 STANDARD**

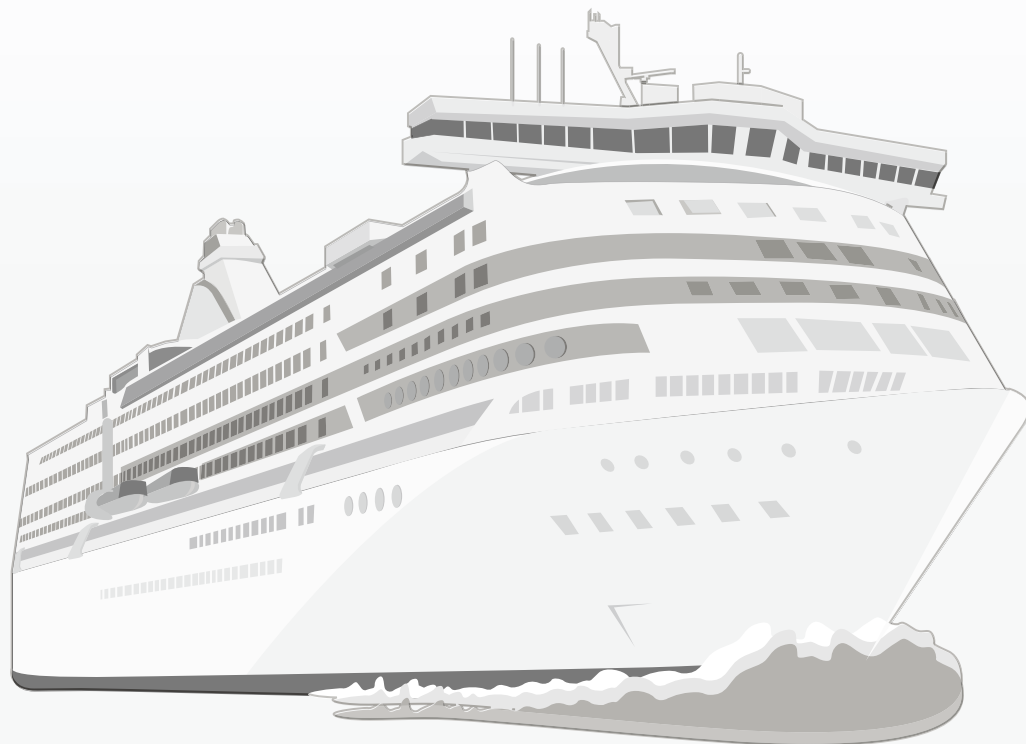

 **ADDISON**

[www.caledonian-cables.co.uk](http://www.caledonian-cables.co.uk)

[www.addison-cables.com](http://www.addison-cables.com)

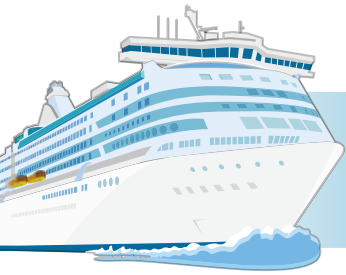

# Company Profile

Caledonian, established in 1978, offers one of the most complete lines of fiber and copper cabling system solutions with over hundreds of different cabling system products. Our superior products provide leading edge within every cable series and for every application.

Among the national and international standards with which our cables could comply are: BS - British Standard; LPCB Fire Performance Standard, ISO Standard etc. Caledonian Cables offers a comprehensive stock of cables and cabling products through its nationwide network of resellers and distributors. Caledonian Cables has continually expanded its global presence in Europe and Asia.

Caledonian & Addison, produces a wide range of cables for communication, power and electronics in its primary plants in UK, Italy and Spain. To stay in front, we continually keep expanding our manufacturing capabilities in more low cost region such as Romania, Taiwan, Malaysia etc. This low-cost manufacturing facilities enable us provide a flexible, scalable global system that delivers superior operational performance and optimal results for our customers.

Our extensive global network of manufacturing facilities gives us significant scale and the flexibility to fulfill our customer requirements. This global presence provides design and consultancy solutions that are combined with core cable manufacturing, logistic services, and vertically integrated with our E commerce technologies, to optimize customer operations by lowering costs and reducing time to market.

Caledonian & Addison has been respected for its high standards of quality, excellent service level, competitive pricing and a unique and innovative spirit. With our latest technologies, we are both inspired and well-positioned to meet the changing needs of our customers. We have the resources to diversify and to enhance our product lines and services. We understand the need for change and with our accurate planning, we are ready for the future and the promise of new marketing opportunities. Our tradition of growth through excellence is assured.

Our Design Centers work closely with customers to constantly improve its standard range of products and technologies and to develop customized, country and industry-specific solutions. Caledonian & Addison has established an extensive network of design, manufacturing, and logistics facilities in the world's major markets to serve the growing outsourcing needs of both multinational and regional customers.



# CONTENT

## MariTox Marine Flame Retardant Medium Voltage Cables

TFOI/TFOU (MTX) 3.6/6kV, 6/10kV, 8.7/15kV XLPE Insulated, LSOH (SHF1) Sheathed, Armoured Flame Retardant MV Power Cables (Halogen Free Inner Covering) .....	5
TIOI/TIOU (MTX) 3.6/6kV, 6/10kV, 8.7/15kV XLPE Insulated, LSOH (SHF1) Sheathed, Armoured Flame Retardant MV Power Cables (SHF1 Inner Sheath) .....	8

## MariTox Marine Flame Retardant Power & Control Cables

TI/TU (MTX300) 0.6/1 kV XLPE Insulated, LSOH (SHF1) Sheathed Flame Retardant Power & Control Cables (Single Core) .....	11
TI /TU (MTX400) 0.6/1 kV XLPE Insulated, LSOH (SHF1) Sheathed Flame Retardant Power & Control Cables (Multicore) .....	13
TOI /TOU (MTX300) 0.6/1 kV XLPE Insulated, LSOH (SHF1) Sheathed, Armoured Flame Retardant Power & Control Cables (Single Core) .....	16
TFOI/TFOU (MTX400) 0.6/1 kV XLPE Insulated, LSOH (SHF1) Sheathed, Armoured Flame Retardant Power & Control Cables (Multicore) .....	18
RI / RU (MTX300) 0.6/1 kV HEPR Insulated, LSOH (SHF1) Sheathed Flame Retardant Power & Control Cables (Single Core) .....	21
RI/RU (MTX400) 0.6/1 kV HEPR Insulated, LSOH (SHF1) Sheathed Flame Retardant Power & Control Cables (Multicore) .....	23
ROI/ROU (MTX300) 0.6/1 kV HEPR Insulated, LSOH (SHF1) Sheathed, Screened Flame Retardant Power & Control Cables (Single Core) .....	25
RFOI /RFOU (MTX400) 0.6/1 kV HEPR Insulated, LSOH (SHF1) Sheathed, Screened Flame Retardant Power & Control Cables (Multicore) .....	27

## MariFlex Marine Fire Resistant Power & Control Cables

BI/BU (MFX300) 0.6/1 kV Mica Tape + XLPE Insulated, LSOH (SHF1) Sheathed Fire Resistant Power & Control Cables (Single Core) .....	30
BI/BU (MFX400) 0.6/1 kV Mica Tape + XLPE Insulated, LSOH (SHF1) Sheathed Fire Resistant Power & Control Cables (Multicore) .....	32
BOI/BOU (MFX300) 0.6/1 kV Mica Tape + XLPE Insulated, LSOH (SHF1) Sheathed, Armoured Fire Resistant Power & Control Cables (Single Core) .....	35



BFOI/BFOU (MFX400) 0.6/1 kV Mica Tape + XLPE Insulated, LSOH (SHF1) Sheathed, Armoured Fire Resistant Power & Control Cables (Multicore) ..... 37

BOI/BOU (MFX300) 0.6/1 kV Fire Barriers + HEPR Insulated, LSOH (SHF1) Sheathed, Screened Fire Resistant Power & Control Cables (Single Core) ..... 40

BFOI (c)/ BFOU (c) (MFX400) 0.6/1 kV Fire Barriers + HEPR Insulated, LSOH (SHF1) Sheathed, Screened Fire Resistant Power & Control Cables (Multicore) ..... 42

### MariSig Flame Retardant Instrumentation & Control Cables

TI/ TU (MRE-2XH) 150/250V XLPE Insulated, LSOH (SHF1) Sheathed Flame Retardant Instrumentation & Control Cables (Multicore)..... 44

TIOI/ TIOU (MRE-2XCH) 150/250V XLPE Insulated, LSOH (SHF1) Sheathed, Armoured Flame Retardant Instrumentation & Control Cables (Multicore) ..... 46

TFOI/ TFOU (MRE-2XCH) 150/250V XLPE Insulated, LSOH (SHF1) Sheathed, Armoured Flame Retardant Instrumentation & Control Cables (Multipair/Multitrip)..... 48

TIOI (c)/ TIOU(c) (MRE-2X(St)HCH)150/250V XLPE Insulated, LSOH (SHF1) Sheathed, Overall Screened & Armoured Flame Retardant Instrumentation & Control Cables (Multipair/Multitrip) .... 52

TI (c)/ TU(c) (MRE-2X(St)H)150/250V XLPE Insulated, LSOH (SHF1) Sheathed, Overall Screened Flame Retardant Instrumentation & Control Cables (Multipair/Multitrip)..... 56

TI (i)/ TU(i) (MRE-2XH PiMF/TiMF) 150/250V XLPE Insulated, LSOH (SHF1) Sheathed, Individual Screened Flame Retardant Instrumentation & Control Cables (Multipair/Multitrip) ..... 60

TFOI (i) /TFOU (i) (MRE-2XCH PiMF/TiMF) 150/250V XLPE Insulated, LSOH (SHF1) Sheathed, Individual Screened & Armoured Flame Retardant Instrumentation & Control Cables (Multipair/ Multitrip) ..... 63

ROI/ ROU (MRE-3GCH) 150/250V HEPR Insulated, LSOH (SHF1) Sheathed, Armoured Flame Retardant Instrumentation & Control Cables (Multipair)..... 67

### MariSig Fire Resistant Instrumentation & Control Cables

BI/ BU (MRE-M2XH) 150/250V Mica Tape + XLPE Insulated, LSOH (SHF1) Sheathed Fire Resistant Instrumentation & Control Cables (Multicore)..... 69

BFOI (c)/BFOU (c) (MRE-M2X(St)CH) 150/250V Mica Tape + XLPE Insulated, LSOH (SHF1) Sheathed, Overall Screened & Armoured Fire Resistant Instrumentation & Control Cables (Multipair/ Multitrip) ..... 71

BI (c)/ BU(c) (MRE-M2X(St)H) 150/250V Mica Tape + XLPE Insulated, LSOH (SHF1) Sheathed, Overall Screened Fire Resistant Instrumentation & Control Cables (Multipair/Multitrip) ..... 75



## Content

[www.caledonian-cables.co.uk](http://www.caledonian-cables.co.uk)

BI (i)/ BU(i) (MRE-M2XH PiMF/TiMF) 150/250V Mica Tape + XLPE Insulated, LSOH (SHF1) Sheathed, Individual Screened Fire Resistant Instrumentation & Control Cables (Multipair/Multitrip) .....	79
BFOI/ BFOU (MRE-M2XCH) 150/250V Mica Tape + XLPE Insulated, LSOH (SHF1) Sheathed, Armoured Fire Resistant Instrumentation & Control Cables (Multipair/Multitrip) .....	82
BFOI (i)/ BFOU (i) (MRE-M2XCH PiMF/TiMF) 150/250V Mica Tape + XLPE Insulated, LSOH (SHF1) Sheathed, Individual Screened & Armoured Fire Resistant Instrumentation & Control Cables (Multipair/Multitrip) .....	86
BOI/ BOU (MRE-M3GCH) 150/250V Mica Tape + HEPR Insulated, LSOH (SHF1) Sheathed, Armoured Fire Resistant Instrumentation & Control Cables (Multipair).....	90

## MariLan Marine Lan Data & Communication Cables

Cat 5e S/FTP 0.22mm <sup>2</sup> .....	92
Mud Resistant Cat 5e S/FTP 0.22mm <sup>2</sup> .....	94
Cat 5e SF/UTP 24AWG 4P/8P .....	96
Armoured Cat 5e SF/UTP 24AWG .....	98
Cat 5e F/UTP 24AWG .....	100
Cat 6 U/FTP 23AWG .....	102
Armoured Cat 6 S/FTP 23AWG .....	104
Cat 6 SF/UTP 24AWG 4P/8P .....	106
Cat 7 S/FTP 0.27 mm <sup>2</sup> .....	108
Mud Resistant Cat 7 S/FTP 0.27 mm <sup>2</sup> .....	110
Cat 7 S/FTP 23AWG 4P/8P .....	112
RG Series Coaxial Cables 50 Ω /75 Ω .....	115
KX Series Coaxial Cables 50 Ω /75 Ω .....	117
PROFIBUS 1 Pair 22 AWG .....	119
Armoured PROFIBUS 1 Pair 22 AWG .....	121



PROFIBUS 1 Pair 0.35mm <sup>2</sup> .....	123
CAN BUS CABLES 120 Ω .....	125
Breakout Fiber Cable .....	127
Indoor Optical Fiber Cables with Central Strength .....	129
Tight Buffer Optical Fiber Cables .....	131
Central Loose Tube Optical Fiber Cables .....	133
Fire Resistant Central Loose Tube Optical Fiber Cables .....	135

### Technical Information

Caledonian Order Code .....	137
Power Copper Conductors According to IEC 60228 .....	141
Instrumentation & Control Conductors According to IEC 60092-376 .....	142
Current Ratings for Continuous Service (IEC 60092-352) .....	143
Short Circuit Current Ratings .....	144
Reactance / Impedance .....	145
Voltage Drop (Cables Up to 1 KV) .....	146
Voltage Drop Coefficient .....	147



### TFOI/TFOU (MTX)

### 3.6/6kV, 6/10kV, 8.7/15kV XLPE Insulated, LSOH (SHF1) Sheathed, Armoured Flame Retardant MV Power Cables (Halogen Free Inner Covering)

#### Application

These armoured MV cables are used on board of ships in all locations for fixed installations complying with IEC standards 60092-352. These cables are flame retardant, low smoke & halogen free.

#### Standards

- IEC 60092-350/354/360
- IEC 60332-1
- IEC 60332-3-22
- IEC 60754-1/2
- IEC 61034

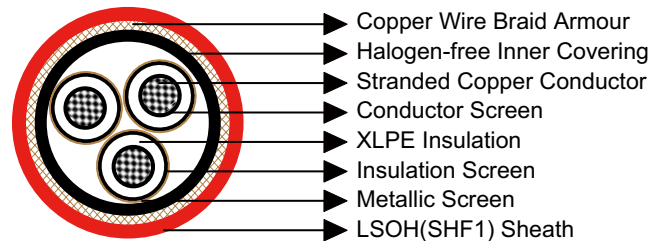

#### Construction

- Conductors: Class 2 stranded copper conductor.
- Conductor Screen: Semi-conducting layer (tape/compound).
- Insulation: XLPE.
- Insulation Screen: Semi-conducting layer (tape/compound).
- Metallic Screen: Copper tape.
- Inner Covering: Halogen free compound.
- Armour: Copper wire braid.
- Outer Sheath: LSOH (SHF1). SHF2 can be offered upon request.

#### Core Identification

Coloured tape shall be inserted under metallic screen.  
3core: Red, Yellow, Blue.



# IEC Standard Caledonian Offshore & Marine Cables

## MariTox Marine Flame Retardant Medium Voltage Cables

www.caledonian-cables.co.uk

### Mechanical and Thermal Properties

Bending Radius for Fixed Installations:  $12 \times OD$  (single core);  $9 \times OD$  (three core)

Temperature Range:  $-30^{\circ}\text{C} \sim +80^{\circ}\text{C}$

### Dimensions and Weight

#### 3.6/6kV

Part No.	Construction No. of cores $\times$ Cross section ( $\text{mm}^2$ )	Nominal Insulation Thickness mm	Nominal Sheath Thickness mm	Nominal Overall Diameter mm	Nominal Weight kg/km
MTX-3.6/6KV-RMZ1-1C10	1 $\times$ 10	2.5	1.5	19.6	580
MTX-3.6/6KV-RMZ1-1C16	1 $\times$ 16	2.5	1.5	20.5	670
MTX-3.6/6KV-RMZ1-1C25	1 $\times$ 25	2.5	1.5	21.8	800
MTX-3.6/6KV-RMZ1-1C35	1 $\times$ 35	2.5	1.6	23.2	940
MTX-3.6/6KV-RMZ1-1C50	1 $\times$ 50	2.5	1.6	24.5	1100
MTX-3.6/6KV-RMZ1-1C70	1 $\times$ 70	2.5	1.7	26.5	1380
MTX-3.6/6KV-RMZ1-1C95	1 $\times$ 95	2.5	1.8	28.6	1700
MTX-3.6/6KV-RMZ1-1C120	1 $\times$ 120	2.5	1.9	30.4	2000
MTX-3.6/6KV-RMZ1-1C150	1 $\times$ 150	2.5	1.9	32.0	2320
MTX-3.6/6KV-RMZ1-1C185	1 $\times$ 185	2.5	2.0	34.4	2770
MTX-3.6/6KV-RMZ1-1C240	1 $\times$ 240	2.6	2.1	38.0	3530
MTX-3.6/6KV-RMZ1-1C300	1 $\times$ 300	2.8	2.3	41.2	4270
MTX-3.6/6KV-RMZ1-1C400	1 $\times$ 400	3.0	2.4	45.6	5410
MTX-3.6/6KV-RMZ1-1C500	1 $\times$ 500	3.2	2.5	48.9	6390
MTX-3.6/6KV-RMZ1-1C630	1 $\times$ 630	3.2	2.7	53.5	8030
MTX-3.6/6KV-RMZ1-3C10	3 $\times$ 10	2.5	2.0	35.4	1620
MTX-3.6/6KV-RMZ1-3C16	3 $\times$ 16	2.5	2.2	38.4	2030
MTX-3.6/6KV-RMZ1-3C25	3 $\times$ 25	2.5	2.3	41.4	2470
MTX-3.6/6KV-RMZ1-3C35	3 $\times$ 35	2.5	2.4	44.2	2930
MTX-3.6/6KV-RMZ1-3C50	3 $\times$ 50	2.5	2.5	47.6	3510
MTX-3.6/6KV-RMZ1-3C70	3 $\times$ 70	2.5	2.7	51.9	4390
MTX-3.6/6KV-RMZ1-3C95	3 $\times$ 95	2.5	2.8	56.6	5470
MTX-3.6/6KV-RMZ1-3C120	3 $\times$ 120	2.5	3.0	60.4	6450
MTX-3.6/6KV-RMZ1-3C150	3 $\times$ 150	2.5	3.1	64.1	7490
MTX-3.6/6KV-RMZ1-3C185	3 $\times$ 185	2.5	3.3	68.3	8850
MTX-3.6/6KV-RMZ1-3C240	3 $\times$ 240	2.6	3.5	75.4	11080

#### 6/10kV

Part No.	Construction No. of cores $\times$ Cross section ( $\text{mm}^2$ )	Nominal Insulation Thickness mm	Nominal Sheath Thickness mm	Nominal Overall Diameter mm	Nominal Weight kg/km
MTX-6/10KV-RMZ1-1C16	1 $\times$ 16	3.4	1.6	22.5	750
MTX-6/10KV-RMZ1-1C25	1 $\times$ 25	3.4	1.6	23.8	890
MTX-6/10KV-RMZ1-1C35	1 $\times$ 35	3.4	1.7	25.2	1040
MTX-6/10KV-RMZ1-1C50	1 $\times$ 50	3.4	1.7	26.5	1200



# IEC Standard Caledonian Offshore & Marine Cables



## MariTox Marine Flame Retardant Medium Voltage Cables

www.caledonian-cables.co.uk

Part No.	Construction No. of cores×Cross section(mm <sup>2</sup> )	Nominal Insulation Thickness mm	Nominal Sheath Thickness mm	Nominal Overall Diameter mm	Nominal Weight kg/km
MTX-6/10KV-RMZ1-1C70	1×70	3.4	1.8	28.5	1480
MTX-6/10KV-RMZ1-1C95	1×95	3.4	1.9	30.6	1810
MTX-6/10KV-RMZ1-1C120	1×120	3.4	1.9	32.2	2100
MTX-6/10KV-RMZ1-1C150	1×150	3.4	2.0	34.4	2470
MTX-6/10KV-RMZ1-1C185	1×185	3.4	2.1	36.9	2980
MTX-6/10KV-RMZ1-1C240	1×240	3.4	2.2	39.8	3650
MTX-6/10KV-RMZ1-1C300	1×300	3.4	2.3	42.4	4340
MTX-6/10KV-RMZ1-1C400	1×400	3.4	2.5	46.6	5480
MTX-6/10KV-RMZ1-1C500	1×500	3.4	2.6	49.5	6430
MTX-6/10KV-RMZ1-1C630	1×630	3.4	2.7	53.9	8040
MTX-6/10KV-RMZ1-3C16	3×16	3.4	2.3	42.5	2330
MTX-6/10KV-RMZ1-3C25	3×25	3.4	2.4	45.9	2840
MTX-6/10KV-RMZ1-3C35	3×35	3.4	2.5	48.7	3310
MTX-6/10KV-RMZ1-3C50	3×50	3.4	2.7	51.9	3890
MTX-6/10KV-RMZ1-3C70	3×70	3.4	2.8	56.4	4820
MTX-6/10KV-RMZ1-3C95	3×95	3.4	3.0	60.8	5900
MTX-6/10KV-RMZ1-3C120	3×120	3.4	3.1	64.5	6880
MTX-6/10KV-RMZ1-3C150	3×150	3.4	3.3	68.3	7960
MTX-6/10KV-RMZ1-3C185	3×185	3.4	3.4	72.8	9390
MTX-6/10KV-RMZ1-3C240	3×240	3.4	3.7	79.2	11570

### 8.7/15kV

Part No.	Construction No. of cores×Cross section(mm <sup>2</sup> )	Nominal Insulation Thickness mm	Nominal Sheath Thickness mm	Nominal Overall Diameter mm	Nominal Weight kg/km
MTX-8.7/15KV-RMZ1-1C25	1×25	4.5	1.7	26.2	1020
MTX-8.7/15KV-RMZ1-1C35	1×35	4.5	1.8	27.6	1170
MTX-8.7/15KV-RMZ1-1C50	1×50	4.5	1.8	28.9	1340
MTX-8.7/15KV-RMZ1-1C70	1×70	4.5	1.9	30.9	1630
MTX-8.7/15KV-RMZ1-1C95	1×95	4.5	2.0	33.4	2000
MTX-8.7/15KV-RMZ1-1C120	1×120	4.5	2.0	35.0	2300
MTX-8.7/15KV-RMZ1-1C150	1×150	4.5	2.1	37.3	2730
MTX-8.7/15KV-RMZ1-1C185	1×185	4.5	2.2	39.3	3180
MTX-8.7/15KV-RMZ1-1C240	1×240	4.5	2.3	42.2	3860
MTX-8.7/15KV-RMZ1-1C300	1×300	4.5	2.4	45.2	4600
MTX-8.7/15KV-RMZ1-1C400	1×400	4.5	2.5	48.8	5690
MTX-8.7/15KV-RMZ1-1C500	1×500	4.5	2.7	51.9	6680
MTX-8.7/15KV-RMZ1-1C630	1×630	4.5	2.8	56.7	8360
MTX-8.7/15KV-RMZ1-3C25	3×25	4.5	2.6	51.0	3280
MTX-8.7/15KV-RMZ1-3C35	3×35	4.5	2.7	53.8	3770
MTX-8.7/15KV-RMZ1-3C50	3×50	4.5	2.9	57.4	4430
MTX-8.7/15KV-RMZ1-3C70	3×70	4.5	3.0	61.5	5340
MTX-8.7/15KV-RMZ1-3C95	3×95	4.5	3.2	66.0	6460
MTX-8.7/15KV-RMZ1-3C120	3×120	4.5	3.3	69.6	7460
MTX-8.7/15KV-RMZ1-3C150	3×150	4.5	3.5	73.9	8640
MTX-8.7/15KV-RMZ1-3C185	3×185	4.5	3.6	78.0	10040
MTX-8.7/15KV-RMZ1-3C240	3×240	4.5	3.9	84.4	12270



### TIOI/TIOU (MTX)

### 3.6/6kV, 6/10kV, 8.7/15kV XLPE Insulated, LSOH (SHF1) Sheathed, Armoured Flame Retardant MV Power Cables (SHF1 Inner Sheath)

### Application

These armoured MV cables are used on board of ships in all locations for fixed installations complying with IEC standards 60092-352. These cables are flame retardant, low smoke & halogen free.

### Standards

- IEC 60092-350/354/360
- IEC 60332-1
- IEC 60332-3-22
- IEC 60754-1/2
- IEC 61034

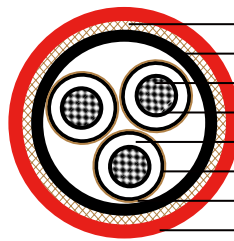

- ▶ Copper/Galvanized Steel Wire Braid Armour
- ▶ LSOH(SHF1) Inner Sheath
- ▶ Stranded Copper Conductor
- ▶ Conductor Screen
- ▶ XLPE Insulation
- ▶ Insulation Screen
- ▶ Metallic Screen
- ▶ LSOH(SHF1) Outer Sheath

### Construction

- Conductors: Class 2 stranded copper conductor.
- Conductor Screen: Semi-conducting layer (tape/compound).
- Insulation: XLPE.
- Insulation Screen: Semi-conducting layer (tape/compound).
- Metallic Screen: Copper tape
- Inner Sheath: LSOH (SHF1).
- Armour: Copper wire braid or galvanized steel wire braid.
- Outer Sheath: LSOH (SHF1). SHF2 can be offered upon request.

### Core Identification

Coloured tape shall be inserted under metallic screen.  
3core: Red, Yellow, Blue.



### Mechanical and Thermal Properties

Bending Radius for Fixed Installations: 12×OD (single core); 9×OD (three core)  
Temperature Range: -30°C ~ +80°C

### Dimensions and Weight

#### 3.6/6kV

Part No.	Construction No. of cores×Cross section(mm <sup>2</sup> )	Nominal Insulation Thickness mm	Nominal Sheath Thickness mm		Nominal Overall Diameter mm	Nominal Weight kg/km
			Inner	Outer		
MTX-3.6/6KV-RZ1MZ1-1C10	1×10	2.5	1.3	1.0	19.2	560
MTX-3.6/6KV-RZ1MZ1-1C16	1×16	2.5	1.3	1.0	20.1	650
MTX-3.6/6KV-RZ1MZ1-1C25	1×25	2.5	1.4	1.1	21.8	800
MTX-3.6/6KV-RZ1MZ1-1C35	1×35	2.5	1.4	1.1	23.0	940
MTX-3.6/6KV-RZ1MZ1-1C50	1×50	2.5	1.5	1.2	24.7	1120
MTX-3.6/6KV-RZ1MZ1-1C70	1×70	2.5	1.6	1.2	26.7	1390
MTX-3.6/6KV-RZ1MZ1-1C95	1×95	2.5	1.6	1.3	28.8	1720
MTX-3.6/6KV-RZ1MZ1-1C120	1×120	2.5	1.7	1.3	30.6	2020
MTX-3.6/6KV-RZ1MZ1-1C150	1×150	2.5	1.8	1.3	32.4	2350
MTX-3.6/6KV-RZ1MZ1-1C185	1×185	2.5	1.8	1.4	34.4	2780
MTX-3.6/6KV-RZ1MZ1-1C240	1×240	2.6	2.0	1.5	38.4	3580
MTX-3.6/6KV-RZ1MZ1-1C300	1×300	2.8	2.1	1.6	41.6	4310
MTX-3.6/6KV-RZ1MZ1-1C400	1×400	3.0	2.2	1.7	45.8	5440
MTX-3.6/6KV-RZ1MZ1-1C500	1×500	3.2	2.4	1.7	49.3	6450
MTX-3.6/6KV-RZ1MZ1-1C630	1×630	3.2	2.5	1.9	54.1	8110
MTX-3.6/6KV-RZ1MZ1-3C10	3×10	2.5	1.9	1.4	36.3	1710
MTX-3.6/6KV-RZ1MZ1-3C16	3×16	2.5	2.0	1.5	38.8	2030
MTX-3.6/6KV-RZ1MZ1-3C25	3×25	2.5	2.1	1.6	42.0	2500
MTX-3.6/6KV-RZ1MZ1-3C35	3×35	2.5	2.2	1.6	44.8	2950
MTX-3.6/6KV-RZ1MZ1-3C50	3×50	2.5	2.3	1.7	48.0	3510
MTX-3.6/6KV-RZ1MZ1-3C70	3×70	2.5	2.5	1.8	52.5	4420
MTX-3.6/6KV-RZ1MZ1-3C95	3×95	2.5	2.6	1.9	57.0	5470
MTX-3.6/6KV-RZ1MZ1-3C120	3×120	2.5	2.8	2.0	61.0	6480
MTX-3.6/6KV-RZ1MZ1-3C150	3×150	2.5	2.9	2.1	64.9	7540
MTX-3.6/6KV-RZ1MZ1-3C185	3×185	2.5	3.1	2.2	69.3	8940
MTX-3.6/6KV-RZ1MZ1-3C240	3×240	2.6	3.3	2.4	76.4	11180

#### 6/10kV

Part No.	Construction No. of cores×Cross section(mm <sup>2</sup> )	Nominal Insulation Thickness mm	Nominal Sheath Thickness mm		Nominal Overall Diameter mm	Nominal Weight kg/km
			Inner	Outer		
MTX-6/10KV-RZ1MZ1-1C16	1×16	3.4	1.4	1.1	22.3	750
MTX-6/10KV-RZ1MZ1-1C25	1×25	3.4	1.5	1.1	23.8	890
MTX-6/10KV-RZ1MZ1-1C35	1×35	3.4	1.5	1.2	25.2	1040
MTX-6/10KV-RZ1MZ1-1C50	1×50	3.4	1.6	1.2	26.7	1220
MTX-6/10KV-RZ1MZ1-1C70	1×70	3.4	1.6	1.2	28.5	1480



# IEC Standard Caledonian Offshore & Marine Cables

## MariTox Marine Flame Retardant Medium Voltage Cables

www.caledonian-cables.co.uk

Part No.	Construction No. of cores×Cross section(mm <sup>2</sup> )	Nominal Insulation Thickness mm	Nominal Sheath Thickness mm		Nominal Overall Diameter mm	Nominal Weight kg/km
			Inner	Outer		
MTX-6/10KV-RZ1MZ1-1C95	1×95	3.4	1.7	1.3	30.8	1830
MTX-6/10KV-RZ1MZ1-1C120	1×120	3.4	1.8	1.3	32.6	2140
MTX-6/10KV-RZ1MZ1-1C150	1×150	3.4	1.8	1.4	34.4	2470
MTX-6/10KV-RZ1MZ1-1C185	1×185	3.4	1.9	1.4	36.9	2990
MTX-6/10KV-RZ1MZ1-1C240	1×240	3.4	2.0	1.5	40.0	3680
MTX-6/10KV-RZ1MZ1-1C300	1×300	3.4	2.1	1.6	42.8	4390
MTX-6/10KV-RZ1MZ1-1C400	1×400	3.4	2.3	1.7	46.8	5510
MTX-6/10KV-RZ1MZ1-1C500	1×500	3.4	2.4	1.8	49.9	6480
MTX-6/10KV-RZ1MZ1-1C630	1×630	3.4	2.5	1.9	54.5	8130
MTX-6/10KV-RZ1MZ1-3C16	3×16	3.4	2.1	1.6	43.1	2350
MTX-6/10KV-RZ1MZ1-3C25	3×25	3.4	2.2	1.7	46.3	2840
MTX-6/10KV-RZ1MZ1-3C35	3×35	3.4	2.3	1.7	49.1	3310
MTX-6/10KV-RZ1MZ1-3C50	3×50	3.4	2.5	1.8	52.5	3910
MTX-6/10KV-RZ1MZ1-3C70	3×70	3.4	2.6	1.9	56.8	4820
MTX-6/10KV-RZ1MZ1-3C95	3×95	3.4	2.8	2.0	61.4	5930
MTX-6/10KV-RZ1MZ1-3C120	3×120	3.4	2.9	2.1	65.3	6940
MTX-6/10KV-RZ1MZ1-3C150	3×150	3.4	3.1	2.2	69.3	8050
MTX-6/10KV-RZ1MZ1-3C185	3×185	3.4	3.2	2.3	73.6	9460
MTX-6/10KV-RZ1MZ1-3C240	3×240	3.4	3.4	2.5	80.2	11680

### 8.7/15kV

Part No.	Construction No. of cores×Cross section(mm <sup>2</sup> )	Nominal Insulation Thickness mm	Nominal Sheath Thickness mm		Nominal Overall Diameter mm	Nominal Weight kg/km
			Inner	Outer		
MTX-8.7/15KV-RZ1MZ1-1C25	1×25	4.5	1.6	1.2	26.4	1030
MTX-8.7/15KV-RZ1MZ1-1C35	1×35	4.5	1.6	1.2	27.6	1180
MTX-8.7/15KV-RZ1MZ1-1C50	1×50	4.5	1.7	1.3	29.3	1370
MTX-8.7/15KV-RZ1MZ1-1C70	1×70	4.5	1.7	1.3	31.1	1650
MTX-8.7/15KV-RZ1MZ1-1C95	1×95	4.5	1.8	1.4	33.4	2010
MTX-8.7/15KV-RZ1MZ1-1C120	1×120	4.5	1.9	1.4	35.7	2410
MTX-8.7/15KV-RZ1MZ1-1C150	1×150	4.5	1.9	1.5	37.5	2760
MTX-8.7/15KV-RZ1MZ1-1C185	1×185	4.5	2.0	1.5	39.5	3200
MTX-8.7/15KV-RZ1MZ1-1C240	1×240	4.5	2.1	1.6	42.6	3910
MTX-8.7/15KV-RZ1MZ1-1C300	1×300	4.5	2.2	1.6	45.2	4610
MTX-8.7/15KV-RZ1MZ1-1C400	1×400	4.5	2.3	1.7	49.0	5730
MTX-8.7/15KV-RZ1MZ1-1C500	1×500	4.5	2.5	1.8	52.3	6740
MTX-8.7/15KV-RZ1MZ1-1C630	1×630	4.5	2.6	1.9	56.9	8400
MTX-8.7/15KV-RZ1MZ1-3C25	3×25	4.5	2.4	1.8	51.6	3300
MTX-8.7/15KV-RZ1MZ1-3C35	3×35	4.5	2.5	1.9	54.6	3820
MTX-8.7/15KV-RZ1MZ1-3C50	3×50	4.5	2.6	1.9	57.6	4400
MTX-8.7/15KV-RZ1MZ1-3C70	3×70	4.5	2.8	2.0	62.1	5370
MTX-8.7/15KV-RZ1MZ1-3C95	3×95	4.5	3.0	2.2	67.0	6550
MTX-8.7/15KV-RZ1MZ1-3C120	3×120	4.5	3.1	2.3	70.8	7580
MTX-8.7/15KV-RZ1MZ1-3C150	3×150	4.5	3.2	2.3	74.5	8680
MTX-8.7/15KV-RZ1MZ1-3C185	3×185	4.5	3.4	2.5	79.2	10180
MTX-8.7/15KV-RZ1MZ1-3C240	3×240	4.5	3.6	2.6	85.6	12420



### TI/TU (MTX300)

## 0.6/1 kV XLPE Insulated, LSOH (SHF1) Sheathed Flame Retardant Power & Control Cables (Single Core)

### Application

These unarmoured power & control cables are used on board of ships in all locations for fixed installations not subject to mechanical risk complying with IEC standards 60092-352. These cables are flame retardant, low smoke & halogen free.

### Standards

- IEC 60092-350/353/360
- IEC 60332-1
- IEC 60332-3-22
- IEC 60754-1/2
- IEC 61034

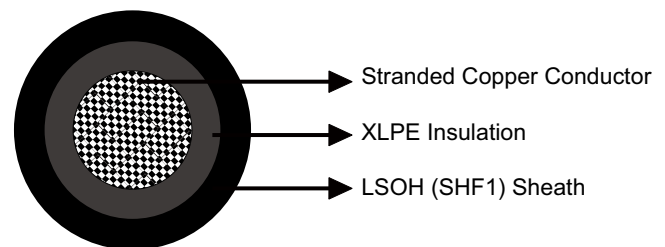

### Construction

- Conductors: Class 2 stranded copper conductor, round or sector shaped. Class 5 stranded conductors can be offered upon request.
- Insulation: XLPE.
- Outer Sheath: LSOH (SHF1). SHF2 can be offered upon request.

### Core Identification

- Single core: Black

### Mechanical and Thermal Properties

Bending Radius for Fixed Installations:  $6 \times OD$  ( $OD > 25\text{mm}$ );  $4 \times OD$  ( $OD \leq 25\text{mm}$ )  
Temperature Range:  $-30^{\circ}\text{C} \sim +80^{\circ}\text{C}$





# IEC Standard Caledonian Offshore & Marine Cables

## MariTox Marine Flame Retardant Power & Control Cables

[www.caledonian-cables.co.uk](http://www.caledonian-cables.co.uk)

### Dimensions and Weight

**MTX300 1RZ1-R Single Core 0.6/1kV (-R stands for class 2 conductor. For class 5 conductor, please change -R to -F)**

Part No.	Construction No. of cores×Cross section(mm <sup>2</sup> )	Nominal Insulation Thickness mm	Nominal Sheath Thickness mm	Nominal Overall Diameter mm	Nominal Weight kg/km
MTX300-1RZ1-R-1C1.5	1×1.5	0.7	1.0	5.0	40
MTX300-1RZ1-R-1C2.5	1×2.5	0.7	1.0	5.4	50
MTX300-1RZ1-R-1C4	1×4	0.7	1.04	6.0	70
MTX300-1RZ1-R-1C6	1×6	0.7	1.04	6.6	90
MTX300-1RZ1-R-1C10	1×10	0.7	1.04	7.5	130
MTX300-1RZ1-R-1C16	1×16	0.7	1.04	8.5	190
MTX300-1RZ1-R-1C25	1×25	0.9	1.1	10.4	295
MTX300-1RZ1-R-1C35	1×35	0.9	1.1	11.7	380
MTX300-1RZ1-R-1C50	1×50	1.0	1.2	13.3	510
MTX300-1RZ1-R-1C70	1×70	1.1	1.3	15.5	720
MTX300-1RZ1-R-1C95	1×95	1.1	1.3	17.4	970
MTX300-1RZ1-R-1C120	1×120	1.2	1.4	19.4	1220
MTX300-1RZ1-R-1C150	1×150	1.4	1.5	21.5	1505
MTX300-1RZ1-R-1C185	1×185	1.6	1.5	23.8	1865
MTX300-1RZ1-R-1C240	1×240	1.7	1.6	26.7	2420
MTX300-1RZ1-R-1C300	1×300	1.8	1.7	29.6	3015





### TI /TU (MTX400)

## 0.6/1 kV XLPE Insulated, LSOH (SHF1) Sheathed Flame Retardant Power & Control Cables (Multicore)

### Application

These unarmoured power & control cables are used on board of ships in all locations for fixed installations not subject to mechanical risk complying with IEC standards 60092-352. These cables are flame retardant, low smoke & halogen free.

### Standards

- IEC 60092-350/353/360
- IEC 60332-1
- IEC 60332-3-22
- IEC 60754-1/2
- IEC 61034

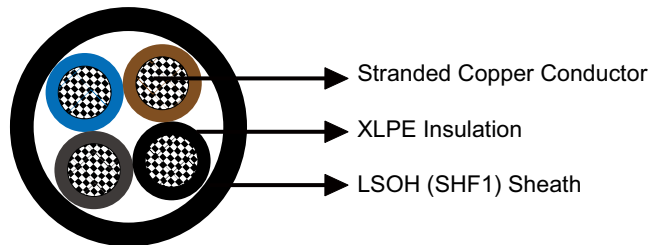

### Construction

- Conductors: Class 2 stranded copper conductor, round or sector shaped. Class 5 stranded conductors can be offered upon request.
- Insulation: XLPE.
- Filler (optional): Halogen free filling compound.
- Outer Sheath: LSOH (SHF1). SHF2 can be offered upon request.

### Core Identification

Two cores: Blue, Brown.

Three cores: Brown, Black, Grey.

Four cores: Blue, Brown, Black, Grey.

Five cores: Blue, Brown, Black, Grey, Black.

Multi cores: White with black numbers.

#### With yellow/green (optional)

Two cores + earth (3G): Yellow/green, Blue, Brown.

Three cores + earth (4G): Yellow/green, Brown, Black, Grey.

Four cores + earth (5G): Yellow/green, Blue, Brown, Black, Grey.



### Mechanical and Thermal Properties

Bending Radius for Fixed Installations:  $6 \times OD$  ( $OD > 25\text{mm}$ );  $4 \times OD$  ( $OD \leq 25\text{mm}$ )  
 Temperature Range:  $-30^{\circ}\text{C} \sim +80^{\circ}\text{C}$

### Dimensions and Weight

**MTX400 1RZ1-R Multicore 0.6/1kV (-R stands for class 2 conductor. For class 5 conductor, please change -R to -F)**

Part No.	Construction No. of cores $\times$ Cross section ( $\text{mm}^2$ )	Nominal Insulation Thickness mm	Nominal Sheath Thickness mm	Nominal Overall Diameter mm	Nominal Weight kg/km
MTX400-1RZ1-R-2C1.5	2 $\times$ 1.5	0.7	1.1	8.4	80
MTX400-1RZ1-R-2C2.5	2 $\times$ 2.5	0.7	1.1	9.2	100
MTX400-1RZ1-R-2C4	2 $\times$ 4	0.7	1.1	10.7	135
MTX400-1RZ1-R-2C6	2 $\times$ 6	0.7	1.2	12.0	185
MTX400-1RZ1-R-2C10	2 $\times$ 10	0.7	1.2	13.7	270
MTX400-1RZ1-R-2C16	2 $\times$ 16	0.7	1.3	16.0	400
MTX400-1RZ1-R-2C25	2 $\times$ 25	0.9	1.3	18.8	700
MTX400-1RZ1-R-2C35	2 $\times$ 35	0.9	1.3	21.4	930
MTX400-1RZ1-R-2C50	2 $\times$ 50	1.0	1.3	24.2	1290
MTX400-1RZ1-R-3C1.5(3G1.5)	3 $\times$ (G)1.5	0.7	1.1	8.8	100
MTX400-1RZ1-R-3C2.5(3G2.5)	3 $\times$ (G)2.5	0.7	1.1	9.8	130
MTX400-1RZ1-R-3C4(3G4)	3 $\times$ (G)4	0.7	1.2	11.6	190
MTX400-1RZ1-R-3C6(3G6)	3 $\times$ (G)6	0.7	1.2	12.8	250
MTX400-1RZ1-R-3C10	3 $\times$ 10	0.7	1.3	14.8	380
MTX400-1RZ1-R-3C16(3G16)	3 $\times$ 16	0.7	1.3	17.1	560
MTX400-1RZ1-R-3C25	3 $\times$ 25	0.9	1.5	20.7	875
MTX400-1RZ1-R-3C35	3 $\times$ 35	0.9	1.6	23.5	1220
MTX400-1RZ1-R-3C35S	3 $\times$ 35 (sector shaped)	0.9	1.5	20.1	1135
MTX400-1RZ1-R-3C50	3 $\times$ 50	1.0	1.7	26.7	1780
MTX400-1RZ1-R-3C50S	3 $\times$ 50 (sector shaped)	1.0	1.7	22.8	1530
MTX400-1RZ1-R-3C70S	3 $\times$ 70 (sector shaped)	1.1	1.8	26.7	2150
MTX400-1RZ1-R-3C95S	3 $\times$ 95 (sector shaped)	1.1	1.9	30.2	2900
MTX400-1RZ1-R-3C120S	3 $\times$ 120 (sector shaped)	1.2	2.1	34.0	3675
MTX400-1RZ1-R-4C1.5(4G1.5)	4 $\times$ (G)1.5	0.7	1.1	9.6	120
MTX400-1RZ1-R-4C2.5(4G2.5)	4 $\times$ (G)2.5	0.7	1.1	10.7	165
MTX400-1RZ1-R-4C4(4G4)	4 $\times$ (G)4	0.7	1.2	12.8	240
MTX400-1RZ1-R-4C6(4G6)	4 $\times$ (G)6	0.7	1.2	14.1	320
MTX400-1RZ1-R-4C10(4G10)	4 $\times$ (G)10	0.7	1.3	16.3	490



# IEC Standard Caledonian Offshore & Marine Cables

## MariTox Marine Flame Retardant Power & Control Cables



[www.caledonian-cables.co.uk](http://www.caledonian-cables.co.uk)

Part No.	Construction No. of cores×Cross section(mm <sup>2</sup> )	Nominal Insulation Thickness mm	Nominal Sheath Thickness mm	Nominal Overall Diameter mm	Nominal Weight kg/km
MTX400-1RZ1-R-4C16(4G16)	4×(G)16	0.7	1.4	19.1	740
MTX400-1RZ1-R-4C25(4G25)	4×(G)25	0.9	1.5	22.8	1145
MTX400-1RZ1-R-4G35	4G35	0.9	1.7	26.0	1515
MTX400-1RZ1-R-4G50	4G50	1.0	1.8	29.7	2340
MTX400-1RZ1-R-5C1.5(5G1.5)	5×(G)1.5	0.7	1.1	10.5	145
MTX400-1RZ1-R-5C2.5(5G2.5)	5×(G)2.5	0.7	1.2	11.9	205
MTX400-1RZ1-R-5G6	5G6	0.7	1.3	15.7	400
MTX400-1RZ1-R-5G16	5G16	0.7	1.5	21.2	920
MTX400-1RZ1-R-6C1.5	6×1.5	0.7	1.2	11.6	180
MTX400-1RZ1-R-7C1.5	7×1.5	0.7	1.2	11.7	195
MTX400-1RZ1-R-8C1.5(8G1.5)	8×(G)1.5	0.7	1.2	12.7	225
MTX400-1RZ1-R-10C1.5	10×1.5	0.7	1.3	14.8	275
MTX400-1RZ1-R-12C1.5	12×1.5	0.7	1.3	15.3	315
MTX400-1RZ1-R-16C1.5	16×1.5	0.7	1.4	17.2	410
MTX400-1RZ1-R-19C1.5	19×1.5	0.7	1.4	18.1	470
MTX400-1RZ1-R-24C1.5	24×1.5	0.7	1.5	21.3	620
MTX400-1RZ1-R-5C2.5	5×2.5	0.7	1.2	11.9	210
MTX400-1RZ1-R-7C2.5	7×2.5	0.7	1.2	13.2	280
MTX400-1RZ1-R-12C2.5	12×2.5	0.7	1.3	17.4	460
MTX400-1RZ1-R-19C2.5	19×2.5	0.7	1.4	20.6	690
MTX400-1RZ1-R-24C2.5	24×2.5	0.7	1.5	24.3	880
MTX400-1RZ1-R-27C2.5	27×2.5	0.7	1.5	24.6	970
MTX400-1RZ1-R-37C2.5	37×2.5	0.7	1.6	27.7	1300





### TOI /TOU (MTX300)

### 0.6/1 kV XLPE Insulated, LSOH (SHF1) Sheathed, Armoured Flame Retardant Power & Control Cables (Single Core)

---

#### Application

These armoured cables are used on board of ships in all locations for fixed installations where cable protection is required. These cables are flame retardant, low smoke & halogen free.

#### Standards

- IEC 60092-350/353/360
- IEC 60332-1
- IEC 60332-3-22
- IEC 60754-1/2
- IEC 61034

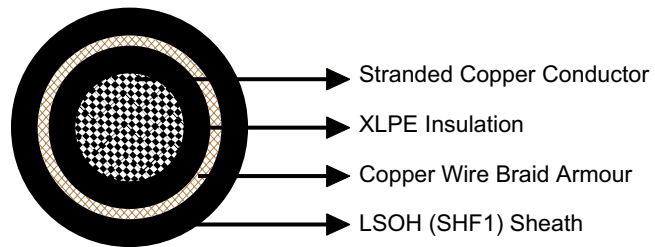

#### Construction

- Conductors: Class 2 stranded copper conductor, round or sector shaped. Class 5 stranded conductors can be offered upon request.
- Insulation: XLPE.
- Armour: Copper wire braid.
- Outer Sheath: LSOH (SHF1). SHF2 can be offered upon request.

#### Core Identification

- Single core: Black.

#### Mechanical and Thermal Properties

Bending Radius for Fixed Installations:  $6 \times OD$

Temperature Range:  $-30^{\circ}\text{C} \sim +80^{\circ}\text{C}$



### Dimensions and Weight

**MTX300 1RMZ1-R Single Core Armoured 0.6/1kV (-R stands for class 2 conductor. For class 5 conductor, please change -R to -F)**

Part No.	Construction No. of cores×Cross section(mm <sup>2</sup> )	Nominal Insulation Thickness mm	Nominal Sheath Thickness mm	Nominal Overall Diameter mm	Nominal Weight kg/km
MTX300-1RMZ1-R-1C1.5	1×1.5	0.7	1.1	6.3	70
MTX300-1RMZ1-R-1C2.5	1×2.5	0.7	1.1	6.7	80
MTX300-1RMZ1-R-1C4	1×4	0.7	1.1	7.0	100
MTX300-1RMZ1-R-1C6	1×6	0.7	1.1	7.6	120
MTX300-1RMZ1-R-1C10	1×10	0.7	1.1	8.4	180
MTX300-1RMZ1-R-1C16	1×16	0.7	1.1	9.8	245
MTX300-1RMZ1-R-1C25	1×25	0.9	1.2	11.7	355
MTX300-1RMZ1-R-1C35	1×35	0.9	1.2	13.0	455
MTX300-1RMZ1-R-1C50	1×50	1.0	1.3	15.0	620
MTX300-1RMZ1-R-1C70	1×70	1.1	1.4	17.2	850
MTX300-1RMZ1-R-1C95	1×95	1.1	1.4	19.1	1115
MTX300-1RMZ1-R-1C120	1×120	1.2	1.5	21.1	1385
MTX300-1RMZ1-R-1C150	1×150	1.4	1.6	23.2	1690
MTX300-1RMZ1-R-1C185	1×185	1.6	1.6	25.5	2065
MTX300-1RMZ1-R-1C240	1×240	1.7	1.7	28.4	2640
MTX300-1RMZ1-R-1C300	1×300	1.8	1.8	31.3	3260





### TFOI/TFOU (MTX400)

### 0.6/1 kV XLPE Insulated, LSOH (SHF1) Sheathed, Armoured Flame Retardant Power & Control Cables (Multicore)

---

#### Application

These armoured cables are used on board of ships in all locations for fixed installations where cable protection is required. These cables are flame retardant, low smoke & halogen free.

#### Standards

- IEC 60092-350/353/360
- IEC 60332-1
- IEC 60332-3-22
- IEC 60754-1/2
- IEC 61034

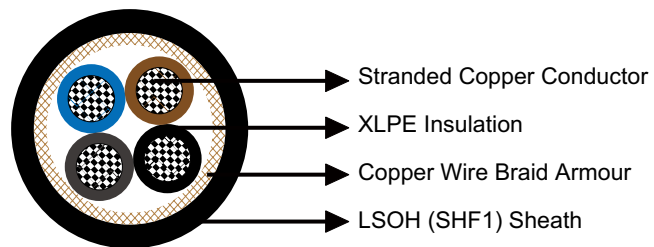

#### Construction

- Conductors: Class 2 stranded copper conductor, round or sector shaped. Class 5 stranded conductors can be offered upon request.
- Insulation: XLPE.
- Inner Covering: Lapping.
- Armour: Copper wire braid.
- Outer Sheath: LSOH (SHF1). SHF2 can be offered upon request.

#### Core Identification

Two cores: Blue, Brown.

Three cores: Brown, Black, Grey.

Four cores: Blue, Brown, Black, Grey.

Five cores: Blue, Brown, Black, Grey, Black.

Multi cores: White with black numbers

**With yellow/green (optional)**

Two cores + earth (3G): Yellow/green, Blue, Brown.

Three cores + earth (4G): Yellow/green, Brown, Black, Grey.



Four cores + earth (5G): Yellow/green, Blue, Brown, Black, Grey.

### Mechanical and Thermal Properties

Bending Radius for Fixed Installations:  $6 \times OD$

Temperature Range:  $-30^{\circ}\text{C} \sim +80^{\circ}\text{C}$

### Dimensions and Weight

**MTX400 1RMZ1-R Multicore Armoured 0.6/1kV (-R stands for class 2 conductor. For class 5 conductor, please change -R to -F)**

Part No.	Construction No. of cores $\times$ Cross section ( $\text{mm}^2$ )	Nominal Insulation Thickness mm	Nominal Sheath Thickness mm	Nominal Overall Diameter mm	Nominal Weight kg/km
MTX400-1RMZ1-R-2C1.5	2 $\times$ 1.5	0.7	1.1	9.3	120
MTX400-1RMZ1-R-2C2.5	2 $\times$ 2.5	0.7	1.1	10.1	150
MTX400-1RMZ1-R-2C4	2 $\times$ 4	0.7	1.2	11.8	195
MTX400-1RMZ1-R-2C6	2 $\times$ 6	0.7	1.2	13.3	275
MTX400-1RMZ1-R-2C10	2 $\times$ 10	0.7	1.3	15.3	385
MTX400-1RMZ1-R-2C16	2 $\times$ 16	0.7	1.4	18.0	595
MTX400-1RMZ1-R-2C25	2 $\times$ 25	0.9	1.5	21.3	820
MTX400-1RMZ1-R-2C35	2 $\times$ 35	0.9	1.5	23.9	1140
MTX400-1RMZ1-R-2C50	2 $\times$ 50	1.0	1.5	26.7	1500
MTX400-1RMZ1-R-3C1.5(3G1.5)	3 $\times$ (G)1.5	0.7	1.1	9.8	145
MTX400-1RMZ1-R-3C2.5(3G2.5)	3 $\times$ (G)2.5	0.7	1.1	10.7	180
MTX400-1RMZ1-R-3C4	3 $\times$ 4	0.7	1.2	12.5	245
MTX400-1RMZ1-R-3C6	3 $\times$ 6	0.7	1.3	14.3	345
MTX400-1RMZ1-R-3C10	3 $\times$ 10	0.7	1.3	16.2	490
MTX400-1RMZ1-R-3C16	3 $\times$ 16	0.7	1.4	19.1	755
MTX400-1RMZ1-R-3C25	3 $\times$ 25	0.9	1.6	22.7	1095
MTX400-1RMZ1-R-3C35	3 $\times$ 35	0.9	1.6	24.9	1340
MTX400-1RMZ1-R-3C35S	3 $\times$ 35 (sector shaped)	0.9	1.6	22.0	1320
MTX400-1RMZ1-R-3C50	3 $\times$ 50	1.0	1.6	27.1	1750
MTX400-1RMZ1-R-3C50S	3 $\times$ 50 (sector shaped)	1.0	1.6	24.8	1820
MTX400-1RMZ1-R-3C70S	3 $\times$ 70 (sector shaped)	1.1	2.0	29.7	2575
MTX400-1RMZ1-R-3C95S	3 $\times$ 95 (sector shaped)	1.1	2.1	33.1	3435
MTX400-1RMZ1-R-3C120S	3 $\times$ 120 (sector shaped)	1.2	2.2	36.0	4070
MTX400-1RMZ1-R-3C150S	3 $\times$ 150 (sector shaped)	1.4	2.4	40.9	5435
MTX400-1RMZ1-R-4C1.5(4G1.5)	4 $\times$ (G)1.5	0.7	1.1	10.5	170
MTX400-1RMZ1-R-4C2.5(4G2.5)	4 $\times$ (G)2.5	0.7	1.2	11.8	225





# IEC Standard Caledonian Offshore & Marine Cables

## MariTox Marine Flame Retardant Power & Control Cables

[www.caledonian-cables.co.uk](http://www.caledonian-cables.co.uk)

Part No.	Construction No. of cores×Cross section(mm <sup>2</sup> )	Nominal Insulation Thickness mm	Nominal Sheath Thickness mm	Nominal Overall Diameter mm	Nominal Weight kg/km
MTX400-1RMZ1-R-4C4	4×4	0.7	1.3	14.3	335
MTX400-1RMZ1-R-4C6	4×6	0.7	1.3	15.6	425
MTX400-1RMZ1-R-4C10	4×10	0.7	1.4	17.9	625
MTX400-1RMZ1-R-4C16	4×16	0.7	1.5	21.1	935
MTX400-1RMZ1-R-4C25	4×25	0.9	1.6	24.4	1345
MTX400-1RMZ1-R-4C35	4×35	0.9	1.7	27.5	1715
MTX400-1RMZ1-R-4C35S	4×35 (sector shaped)	0.9	1.7	24.3	1700
MTX400-1RMZ1-R-4C50	4×50	1.0	1.6	29.9	2400
MTX400-1RMZ1-R-4C50S	4×50(sector shaped)	1.0	1.6	27.3	2300
MTX400-1RMZ1-R-4C70S	4×70(sector shaped)	1.1	2.1	32.8	3250
MTX400-1RMZ1-R-4C95S	4×95(sector shaped)	1.1	2.2	37.3	4390
MTX400-1RMZ1-R-5C1.5(5G1.5)	5×(G)1.5	0.7	1.2	11.7	205
MTX400-1RMZ1-R-5C2.5(5G2.5)	5×(G)2.5	0.7	1.2	12.8	265
MTX400-1RMZ1-R-5G4	5G4	0.7	1.2	14.8	360
MTX400-1RMZ1-R-6C1.5	6×1.5	0.7	1.2	12.7	240
MTX400-1RMZ1-R-7C1.5	7×1.5	0.7	1.2	12.7	260
MTX400-1RMZ1-R-8C1.5	8×1.5	0.7	1.2	15.5	340
MTX400-1RMZ1-R-10C1.5	10×1.5	0.7	1.3	16.2	390
MTX400-1RMZ1-R-12C1.5	12×1.5	0.7	1.4	16.9	440
MTX400-1RMZ1-R-16C1.5	16×1.5	0.7	1.4	18.6	550
MTX400-1RMZ1-R-19C1.5	19×1.5	0.7	1.5	19.7	620
MTX400-1RMZ1-R-24C1.5	24×1.5	0.7	1.6	22.9	800
MTX400-1RMZ1-R-5C2.5	5×2.5	0.7	1.2	12.9	290
MTX400-1RMZ1-R-7C2.5	7×2.5	0.7	1.2	14.6	390
MTX400-1RMZ1-R-12C2.5	12×2.5	0.7	1.4	18.7	610
MTX400-1RMZ1-R-19C2.5	19×2.5	0.7	1.5	21.8	870
MTX400-1RMZ1-R-24C2.5	24×2.5	0.7	1.6	25.6	1100
MTX400-1RMZ1-R-27C2.5	27×2.5	0.7	1.7	26.1	1200
MTX400-1RMZ1-R-37C2.5	37×2.5	0.7	1.9	29.2	1560



### RI / RU (MTX300)

## 0.6/1 kV HEPR Insulated, LSOH (SHF1) Sheathed Flame Retardant Power & Control Cables (Single Core)

### Application

These cables are used for fixed installations on ships and offshore units in all locations. These cables are flame retardant, low smoke & halogen free.

### Standards

- DIN 89160/98
- IEC 60092-353
- IEC 60332-1
- IEC 60332-3-22
- IEC 60754-1/2
- IEC 61034

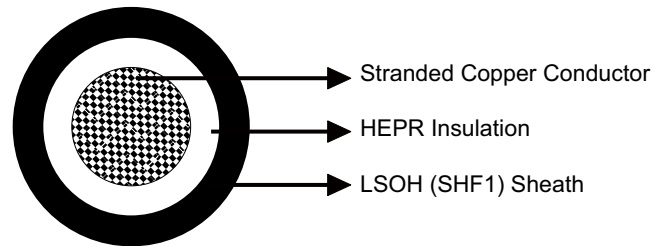

### Construction

- Conductors: Class 2 stranded copper conductor.
- Insulation: HEPR.
- Outer Sheath: LSOH (SHF1).

### Core Identification

Single core: Natural colour (beige).

### Mechanical and Thermal Properties

Bending Radius for Fixed Installations:  $6 \times OD$  ( $OD > 25\text{mm}$ );  $4 \times OD$  ( $OD \leq 25\text{mm}$ )  
Temperature Range:  $-20^{\circ}\text{C} \sim +75^{\circ}\text{C}$





# IEC Standard Caledonian Offshore & Marine Cables

## MariTox Marine Flame Retardant Power & Control Cables

[www.caledonian-cables.co.uk](http://www.caledonian-cables.co.uk)

### Dimensions and Weight

Part No.	Construction No. of cores×Cross section(mm <sup>2</sup> )	Nominal Insulation Thickness mm	Nominal Sheath Thickness mm	Nominal Overall Diameter mm	Nominal Weight kg/km
MTX300-1G7Z1-R-1C4	1×4	0.7	1.2	6.5	80
MTX300-1G7Z1-R-1C6	1×6	0.7	1.2	7.5	110
MTX300-1G7Z1-R-1C10	1×10	0.7	1.2	8.5	150
MTX300-1G7Z1-R-1C16	1×16	0.7	1.2	9.5	220
MTX300-1G7Z1-R-1C25	1×25	0.9	1.2	11.0	320
MTX300-1G7Z1-R-1C35	1×35	0.9	1.2	12.0	420
MTX300-1G7Z1-R-1C50	1×50	1.0	1.3	13.5	560
MTX300-1G7Z1-R-1C70	1×70	1.1	1.3	15.5	780
MTX300-1G7Z1-R-1C95	1×95	1.1	1.4	17.8	1030
MTX300-1G7Z1-R-1C120	1×120	1.2	1.4	19.3	1290
MTX300-1G7Z1-R-1C150	1×150	1.4	1.5	21.3	1590
MTX300-1G7Z1-R-1C185	1×185	1.6	1.5	23.5	1960
MTX300-1G7Z1-R-1C240	1×240	1.7	1.6	26.5	2560
MTX300-1G7Z1-R-1C300	1×300	1.8	1.7	29.5	3200







### RI/RU (MTX400)

## 0.6/1 kV HEPR Insulated, LSOH (SHF1) Sheathed Flame Retardant Power & Control Cables (Multicore)

### Application

These cables are used for fixed installations on ships and offshore units in all locations. These cables are flame retardant, low smoke & halogen free.

### Standards

- DIN 89160/98
- IEC 60092-353
- IEC 60332-1
- IEC 60332-3-22
- IEC 60754-1/2
- IEC 61034

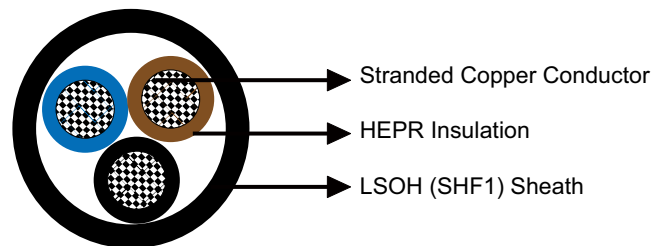

### Construction

- Conductors: Class 2 stranded copper conductor.
- Insulation: HEPR.
- Outer Sheath: LSOH (SHF1).

### Core Identification

Two cores: Black, Blue.

Three cores: Black, Blue, Brown.

Four cores: Black, Blue, Brown, Black.

Five cores: Black, Blue, Brown, Black, Black.

Multi cores: All cores natural coloured, printed with numbers, starting in center with number 1.

Cables with 3 cores and more also with green/yellow core (has to be stated in order).

### Mechanical and Thermal Properties

Bending Radius for Fixed Installations:  $6 \times OD$  ( $OD > 25\text{mm}$ );  $4 \times OD$  ( $OD \leq 25\text{mm}$ )

Temperature Range:  $-20^{\circ}\text{C} \sim +75^{\circ}\text{C}$



# IEC Standard Caledonian Offshore & Marine Cables

## MariTox Marine Flame Retardant Power & Control Cables

[www.caledonian-cables.co.uk](http://www.caledonian-cables.co.uk)

### Dimensions and Weight

Part No.	Construction No. of cores×Cross section(mm <sup>2</sup> )	Nominal Insulation Thickness mm	Nominal Sheath Thickness mm	Nominal Overall Diameter mm	Nominal Weight kg/km
MTX400-1G7Z1-R-2C1.5	2×1.5	0.7	1.0	8.4	130
MTX400-1G7Z1-R-2C2.5	2×2.5	0.7	1.1	9.3	170
MTX400-1G7Z1-R-2C4	2×4	0.7	1.1	10.5	220
MTX400-1G7Z1-R-2C6	2×6	0.7	1.2	11.8	280
MTX400-1G7Z1-R-2C10	2×10	0.7	1.2	13.8	410
MTX400-1G7Z1-R-2C16	2×16	0.7	1.3	16.2	590
MTX400-1G7Z1-R-2C25	2×25	0.9	1.5	20.1	880
MTX400-1G7Z1-R-3C1.5	3×1.5	0.7	1.1	8.9	160
MTX400-1G7Z1-R-3C2.5	3×2.5	0.7	1.1	9.9	210
MTX400-1G7Z1-R-3C4	3×4	0.7	1.1	11.1	270
MTX400-1G7Z1-R-3C6	3×6	0.7	1.2	12.6	350
MTX400-1G7Z1-R-3C10	3×10	0.7	1.3	14.8	510
MTX400-1G7Z1-R-3C16	3×16	0.7	1.4	17.3	750
MTX400-1G7Z1-R-3C25	3×25	0.9	1.5	21.5	1130
MTX400-1G7Z1-R-3C35	3×35	0.9	1.6	24.2	1500
MTX400-1G7Z1-R-3C50	3×50	1.0	1.8	28.5	1970
MTX400-1G7Z1-R-3C70	3×70	1.1	2.0	32.9	2770
MTX400-1G7Z1-R-3C95	3×95	1.1	2.1	37.4	3680
MTX400-1G7Z1-R-3C120	3×120	1.2	2.3	41.6	4580
MTX400-1G7Z1-R-4C1.5	4×1.5	0.7	1.1	9.8	200
MTX400-1G7Z1-R-4C2.5	4×2.5	0.7	1.1	10.9	250
MTX400-1G7Z1-R-4C4	4×4	0.7	1.2	12.3	330
MTX400-1G7Z1-R-4C6	4×6	0.7	1.2	13.9	440
MTX400-1G7Z1-R-4C10	4×10	0.7	1.3	16.3	660
MTX400-1G7Z1-R-4C16	4×16	0.7	1.4	19.2	950
MTX400-1G7Z1-R-4C25	4×25	0.9	1.6	23.9	1460
MTX400-1G7Z1-R-4C35	4×35	0.9	1.7	27.0	1920
MTX400-1G7Z1-R-4C50	4×50	1.0	1.9	30.5	2520
MTX400-1G7Z1-R-4C70	4×70	1.1	2.1	36.7	3530
MTX400-1G7Z1-R-4C95	4×95	1.1	2.3	41.7	4730
MTX400-1G7Z1-R-5C1.5	5×1.5	0.7	1.1	12.3	230
MTX400-1G7Z1-R-5C2.5	5×2.5	0.7	1.2	13.3	300
MTX400-1G7Z1-R-7C1.5	7×1.5	0.7	1.2	13.3	290
MTX400-1G7Z1-R-10C1.5	10×1.5	0.7	1.3	15.8	360
MTX400-1G7Z1-R-12C1.5	12×1.5	0.7	1.3	16.3	410
MTX400-1G7Z1-R-14C1.5	14×1.5	0.7	1.4	17.0	470
MTX400-1G7Z1-R-16C1.5	16×1.5	0.7	1.4	18.0	530
MTX400-1G7Z1-R-19C1.5	19×1.5	0.7	1.4	19.0	610
MTX400-1G7Z1-R-24C1.5	24×1.5	0.7	1.5	22.0	760



### ROI/ROU (MTX300)

### 0.6/1 kV HEPR Insulated, LSOH (SHF1) Sheathed, Screened Flame Retardant Power & Control Cables (Single Core)

#### Application

These cables are used for fixed installations on ships and offshore units in all locations and on open deck. The good screening qualities of the copper braid also reduce radio interference and electrical influences to electronics installations. These cables are flame retardant, low smoke & halogen free.

#### Standards

- DIN 89160/98
- IEC 60092-353
- IEC 60332-1
- IEC 60332-3-22
- IEC 60754-1/2
- IEC 61034

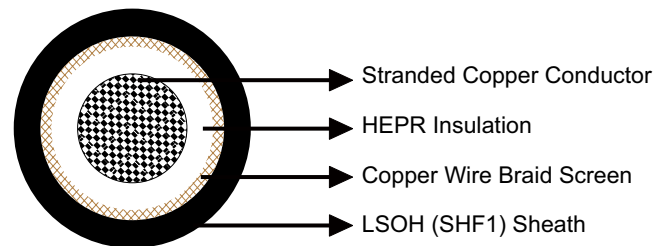

#### Construction

- Conductors: Class 2 stranded copper conductor.
- Insulation: HEPR.
- Overall Screen: Copper wire braid.
- Outer Sheath: LSOH (SHF1).

#### Core Identification

Single core: Natural colour (beige).

#### Mechanical and Thermal Properties

Bending Radius for Fixed Installations:  $6 \times OD$   
Temperature Range:  $-20^{\circ}\text{C} \sim +75^{\circ}\text{C}$



# IEC Standard Caledonian Offshore & Marine Cables

## MariTox Marine Flame Retardant Power & Control Cables

[www.caledonian-cables.co.uk](http://www.caledonian-cables.co.uk)

### Dimensions and Weight

Part No.	Construction No. of cores×Cross section(mm <sup>2</sup> )	Nominal Insulation Thickness mm	Nominal Sheath Thickness mm	Nominal Overall Diameter mm	Nominal Weight kg/km
MTX300-1G7MZ1-R-1C4	1×4	0.7	1.2	7.3	110
MTX300-1G7MZ1-R-1C6	1×6	0.7	1.2	8.3	140
MTX300-1G7MZ1-R-1C10	1×10	0.7	1.2	9.3	190
MTX300-1G7MZ1-R-1C16	1×16	0.7	1.2	10.3	270
MTX300-1G7MZ1-R-1C25	1×25	0.9	1.2	12.3	380
MTX300-1G7MZ1-R-1C35	1×35	0.9	1.2	13.3	480
MTX300-1G7MZ1-R-1C50	1×50	1.0	1.3	15.3	660
MTX300-1G7MZ1-R-1C70	1×70	1.1	1.4	17.3	900
MTX300-1G7MZ1-R-1C95	1×95	1.1	1.4	19.5	1170
MTX300-1G7MZ1-R-1C120	1×120	1.2	1.5	21.0	1410
MTX300-1G7MZ1-R-1C150	1×150	1.4	1.6	22.8	1750
MTX300-1G7MZ1-R-1C185	1×185	1.6	1.6	24.8	2160
MTX300-1G7MZ1-R-1C240	1×240	1.7	1.7	27.8	2770
MTX300-1G7MZ1-R-1C300	1×300	1.8	1.8	30.3	3440





### RFOI /RFOU (MTX400)

### 0.6/1 kV HEPR Insulated, LSOH (SHF1) Sheathed, Screened Flame Retardant Power & Control Cables (Multicore)

#### Application

These cables are used for fixed installations on ships and offshore units in all locations and on open deck. The good screening qualities of the copper braid also reduce radio interference and electrical influences to electronics installations. These cables are flame retardant, low smoke & halogen free.

#### Standards

- DIN 89160/98
- IEC 60092-353
- IEC 60332-1
- IEC 60332-3-22
- IEC 60754-1/2
- IEC 61034

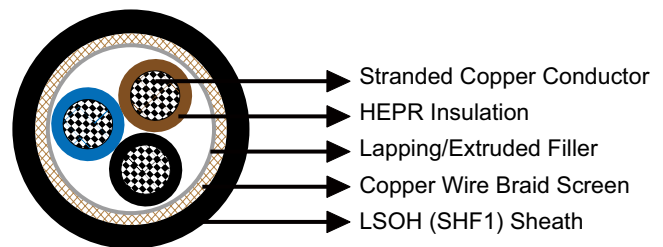

#### Construction

- Conductors: Class 2 stranded copper conductor.
- Insulation: HEPR.
- Inner Covering: Lapping or extruded filler.
- Overall Screen: Copper wire braid.
- Outer Sheath: LSOH (SHF1).

#### Core Identification

Two cores: Black, Blue.

Three cores: Black, Blue, Brown.

Four cores: Black, Blue, Brown, Black.

Five cores: Black, Blue, Brown, Black, Black.

Multi cores: All cores natural coloured, printed with numbers, starting in center with number 1.

Cables with 3 cores and more also with green/yellow core (has to be stated in order).





### Mechanical and Thermal Properties

Bending Radius for Fixed Installations:  $6 \times OD$   
Temperature Range:  $-20^{\circ}C \sim +75^{\circ}C$

### Dimensions and Weight

Part No.	Construction No. of cores $\times$ Cross section(mm <sup>2</sup> )	Nominal Insulation Thickness mm	Nominal Sheath Thickness mm	Nominal Overall Diameter mm	Nominal Weight kg/km
MTX400-1G7MZ1-R-2C1.5	2 $\times$ 1.5	0.7	1.2	11.3	180
MTX400-1G7MZ1-R-2C2.5	2 $\times$ 2.5	0.7	1.2	12.3	220
MTX400-1G7MZ1-R-2C4	2 $\times$ 4	0.7	1.3	13.3	280
MTX400-1G7MZ1-R-2C6	2 $\times$ 6	0.7	1.3	15.3	380
MTX400-1G7MZ1-R-2C10	2 $\times$ 10	0.7	1.4	17.0	500
MTX400-1G7MZ1-R-2C16	2 $\times$ 16	0.7	1.5	19.5	710
MTX400-1G7MZ1-R-2C25	2 $\times$ 25	0.9	1.6	22.0	1020
MTX400-1G7MZ1-R-3C1.5	3 $\times$ 1.5	0.7	1.2	11.8	210
MTX400-1G7MZ1-R-3C2.5	3 $\times$ 2.5	0.7	1.2	12.8	260
MTX400-1G7MZ1-R-3C4	3 $\times$ 4	0.7	1.3	13.8	330
MTX400-1G7MZ1-R-3C6	3 $\times$ 6	0.7	1.3	15.8	450
MTX400-1G7MZ1-R-3C10	3 $\times$ 10	0.7	1.4	18.0	620
MTX400-1G7MZ1-R-3C16	3 $\times$ 16	0.7	1.5	20.5	870
MTX400-1G7MZ1-R-3C25	3 $\times$ 25	0.9	1.7	23.8	1280
MTX400-1G7MZ1-R-3C35	3 $\times$ 35	0.9	1.8	26.5	1680
MTX400-1G7MZ1-R-3C50	3 $\times$ 50	1.0	2.1	29.8	2180
MTX400-1G7MZ1-R-3C70	3 $\times$ 70	1.1	2.0	34.8	3020
MTX400-1G7MZ1-R-3C95	3 $\times$ 95	1.1	2.3	39.3	4050
MTX400-1G7MZ1-R-3C120	3 $\times$ 120	1.2	2.5	43.3	5000
MTX400-1G7MZ1-R-4C1.5	4 $\times$ 1.5	0.7	1.2	12.3	240
MTX400-1G7MZ1-R-4C2.5	4 $\times$ 2.5	0.7	1.3	14.3	300
MTX400-1G7MZ1-R-4C4	4 $\times$ 4	0.7	1.3	15.3	430
MTX400-1G7MZ1-R-4C6	4 $\times$ 6	0.7	1.4	17.0	540
MTX400-1G7MZ1-R-4C10	4 $\times$ 10	0.7	1.5	19.5	780
MTX400-1G7MZ1-R-4C16	4 $\times$ 16	0.7	1.6	22.3	1090
MTX400-1G7MZ1-R-4C25	4 $\times$ 25	0.9	1.8	26.3	1630
MTX400-1G7MZ1-R-4C35	4 $\times$ 35	0.9	1.9	29.0	2120
MTX400-1G7MZ1-R-4C50	4 $\times$ 50	1.0	2.0	33.0	2750
MTX400-1G7MZ1-R-4C70	4 $\times$ 70	1.1	2.3	38.8	3900
MTX400-1G7MZ1-R-4C95	4 $\times$ 95	1.1	2.5	43.8	5160

# IEC Standard Caledonian Offshore & Marine Cables

## MariTox Marine Flame Retardant Power & Control Cables



[www.caledonian-cables.co.uk](http://www.caledonian-cables.co.uk)

Part No.	Construction No. of cores×Cross section(mm <sup>2</sup> )	Nominal Insulation Thickness mm	Nominal Sheath Thickness mm	Nominal Overall Diameter mm	Nominal Weight kg/km
MTX400-1G7MZ1-R-5C1.5	5×1.5	0.7	1.3	13.3	290
MTX400-1G7MZ1-R-5C2.5	5×2.5	0.7	1.3	15.3	400
MTX400-1G7MZ1-R-7C1.5	7×1.5	0.7	1.3	14.3	380
MTX400-1G7MZ1-R-10C1.5	10×1.5	0.7	1.3	17.0	450
MTX400-1G7MZ1-R-12C1.5	12×1.5	0.7	1.4	18.0	500
MTX400-1G7MZ1-R-14C1.5	14×1.5	0.7	1.4	18.5	560
MTX400-1G7MZ1-R-16C1.5	16×1.5	0.7	1.4	19.8	630
MTX400-1G7MZ1-R-19C1.5	19×1.5	0.7	1.5	20.5	710
MTX400-1G7MZ1-R-24C1.5	24×1.5	0.7	1.6	24.0	880





### BI/BU (MFX300)

### 0.6/1 kV Mica Tape + XLPE Insulated, LSOH (SHF1) Sheathed Fire Resistant Power & Control Cables (Single Core)

#### Application

These unarmoured fire resistant cables are used on board of ships in all locations for fixed installations where cable protection is not required. These cables are fire resistant, flame retardant, low smoke & halogen free.

#### Standards

- IEC 60092-350/353/360
- IEC 60331-21
- IEC 60332-1
- IEC 60332-3-22
- IEC 60754-1/2
- IEC 61034

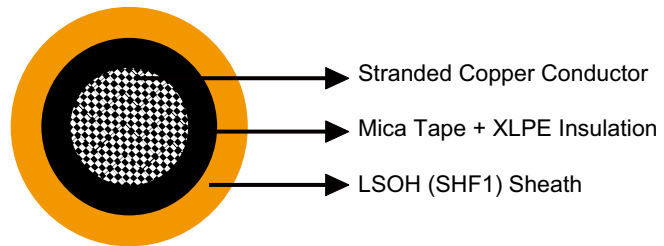

#### Construction

- Conductors: Class 2 stranded copper conductor. Class 5 stranded conductors can be offered upon request.
- Insulation: Mica tape + XLPE.
- Outer Sheath: LSOH (SHF1). SHF2 can be offered upon request.

#### Core Identification

Single core: Black.

#### Mechanical and Thermal Properties

Bending Radius for Fixed Installations:  $6 \times OD$  ( $OD > 25\text{mm}$ );  $4 \times OD$  ( $OD \leq 25\text{mm}$ )  
Temperature Range:  $-30^{\circ}\text{C} \sim +80^{\circ}\text{C}$





### Dimensions and Weight

**MFX300 1mRZ1-R Single Core 0.6/1kV (-R stands for class 2 conductor. For class 5 conductor, please change -R to -F)**

Part No.	Construction No. of cores×Cross section(mm <sup>2</sup> )	Nominal Insulation Thickness mm	Nominal Sheath Thickness mm	Nominal Overall Diameter mm	Nominal Weight kg/km
MFX300-1mRZ1-R-1C25	1×25	0.9	1.1	10.7	310
MFX300-1mRZ1-R-1C35	1×35	0.9	1.1	12.0	410
MFX300-1mRZ1-R-1C50	1×50	1.0	1.2	13.6	560
MFX300-1mRZ1-R-1C70	1×70	1.1	1.3	15.8	780
MFX300-1mRZ1-R-1C95	1×95	1.1	1.3	17.7	1030
MFX300-1mRZ1-R-1C120	1×120	1.2	1.4	19.7	1290





### BI/BU (MFX400)

### 0.6/1 kV Mica Tape + XLPE Insulated, LSOH (SHF1) Sheathed Fire Resistant Power & Control Cables (Multicore)

---

#### Application

These unarmoured fire resistant cables are used on board of ships in all locations for fixed installations where cable protection is not required. These cables are fire resistant, flame retardant, low smoke & halogen free.

#### Standards

- IEC 60092-350/353/360
- IEC 60331-21
- IEC 60332-1
- IEC 60332-3-22
- IEC 60754-1/2
- IEC 61034

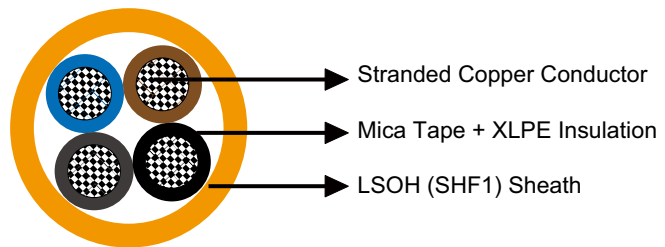

#### Construction

- Conductors: Class 2 stranded copper conductor. Class 5 stranded conductors can be offered upon request.
- Insulation: Mica tape + XLPE.
- Outer Sheath: LSOH (SHF1). SHF2 can be offered upon request.

#### Core Identification

Two cores: Blue, Brown.  
Three cores: Brown, Black, Grey.  
Four cores: Blue, Brown, Black, Grey.  
Five cores: Blue, Brown, Black, Grey, Black.  
Multi cores: White with black numbers.



### Mechanical and Thermal Properties

Bending Radius for Fixed Installations:  $6 \times OD$  ( $OD > 25\text{mm}$ );  $4 \times OD$  ( $OD \leq 25\text{mm}$ )  
 Temperature Range:  $-30^{\circ}\text{C} \sim +80^{\circ}\text{C}$

### Dimensions and Weight

**MFX400 1mRZ1-R Multicore 0.6/1kV (-R stands for class 2 conductor. For class 5 conductor, please change -R to -F)**

Part No.	Construction No. of cores $\times$ Cross section ( $\text{mm}^2$ )	Nominal Insulation Thickness mm	Nominal Sheath Thickness mm	Nominal Overall Diameter mm	Nominal Weight kg/km
MFX400-1mRZ1-R-2C1.5	2 $\times$ 1.5	0.7	1.1	8.5	85
MFX400-1mRZ1-R-2C2.5	2 $\times$ 2.5	0.7	1.1	9.5	110
MFX400-1mRZ1-R-2C4	2 $\times$ 4	0.7	1.1	11.3	140
MFX400-1mRZ1-R-2C6	2 $\times$ 6	0.7	1.2	12.6	230
MFX400-1mRZ1-R-2C10	2 $\times$ 10	0.7	1.2	14.3	330
MFX400-1mRZ1-R-2C16	2 $\times$ 16	0.7	1.3	16.6	490
MFX400-1mRZ1-R-2C25	2 $\times$ 25	0.9	1.3	19.5	750
MFX400-1mRZ1-R-2C35	2 $\times$ 35	0.9	1.5	22.0	990
MFX400-1mRZ1-R-2C50	2 $\times$ 50	1.0	1.5	24.8	1340
MFX400-1mRZ1-R-3C1.5	3 $\times$ 1.5	0.7	1.1	9.5	105
MFX400-1mRZ1-R-3C2.5	3 $\times$ 2.5	0.7	1.1	10.0	145
MFX400-1mRZ1-R-3C4	3 $\times$ 4	0.7	1.2	12.3	205
MFX400-1mRZ1-R-3C6	3 $\times$ 6	0.7	1.2	13.5	270
MFX400-1mRZ1-R-3C10	3 $\times$ 10	0.7	1.3	15.5	400
MFX400-1mRZ1-R-3C16	3 $\times$ 16	0.7	1.3	18.0	610
MFX400-1mRZ1-R-3C25	3 $\times$ 25	0.9	1.5	21.4	920
MFX400-1mRZ1-R-3C35	3 $\times$ 35	0.9	1.6	24.2	1330
MFX400-1mRZ1-R-3C50	3 $\times$ 50	1.0	1.7	27.5	1830
MFX400-1mRZ1-R-3C70	3 $\times$ 70	1.1	1.8	32.0	2570
MFX400-1mRZ1-R-3C70S	3 $\times$ 70 (sector shaped)	1.1	1.8	27.5	2370
MFX400-1mRZ1-R-3C95	3 $\times$ 95	1.1	1.9	36.4	3360
MFX400-1mRZ1-R-3C95S	3 $\times$ 95 (sector shaped)	1.1	1.9	31.1	3130
MFX400-1mRZ1-R-3C120	3 $\times$ 120	1.2	2.1	40.7	4180
MFX400-1mRZ1-R-3C120S	3 $\times$ 120 (sector shaped)	1.2	2.1	34.4	3930
MFX400-1mRZ1-R-4C1.5	4 $\times$ 1.5	0.7	1.1	10.0	135
MFX400-1mRZ1-R-4C2.5	4 $\times$ 2.5	0.7	1.1	11.2	180
MFX400-1mRZ1-R-4C4	4 $\times$ 4	0.7	1.2	13.5	260
MFX400-1mRZ1-R-4C6	4 $\times$ 6	0.7	1.2	14.8	350





# IEC Standard Caledonian Offshore & Marine Cables

## MariFlex Marine Fire Resistant Power & Control Cables

[www.caledonian-cables.co.uk](http://www.caledonian-cables.co.uk)

Part No.	Construction No. of cores×Cross section(mm <sup>2</sup> )	Nominal Insulation Thickness mm	Nominal Sheath Thickness mm	Nominal Overall Diameter mm	Nominal Weight kg/km
MFX400-1mRZ1-R-4C10	4×10	0.7	1.3	17.0	530
MFX400-1mRZ1-R-4C16	4×16	0.7	1.4	19.8	800
MFX400-1mRZ1-R-4C25	4×25	0.9	1.5	23.5	1230
MFX400-1mRZ1-R-4C35	4×35	0.9	1.7	26.7	1650
MFX400-1mRZ1-R-5C1.5	5×1.5	0.7	1.1	11.0	170
MFX400-1mRZ1-R-7C1.5	7×1.5	0.7	1.2	12.6	210
MFX400-1mRZ1-R-12C1.5	12×1.5	0.7	1.3	16.5	350
MFX400-1mRZ1-R-19C1.5	19×1.5	0.7	1.4	19.6	520
MFX400-1mRZ1-R-27C1.5	27×1.5	0.7	1.5	23.3	730
MFX400-1mRZ1-R-37C1.5	37×1.5	0.7	1.6	26.3	980
MFX400-1mRZ1-R-5C2.5	5×2.5	0.7	1.2	12.5	240
MFX400-1mRZ1-R-7C2.5	7×2.5	0.7	1.2	14.1	300
MFX400-1mRZ1-R-12C2.5	12×2.5	0.7	1.3	18.6	490
MFX400-1mRZ1-R-19C2.5	19×2.5	0.7	1.4	22.1	750
MFX400-1mRZ1-R-27C2.5	27×2.5	0.7	1.5	26.4	1060





### BOI/BOU (MFX300)

### 0.6/1 kV Mica Tape + XLPE Insulated, LSOH (SHF1) Sheathed, Armoured Fire Resistant Power & Control Cables (Single Core)

#### Application

These armoured fire resistant cables are used on board of ships in all locations for fixed installations where cable protection is required. These cables are fire resistant, flame retardant, low smoke & halogen free.

#### Standards

- IEC 60092-350/353/360
- IEC 60331-21
- IEC 60332-1
- IEC 60332-3-22
- IEC 60754-1/2
- IEC 61034

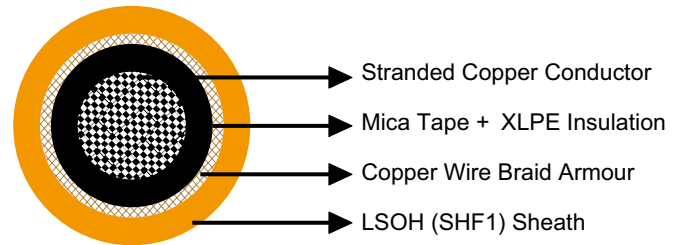

#### Construction

- Conductors: Class 2 stranded copper conductor. Class 5 stranded conductors can be offered upon request.
- Insulation: Mica tape + XLPE.
- Armour: Copper wire braid.
- Outer Sheath: LSOH (SHF1). SHF2 can be offered upon request.

#### Core Identification

Single core: Black.

#### Mechanical and Thermal Properties

Bending Radius for Fixed Installations:  $6 \times OD$   
Temperature Range:  $-30^{\circ}\text{C} \sim +80^{\circ}\text{C}$



### Dimensions and Weight

**MF300 1mRMZ1-R Single Core Armoured 0.6/1kV (-R stands for class 2 conductor. For class 5 conductor, please change -R to -F)**

Part No.	Construction No. of cores×Cross section(mm <sup>2</sup> )	Nominal Insulation Thickness mm	Nominal Sheath Thickness mm	Nominal Overall Diameter mm	Nominal Weight kg/km
MF300-1mRMZ1-R-1C25	1×25	0.9	1.2	13.0	410
MF300-1mRMZ1-R-1C35	1×35	0.9	1.2	14.6	550
MF300-1mRMZ1-R-1C50	1×50	1.0	1.3	15.8	720
MF300-1mRMZ1-R-1C70	1×70	1.1	1.4	17.8	960
MF300-1mRMZ1-R-1C95	1×95	1.1	1.4	20.7	1250
MF300-1mRMZ1-R-1C120	1×120	1.2	1.5	22.8	1540





### BFOI/BFOU (MFX400)

### 0.6/1 kV Mica Tape + XLPE Insulated, LSOH (SHF1) Sheathed, Armoured Fire Resistant Power & Control Cables (Multicore)

#### Application

These armoured fire resistant cables are used on board of ships in all locations for fixed installations where cable protection is required. These cables are fire resistant, flame retardant, low smoke & halogen free.

#### Standards

- IEC 60092-350/353/360
- IEC 60331-21
- IEC 60332-1
- IEC 60332-3-22
- IEC 60754-1/2
- IEC 61034

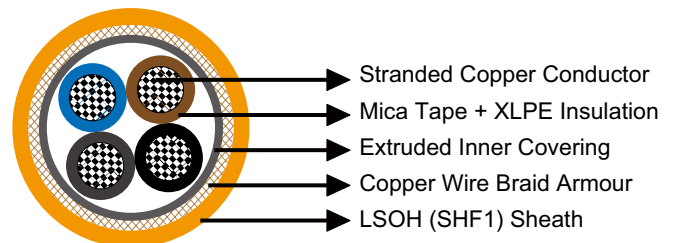

#### Construction

- Conductors: Class 2 stranded copper conductor. Class 5 stranded conductors can be offered upon request.
- Insulation: Mica tape + XLPE.
- Inner Covering: Extruded inner covering.
- Armour: Copper wire braid.
- Outer Sheath: LSOH (SHF1). SHF2 can be offered upon request.

#### Core Identification

Two cores: Blue, Brown.

Three cores: Brown, Black, Grey.

Four cores: Blue, Brown, Black, Grey.

Five cores: Blue, Brown, Black, Grey, Black.

Multi cores: White with black numbers.





### Mechanical and Thermal Properties

Bending Radius for Fixed Installations:  $6 \times OD$   
 Temperature Range:  $-30^{\circ}\text{C} \sim +80^{\circ}\text{C}$

### Dimensions and Weight

**MFX400 1mRMZ1-R Multicore Armoured 0.6/1kV (-R stands for class 2 conductor. For class 5 conductor, please change -R to -F)**

Part No.	Construction No. of cores×Cross section(mm <sup>2</sup> )	Nominal Insulation Thickness mm	Nominal Sheath Thickness mm	Nominal Overall Diameter mm	Nominal Weight kg/km
MFX400-1mRMZ1-R-2C1.5	2×1.5	0.7	1.1	10.5	180
MFX400-1mRMZ1-R-2C2.5	2×2.5	0.7	1.1	11.7	230
MFX400-1mRMZ1-R-2C4	2×4	0.7	1.2	12.5	290
MFX400-1mRMZ1-R-2C6	2×6	0.7	1.2	14.4	400
MFX400-1mRMZ1-R-2C10	2×10	0.9	1.3	16.6	570
MFX400-1mRMZ1-R-2C16	2×16	0.9	1.4	19.0	770
MFX400-1mRMZ1-R-2C25	2×25	0.9	1.5	22.8	1130
MFX400-1mRMZ1-R-2C35	2×35	0.9	1.5	25.0	1420
MFX400-1mRMZ1-R-2C50	2×50	1.0	1.5	28.0	1860
MFX400-1mRMZ1-R-3C1.5	3×1.5	0.7	1.1	11.2	210
MFX400-1mRMZ1-R-3C2.5	3×2.5	0.7	1.1	12.2	260
MFX400-1mRMZ1-R-3C4	3×4	0.7	1.2	13.1	340
MFX400-1mRMZ1-R-3C6	3×6	0.7	1.3	15.3	480
MFX400-1mRMZ1-R-3C10	3×10	0.7	1.3	17.3	680
MFX400-1mRMZ1-R-3C16	3×16	0.7	1.4	19.6	930
MFX400-1mRMZ1-R-3C25	3×25	0.9	1.6	24.1	1380
MFX400-1mRMZ1-R-3C35	3×35	0.9	1.6	26.4	1770
MFX400-1mRMZ1-R-3C50	3×50	1.0	1.6	29.6	2350
MFX400-1mRMZ1-R-3C70S	3×70 (sector shaped)	1.1	2.0	31.9	2930
MFX400-1mRMZ1-R-3C95S	3×95 (sector shaped)	1.1	2.1	36.1	3870
MFX400-1mRMZ1-R-3C120S	3×120 (sector shaped)	1.2	2.2	39.6	4770
MFX400-1mRMZ1-R-4C1.5	4×1.5	0.7	1.1	12.1	250
MFX400-1mRMZ1-R-4C2.5	4×2.5	0.7	1.2	12.9	300
MFX400-1mRMZ1-R-4C4	4×4	0.7	1.3	15.0	440
MFX400-1mRMZ1-R-4C6	4×6	0.7	1.3	16.6	570
MFX400-1mRMZ1-R-4C10	4×10	0.7	1.4	18.7	810
MFX400-1mRMZ1-R-4C16	4×16	0.7	1.5	21.8	1160
MFX400-1mRMZ1-R-4C25	4×25	0.9	1.6	26.9	1720



# IEC Standard Caledonian Offshore & Marine Cables

## MariFlex Marine Fire Resistant Power & Control Cables



[www.caledonian-cables.co.uk](http://www.caledonian-cables.co.uk)

Part No.	Construction No. of cores×Cross section(mm <sup>2</sup> )	Nominal Insulation Thickness mm	Nominal Sheath Thickness mm	Nominal Overall Diameter mm	Nominal Weight kg/km
MFX400-1mRMZ1-R-4C35	4×35	0.9	1.7	29.7	2220
MFX400-1mRMZ1-R-5C1.5	5×1.5	0.7	1.2	12.8	280
MFX400-1mRMZ1-R-7C1.5	7×1.5	0.7	1.2	14.3	370
MFX400-1mRMZ1-R-12C1.5	12×1.5	0.7	1.4	17.9	570
MFX400-1mRMZ1-R-19C1.5	19×1.5	0.7	1.5	20.7	790
MFX400-1mRMZ1-R-27C1.5	27×1.5	0.7	1.7	24.4	1100
MFX400-1mRMZ1-R-37C1.5	37×1.5	0.7	1.9	27.3	1380
MFX400-1mRMZ1-R-5C2.5	5×2.5	0.7	1.2	14.7	400
MFX400-1mRMZ1-R-7C2.5	7×2.5	0.7	1.2	15.8	480
MFX400-1mRMZ1-R-12C2.5	12×2.5	0.7	1.4	20.3	780
MFX400-1mRMZ1-R-19C2.5	19×2.5	0.7	1.5	23.4	1070
MFX400-1mRMZ1-R-27C2.5	27×2.5	0.7	1.7	27.9	1500





### BOI/BOU (MFX300)

### 0.6/1 kV Fire Barriers + HEPR Insulated, LSOH (SHF1) Sheathed, Screened Fire Resistant Power & Control Cables (Single Core)

#### Application

These cables are used for fixed installations on ships and offshore units in all locations and on open deck in safety circuits, where fire resistance is required. The good screening qualities of the copper braid also reduce radio interference and electrical influences to electronics installations. These cables are fire resistant, flame retardant, low smoke & halogen free.

#### Standards

- DIN 89160/98
- IEC 60092-353
- IEC 60331-21
- IEC 60332-1
- IEC 60332-3-22
- IEC 60754-1/2
- IEC 61034

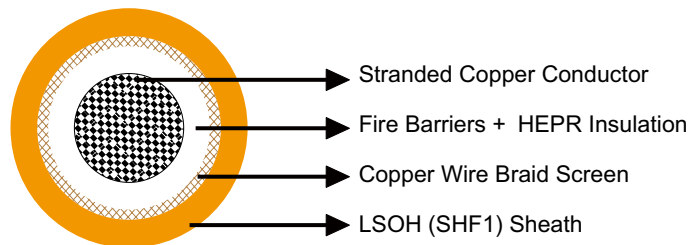

#### Construction

- Conductors: Class 2 stranded copper conductor.
- Insulation: Fire barriers + HEPR.
- Overall Screen: Copper wire braid.
- Outer Sheath: LSOH (SHF1).

#### Core Identification

Single core: Natural colour (beige).



### Mechanical and Thermal Properties

Bending Radius for Fixed Installations:  $6 \times OD$

Temperature Range:  $-20^{\circ}\text{C} \sim +75^{\circ}\text{C}$

### Dimensions and Weight

Part No.	Construction No. of cores $\times$ Cross section ( $\text{mm}^2$ )	Nominal Insulation Thickness mm	Nominal Sheath Thickness mm	Nominal Overall Diameter mm	Nominal Weight kg/km
MFX300-1mG7MZ1-R-1C25	1 $\times$ 25	0.9	1.2	12.5	380
MFX300-1mG7MZ1-R-1C35	1 $\times$ 35	0.9	1.2	13.5	480
MFX300-1mG7MZ1-R-1C50	1 $\times$ 50	1.0	1.3	15.5	670
MFX300-1mG7MZ1-R-1C70	1 $\times$ 70	1.1	1.4	17.5	900
MFX300-1mG7MZ1-R-1C95	1 $\times$ 95	1.1	1.4	19.5	1170
MFX300-1mG7MZ1-R-1C120	1 $\times$ 120	1.6	1.5	21.0	1430





### BFOI (c)/ BFOU (c) (MFX400)

### 0.6/1 kV Fire Barriers + HEPR Insulated, LSOH (SHF1) Sheathed, Screened Fire Resistant Power & Control Cables (Multicore)

#### Application

These cables are used for fixed installations on ships and offshore units in all locations and on open deck in safety circuits, where fire resistance is required. The good screening qualities of the copper braid also reduce radio interference and electrical influences to electronics installations. These cables are fire resistant, flame retardant, low smoke & halogen free.

#### Standards

- DIN 89160/98
- IEC 60092-353
- IEC 60331-21
- IEC 60332-1
- IEC 60332-3-22
- IEC 60754-1/2
- IEC 61034

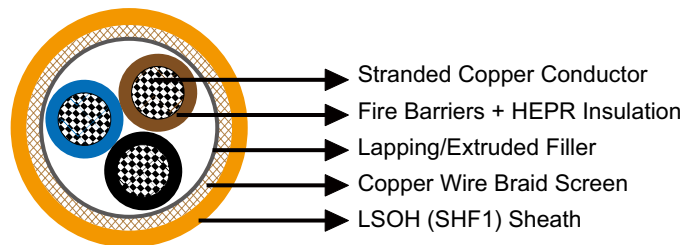

#### Construction

- Conductors: Class 2 stranded copper conductor.
- Insulation: Fire barriers + HEPR.
- Inner Covering: Lapping or extruded filler.
- Overall Screen: Copper wire braid.
- Outer Sheath: LSOH (SHF1).

#### Core Identification

Two cores: Black, Blue.

Three cores: Black, Blue, Brown.

Four cores: Black, Blue, Brown, Black.

Five cores: Black, Blue, Brown, Black, Black.

Multi cores: All cores natural coloured, printed with numbers, starting in center with number 1.

# IEC Standard Caledonian Offshore & Marine Cables

## MariFlex Marine Fire Resistant Power & Control Cables



[www.caledonian-cables.co.uk](http://www.caledonian-cables.co.uk)

Cables with 3 cores and more also with green/yellow core (has to be stated in order).

### Mechanical and Thermal Properties

Bending Radius for Fixed Installations:  $6 \times OD$

Temperature Range:  $-20^{\circ}\text{C} \sim +75^{\circ}\text{C}$

### Dimensions and Weight

Part No.	Construction No. of cores $\times$ Cross section ( $\text{mm}^2$ )	Nominal Insulation Thickness mm	Nominal Sheath Thickness mm	Nominal Overall Diameter mm	Nominal Weight kg/km
MFX400-1mG7MZ1-R-2C1.5	2 $\times$ 1.5	0.7	1.2	12.5	210
MFX400-1mG7MZ1-R-2C2.5	2 $\times$ 2.5	0.7	1.2	13.0	250
MFX400-1mG7MZ1-R-2C4	2 $\times$ 4	0.7	1.3	14.0	300
MFX400-1mG7MZ1-R-2C6	2 $\times$ 6	0.7	1.3	16.0	410
MFX400-1mG7MZ1-R-2C10	2 $\times$ 10	0.7	1.4	18.0	550
MFX400-1mG7MZ1-R-2C16	2 $\times$ 16	0.7	1.5	20.0	720
MFX400-1mG7MZ1-R-2C25	2 $\times$ 25	0.9	1.6	23.5	1050
MFX400-1mG7MZ1-R-3C1.5	3 $\times$ 1.5	0.7	1.2	13.0	230
MFX400-1mG7MZ1-R-3C2.5	3 $\times$ 2.5	0.7	1.2	14.0	280
MFX400-1mG7MZ1-R-3C4	3 $\times$ 4	0.7	1.3	15.0	350
MFX400-1mG7MZ1-R-3C6	3 $\times$ 6	0.7	1.3	16.5	480
MFX400-1mG7MZ1-R-3C10	3 $\times$ 10	0.7	1.4	19.0	670
MFX400-1mG7MZ1-R-3C16	3 $\times$ 16	0.7	1.5	21.0	870
MFX400-1mG7MZ1-R-3C25	3 $\times$ 25	0.9	1.7	24.5	1300
MFX400-1mG7MZ1-R-3C35	3 $\times$ 35	0.9	1.8	27.0	1680
MFX400-1mG7MZ1-R-3C50	3 $\times$ 50	1.0	2.1	30.5	2190
MFX400-1mG7MZ1-R-3C70	3 $\times$ 70	1.1	2.0	35.0	3020
MFX400-1mG7MZ1-R-3C95	3 $\times$ 95	1.1	2.3	39.5	4050
MFX400-1mG7MZ1-R-3C120	3 $\times$ 120	1.2	2.5	44.0	5000
MFX400-1mG7MZ1-R-4C1.5	4 $\times$ 1.5	0.7	1.2	13.5	270
MFX400-1mG7MZ1-R-4C2.5	4 $\times$ 2.5	0.7	1.3	15.0	330
MFX400-1mG7MZ1-R-4C4	4 $\times$ 4	0.7	1.3	16.5	460
MFX400-1mG7MZ1-R-4C6	4 $\times$ 6	0.7	1.4	18.0	560
MFX400-1mG7MZ1-R-4C10	4 $\times$ 10	0.7	1.5	20.5	790
MFX400-1mG7MZ1-R-4C16	4 $\times$ 16	0.7	1.6	23.0	1090
MFX400-1mG7MZ1-R-4C25	4 $\times$ 25	0.9	1.8	27.0	1630
MFX400-1mG7MZ1-R-5C1.5	5 $\times$ 1.5	0.7	1.3	14.5	320
MFX400-1mG7MZ1-R-5C2.5	5 $\times$ 2.5	0.7	1.3	16.5	440
MFX400-1mG7MZ1-R-7C1.5	7 $\times$ 1.5	0.7	1.3	16.5	400
MFX400-1mG7MZ1-R-10C1.5	10 $\times$ 1.5	0.7	1.3	19.5	450
MFX400-1mG7MZ1-R-12C1.5	12 $\times$ 1.5	0.7	1.4	20.0	510
MFX400-1mG7MZ1-R-14C1.5	14 $\times$ 1.5	0.7	1.4	21.0	570
MFX400-1mG7MZ1-R-16C1.5	16 $\times$ 1.5	0.7	1.4	22.0	640
MFX400-1mG7MZ1-R-19C1.5	19 $\times$ 1.5	0.7	1.5	23.5	730
MFX400-1mG7MZ1-R-24C1.5	24 $\times$ 1.5	0.7	1.6	27.0	910



# IEC Standard Caledonian Offshore & Marine Cables

## MariSig Flame Retardant Instrumentation & Control Cables

[www.caledonian-cables.co.uk](http://www.caledonian-cables.co.uk)

### TI/ TU (MRE-2XH)

### 150/250V XLPE Insulated, LSOH (SHF1) Sheathed Flame

### Retardant Instrumentation & Control Cables (Multicore)

---

#### Application

These cables are used on board of ships at all locations for fixed installations not subject to mechanical risk complying with IEC standards 60092-352. These cables are flame retardant, low smoke & halogen free, suitable for installations on passenger ships, as on other commercial vessels.

#### Standards

- IEC 60092-350/360/376
- IEC 60332-1
- IEC 60332-3-22
- IEC 60754-1/2
- IEC 61034

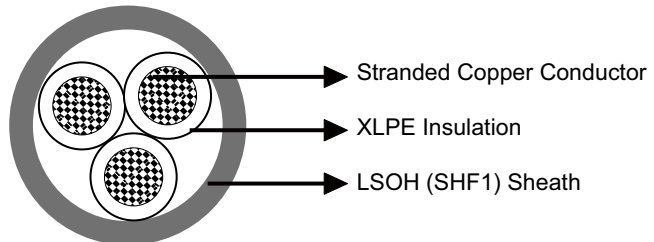

#### Construction

- Conductors: Class 2 stranded copper conductor.
- Insulation: XLPE.
- Outer Sheath: LSOH (SHF1). SHF2 can be offered upon request.

#### Core Identification

White with printed number.

#### Mechanical and Thermal Properties

Bending Radius for Fixed Installations:  $4 \times OD$

Temperature Range:  $-30^{\circ}\text{C} \sim +80^{\circ}\text{C}$

# IEC Standard Caledonian Offshore & Marine Cables

## MariSig Flame Retardant Instrumentation & Control Cables



[www.caledonian-cables.co.uk](http://www.caledonian-cables.co.uk)

### Dimensions and Weight

Part No.	Construction No. of cores×Cross section(mm <sup>2</sup> )	Nominal Insulation Thickness mm	Nominal Sheath Thickness mm	Nominal Overall Diameter mm	Nominal Weight kg/km
MRE-2XH-2C0.75	2×0.75	0.5	1.1	6.2	50
MRE-2XH-3C0.75	3×0.75	0.5	1.1	6.5	60
MRE-2XH-5C0.75	5×0.75	0.5	1.2	7.7	80
MRE-2XH-7C0.75	7×0.75	0.5	1.2	8.3	100
MRE-2XH-12C0.75	12×0.75	0.5	1.3	10.9	170
MRE-2XH-19C0.75	19×0.75	0.5	1.6	13.0	250
MRE-2XH-27C0.75	27×0.75	0.5	1.7	15.6	350
MRE-2XH-37C0.75	37×0.75	0.5	1.9	17.6	470
MRE-2XH-2C1.0	2×1.0	0.5	1.1	6.6	60
MRE-2XH-3C1.0	3×1.0	0.5	1.2	7.0	70
MRE-2XH-5C1.0	5×1.0	0.5	1.2	8.2	100
MRE-2XH-7C1.0	7×1.0	0.5	1.3	9.1	130
MRE-2XH-12C1.0	12×1.0	0.5	1.4	11.7	210
MRE-2XH-19C1.0	19×1.0	0.5	1.7	14.0	310
MRE-2XH-27C1.0	27×1.0	0.5	1.9	16.8	430
MRE-2XH-37C1.0	37×1.0	0.5	2.0	19.0	580





# IEC Standard Caledonian Offshore & Marine Cables

## MariSig Flame Retardant Instrumentation & Control Cables

www.caledonian-cables.co.uk

### TIOI/ TIOU (MRE-2XCH)

### 150/250V XLPE Insulated, LSOH (SHF1) Sheathed, Armoured

### Flame Retardant Instrumentation & Control Cables (Multicore)

#### Application

These armoured cables are used on board of ships in all locations for fixed installations complying with IEC standards 60092-352. These cables are flame retardant, low smoke & halogen free, suitable for installations on passenger ships, as on other commercial vessels.

#### Standards

- IEC 60092-350/360/376
- IEC 60332-1
- IEC 60332-3-22
- IEC 60754-1/2
- IEC 61034

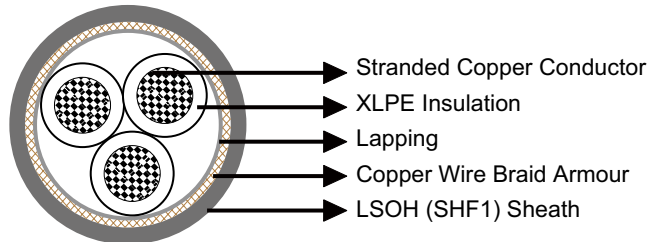

#### Construction

- Conductors: Class 2 stranded copper conductor.
- Insulation: XLPE.
- Inner Covering: Lapping.
- Armour: Copper wire braid.
- Outer Sheath: LSOH (SHF1). SHF2 can be offered upon request.

#### Core Identification

White with printed number.

#### Mechanical and Thermal Properties

Bending Radius for Fixed Installations:  $6 \times OD$   
Temperature Range:  $-30^{\circ}C \sim +80^{\circ}C$



# IEC Standard Caledonian Offshore & Marine Cables

## MariSig Flame Retardant Instrumentation & Control Cables



[www.caledonian-cables.co.uk](http://www.caledonian-cables.co.uk)

### Dimensions and Weight

Part No.	Construction No. of cores×Cross section(mm <sup>2</sup> )	Nominal Insulation Thickness mm	Nominal Sheath Thickness mm	Nominal Overall Diameter mm	Nominal Weight kg/km
MRE-2XCH-2C0.75	2×0.75	0.5	1.2	7.2	80
MRE-2XCH-3C0.75	3×0.75	0.5	1.2	7.5	90
MRE-2XCH-5C0.75	5×0.75	0.5	1.4	8.9	130
MRE-2XCH-7C0.75	7×0.75	0.5	1.6	9.8	150
MRE-2XCH-12C0.75	12×0.75	0.5	1.7	12.4	230
MRE-2XCH-19C0.75	19×0.75	0.5	1.9	14.6	320
MRE-2XCH-27C0.75	27×0.75	0.5	2.1	17.3	460
MRE-2XCH-37C0.75	37×0.75	0.5	2.2	19.3	590
MRE-2XCH-2C1.0	2×1.0	0.5	1.4	7.9	90
MRE-2XCH-3C1.0	3×1.0	0.5	1.4	8.3	100
MRE-2XCH-5C1.0	5×1.0	0.5	1.5	9.7	150
MRE-2XCH-7C1.0	7×1.0	0.5	1.6	10.4	180
MRE-2XCH-12C1.0	12×1.0	0.5	1.8	13.2	270
MRE-2XCH-19C1.0	19×1.0	0.5	2.1	15.9	420
MRE-2XCH-27C1.0	27×1.0	0.5	2.2	18.4	560
MRE-2XCH-37C1.0	37×1.0	0.5	2.4	20.7	710

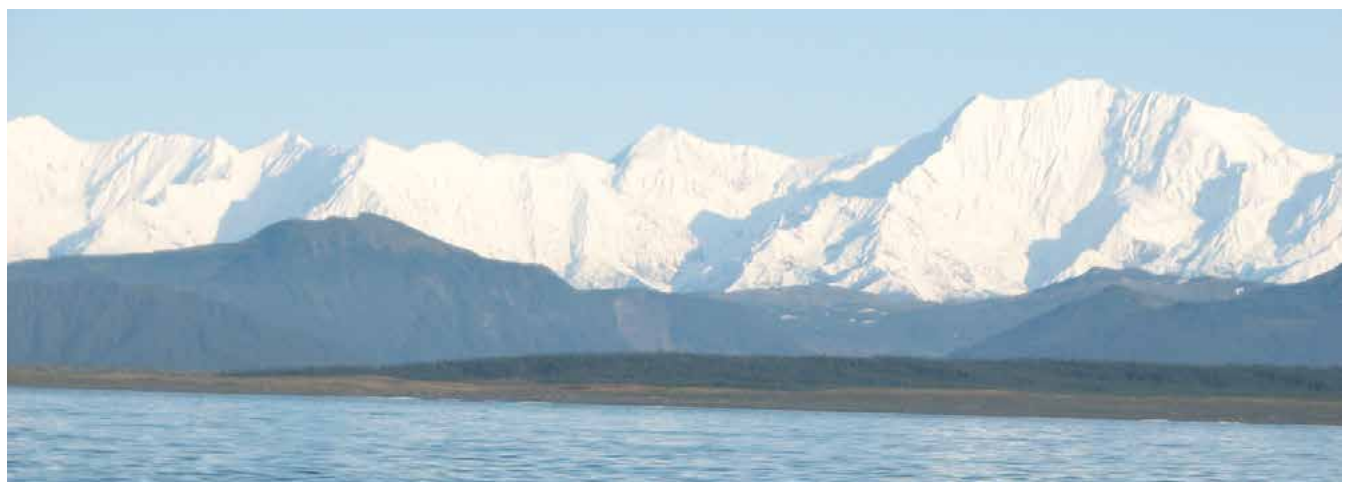



# IEC Standard Caledonian Offshore & Marine Cables

## MariSig Flame Retardant Instrumentation & Control Cables

[www.caledonian-cables.co.uk](http://www.caledonian-cables.co.uk)

### TFOI/ TFOU (MRE-2XCH)

### 150/250V XLPE Insulated, LSOH (SHF1) Sheathed, Armoured Flame Retardant Instrumentation & Control Cables (Multipair/ Multitriples)

---

#### Application

These armoured cables are used on board of ships in all locations for fixed installations complying with IEC standards 60092-352. These cables are flame retardant, low smoke & halogen free, suitable for installations on passenger ships, as on other commercial vessels.

#### Standards

- IEC 60092-350/360/376
- IEC 60332-1
- IEC 60332-3-22
- IEC 60754-1/2
- IEC 61034

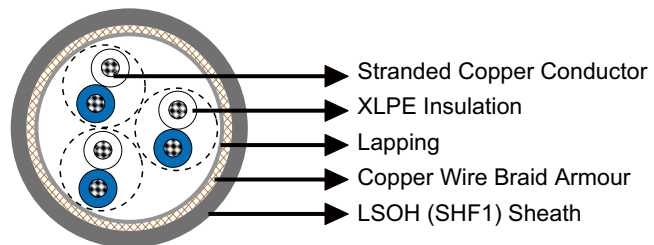

#### Construction

- Conductors: Class 2 stranded copper conductor.
- Insulation: XLPE.
- Cabling Element: Pair/Triple.
- Inner Covering: Lapped polyester tape.
- Armour: Copper wire braid.
- Outer Sheath: LSOH (SHF1). SHF2 can be offered upon request.

#### Core Identification

Pair: White/blue with printed pair number and core number.  
Triple: White/blue/red with printed triple number.



### Mechanical and Thermal Properties

Bending Radius for Fixed Installations:  $6 \times OD$

Temperature Range:  $-30^{\circ}\text{C} \sim +80^{\circ}\text{C}$

### Dimensions and Weight

Part No.	Construction No. of elements×No. of cores in element×Cross section(mm <sup>2</sup> )	Nominal Insulation Thickness mm	Nominal Sheath Thickness mm	Nominal Overall Diameter mm	Nominal Weight kg/km
MRE-2XCH-1P0.75	1×2×0.75	0.5	1.2	8.1	90
MRE-2XCH-2P0.75	2×2×0.75	0.5	1.3	9.3	130
MRE-2XCH-3P0.75	3×2×0.75	0.5	1.4	12.4	200
MRE-2XCH-4P0.75	4×2×0.75	0.5	1.4	13.1	230
MRE-2XCH-5P0.75	5×2×0.75	0.5	1.8	15.2	320
MRE-2XCH-6P0.75	6×2×0.75	0.5	1.8	16.1	350
MRE-2XCH-7P0.75	7×2×0.75	0.5	1.8	16.1	370
MRE-2XCH-8P0.75	8×2×0.75	0.5	1.9	17.2	420
MRE-2XCH-10P0.75	10×2×0.75	0.5	1.9	19.1	500
MRE-2XCH-12P0.75	12×2×0.75	0.5	2.0	20.0	560
MRE-2XCH-14P0.75	14×2×0.75	0.5	2.0	20.6	610
MRE-2XCH-16P0.75	16×2×0.75	0.5	2.1	22.2	690
MRE-2XCH-19P0.75	19×2×0.75	0.5	2.1	23.6	790
MRE-2XCH-20P0.75	20×2×0.75	0.5	2.1	23.6	800
MRE-2XCH-24P0.75	24×2×0.75	0.5	2.2	26.8	980
MRE-2XCH-30P0.75	30×2×0.75	0.5	2.3	29.1	1160
MRE-2XCH-37P0.75	37×2×0.75	0.5	2.4	31.1	1360
MRE-2XCH-1P1.0	1×2×1.0	0.5	1.3	8.7	110
MRE-2XCH-2P1.0	2×2×1.0	0.5	1.3	9.7	150
MRE-2XCH-3P1.0	3×2×1.0	0.5	1.4	13.2	230
MRE-2XCH-4P1.0	4×2×1.0	0.5	1.8	14.6	310
MRE-2XCH-5P1.0	5×2×1.0	0.5	1.8	16.1	360
MRE-2XCH-6P1.0	6×2×1.0	0.5	1.9	17.3	420
MRE-2XCH-7P1.0	7×2×1.0	0.5	1.9	17.3	440
MRE-2XCH-8P1.0	8×2×1.0	0.5	1.9	18.3	490
MRE-2XCH-10P1.0	10×2×1.0	0.5	2.0	20.5	590
MRE-2XCH-12P1.0	12×2×1.0	0.5	2.0	21.3	660
MRE-2XCH-14P1.0	14×2×1.0	0.5	2.1	22.2	730
MRE-2XCH-16P1.0	16×2×1.0	0.5	2.1	23.7	820
MRE-2XCH-19P1.0	19×2×1.0	0.5	2.2	25.4	940





# IEC Standard Caledonian Offshore & Marine Cables

## MariSig Flame Retardant Instrumentation & Control Cables

[www.caledonian-cables.co.uk](http://www.caledonian-cables.co.uk)

Part No.	Construction No. of elements×No. of cores in element×Cross section(mm <sup>2</sup> )	Nominal Insulation Thickness mm	Nominal Sheath Thickness mm	Nominal Overall Diameter mm	Nominal Weight kg/km
MRE-2XCH-20P1.0	20×2×1.0	0.5	2.2	25.4	960
MRE-2XCH-24P1.0	24×2×1.0	0.5	2.3	28.9	1170
MRE-2XCH-30P1.0	30×2×1.0	0.5	2.4	31.3	1400
MRE-2XCH-37P1.0	37×2×1.0	0.5	2.5	33.5	1640
MRE-2XCH-1P1.5	1×2×1.5	0.6	1.3	9.7	140
MRE-2XCH-2P1.5	2×2×1.5	0.6	1.3	10.9	190
MRE-2XCH-3P1.5	3×2×1.5	0.6	1.8	15.7	340
MRE-2XCH-4P1.5	4×2×1.5	0.6	1.9	16.8	400
MRE-2XCH-5P1.5	5×2×1.5	0.6	1.9	18.6	480
MRE-2XCH-6P1.5	6×2×1.5	0.6	2.0	20.0	550
MRE-2XCH-7P1.5	7×2×1.5	0.6	2.0	20.0	590
MRE-2XCH-8P1.5	8×2×1.5	0.6	2.0	21.2	650
MRE-2XCH-10P1.5	10×2×1.5	0.6	2.1	23.8	800
MRE-2XCH-12P1.5	12×2×1.5	0.6	2.2	24.9	900
MRE-2XCH-14P1.5	14×2×1.5	0.6	2.2	25.8	990
MRE-2XCH-16P1.5	16×2×1.5	0.6	2.3	27.8	1130
MRE-2XCH-19P1.5	19×2×1.5	0.6	2.3	29.6	1290
MRE-2XCH-20P1.5	20×2×1.5	0.6	2.3	29.6	1320
MRE-2XCH-24P1.5	24×2×1.5	0.6	2.5	33.9	1630
MRE-2XCH-30P1.5	30×2×1.5	0.6	2.8	37.3	2040
MRE-2XCH-37P1.5	37×2×1.5	0.6	2.9	39.9	2390
MRE-2XCH-1T0.75	1×3×0.75	0.5	1.3	8.7	110
MRE-2XCH-2T0.75	2×3×0.75	0.5	1.4	12.6	210
MRE-2XCH-3T0.75	3×3×0.75	0.5	1.4	13.3	240
MRE-2XCH-4T0.75	4×3×0.75	0.5	1.8	15.2	330
MRE-2XCH-5T0.75	5×3×0.75	0.5	1.9	16.8	400
MRE-2XCH-6T0.75	6×3×0.75	0.5	1.9	18.6	470
MRE-2XCH-7T0.75	7×3×0.75	0.5	1.9	18.6	490
MRE-2XCH-8T0.75	8×3×0.75	0.5	2.0	20.0	560
MRE-2XCH-10T0.75	10×3×0.75	0.5	2.1	22.5	690
MRE-2XCH-12T0.75	12×3×0.75	0.5	2.1	23.6	770
MRE-2XCH-14T0.75	14×3×0.75	0.5	2.1	24.5	850
MRE-2XCH-16T0.75	16×3×0.75	0.5	2.2	26.1	950
MRE-2XCH-19T0.75	19×3×0.75	0.5	2.3	28.2	1100
MRE-2XCH-20T0.75	20×3×0.75	0.5	2.3	28.6	1140
MRE-2XCH-24T0.75	24×3×0.75	0.5	2.4	31.1	1340
MRE-2XCH-30T0.75	30×3×0.75	0.5	2.5	34.3	1620
MRE-2XCH-32T0.75	32×3×0.75	0.5	2.5	35.4	1720
MRE-2XCH-1T1.0	1×3×1.0	0.5	1.3	9.1	130

# IEC Standard Caledonian Offshore & Marine Cables

## MariSig Flame Retardant Instrumentation & Control Cables



[www.caledonian-cables.co.uk](http://www.caledonian-cables.co.uk)

Part No.	Construction No. of elements×No. of cores in element×Cross section(mm <sup>2</sup> )	Nominal Insulation Thickness mm	Nominal Sheath Thickness mm	Nominal Overall Diameter mm	Nominal Weight kg/km
MRE-2XCH-2T1.0	2×3×1.0	0.5	1.4	13.4	240
MRE-2XCH-3T1.0	3×3×1.0	0.5	1.8	14.9	320
MRE-2XCH-4T1.0	4×3×1.0	0.5	1.8	16.1	380
MRE-2XCH-5T1.0	5×3×1.0	0.5	1.9	17.8	460
MRE-2XCH-6T1.0	6×3×1.0	0.5	2.0	20.0	560
MRE-2XCH-7T1.0	7×3×1.0	0.5	2.0	20.0	590
MRE-2XCH-8T1.0	8×3×1.0	0.5	2.0	21.3	660
MRE-2XCH-10T1.0	10×3×1.0	0.5	2.1	24.0	810
MRE-2XCH-12T1.0	12×3×1.0	0.5	2.2	25.4	920
MRE-2XCH-14T1.0	14×3×1.0	0.5	2.2	26.4	1020
MRE-2XCH-16T1.0	16×3×1.0	0.5	2.3	28.1	1150
MRE-2XCH-19T1.0	19×3×1.0	0.5	2.4	30.3	1330
MRE-2XCH-20T1.0	20×3×1.0	0.5	2.4	30.8	1380
MRE-2XCH-24T1.0	24×3×1.0	0.5	2.5	33.5	1620
MRE-2XCH-30T1.0	30×3×1.0	0.5	2.8	37.5	2060
MRE-2XCH-32T1.0	32×3×1.0	0.5	2.9	38.9	2190
MRE-2XCH-1T1.5	1×3×1.5	0.6	1.3	10.2	160
MRE-2XCH-2T1.5	2×3×1.5	0.6	1.8	16.0	350
MRE-2XCH-3T1.5	3×3×1.5	0.6	1.9	17.1	430
MRE-2XCH-4T1.5	4×3×1.5	0.6	1.9	18.6	510
MRE-2XCH-5T1.5	5×3×1.5	0.6	2.0	20.6	620
MRE-2XCH-6T1.5	6×3×1.5	0.6	2.1	23.2	750
MRE-2XCH-7T1.5	7×3×1.5	0.6	2.1	23.2	800
MRE-2XCH-8T1.5	8×3×1.5	0.6	2.2	24.9	900
MRE-2XCH-10T1.5	10×3×1.5	0.6	2.3	28.1	1110
MRE-2XCH-12T1.5	12×3×1.5	0.6	2.3	29.6	1260
MRE-2XCH-14T1.5	14×3×1.5	0.6	2.4	31.0	1410
MRE-2XCH-16T1.5	16×3×1.5	0.6	2.5	33.0	1590
MRE-2XCH-19T1.5	19×3×1.5	0.6	2.5	35.4	1830
MRE-2XCH-20T1.5	20×3×1.5	0.6	2.8	36.7	2010
MRE-2XCH-24T1.5	24×3×1.5	0.6	2.9	39.9	2360
MRE-2XCH-30T1.5	30×3×1.5	0.6	3.1	44.2	2880
MRE-2XCH-32T1.5	32×3×1.5	0.6	3.1	45.7	3060



# IEC Standard Caledonian Offshore & Marine Cables

## MariSig Flame Retardant Instrumentation & Control Cables

[www.caledonian-cables.co.uk](http://www.caledonian-cables.co.uk)

### TIOI (c)/ TIOU(c) (MRE-2X(St)HCH)

150/250V XLPE Insulated, LSOH (SHF1) Sheathed, Overall

### Screened & Armoured Flame Retardant Instrumentation & Control Cables (Multipair/Multitriples)

---

#### Application

These armoured cables are used on board of ships in all locations for fixed installations where cable protection is required. These cables are flame retardant, low smoke & halogen free, suitable for installations on passenger ships, as on other commercial vessels.

#### Standards

- IEC 60092-350/360/376
- IEC 60332-1
- IEC 60332-3-22
- IEC 60754-1/2
- IEC 61034

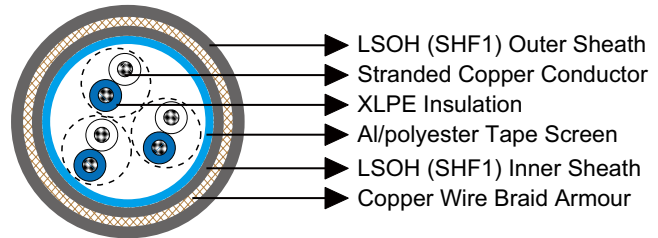

#### Construction

- Conductors: Class 2 stranded copper conductor.
- Insulation: XLPE.
- Cabling Element: Pair/Triple.
- Overall Screen: Al/polyester tape.
- Inner Sheath: LSOH (SHF1).
- Armour: Copper wire braid.
- Outer Sheath: LSOH (SHF1). SHF2 can be offered upon request.

#### Core Identification

Pair: White/blue with printed pair number and core number.

Triple: White/blue/red with printed triple number.



### Mechanical and Thermal Properties

Bending Radius for Fixed Installations:  $6 \times OD$   
 Temperature Range:  $-30^{\circ}\text{C} \sim +80^{\circ}\text{C}$

### Dimensions and Weight

Part No.	Construction No. of elements×No. of cores in element×Cross section(mm <sup>2</sup> )	Nominal Insulation Thickness mm	Nominal Sheath Thickness mm		Nominal Overall Diameter mm	Nominal Weight kg/km
			Inner	Outer		
MRE-2X(St)HCH-1P0.75	1×2×0.75	0.5	1.0	0.8	10.3	150
MRE-2X(St)HCH-2P0.75	2×2×0.75*	0.5	1.0	0.8	11.2	190
MRE-2X(St)HCH-3P0.75	3×2×0.75	0.5	1.1	0.9	14.2	270
MRE-2X(St)HCH-4P0.75	4×2×0.75	0.5	1.2	0.9	15.1	310
MRE-2X(St)HCH-7P0.75	7×2×0.75	0.5	1.2	1.0	17.3	410
MRE-2X(St)HCH-8P0.75	8×2×0.75	0.5	1.3	1.0	18.4	460
MRE-2X(St)HCH-10P0.75	10×2×0.75	0.5	1.4	1.1	20.5	550
MRE-2X(St)HCH-12P0.75	12×2×0.75	0.5	1.4	1.1	21.2	600
MRE-2X(St)HCH-14P0.75	14×2×0.75	0.5	1.4	1.1	21.9	650
MRE-2X(St)HCH-16P0.75	16×2×0.75	0.5	1.5	1.1	23.4	730
MRE-2X(St)HCH-19P0.75	19×2×0.75	0.5	1.5	1.1	24.3	810
MRE-2X(St)HCH-24P0.75	24×2×0.75	0.5	1.6	1.2	27.3	980
MRE-2X(St)HCH-30P0.75	30×2×0.75	0.5	1.7	1.3	30.3	1190
MRE-2X(St)HCH-32P0.75	32×2×0.75	0.5	1.7	1.3	30.8	1240
MRE-2X(St)HCH-37P0.75	37×2×0.75	0.5	1.8	1.3	32.3	1380
MRE-2X(St)HCH-1P1.0	1×2×1.0	0.5	1.0	0.8	10.7	170
MRE-2X(St)HCH-2P1.0	2×2×1.0*	0.5	1.0	0.8	11.7	210
MRE-2X(St)HCH-3P1.0	3×2×1.0	0.5	1.2	0.9	15.2	310
MRE-2X(St)HCH-4P1.0	4×2×1.0	0.5	1.2	0.9	15.9	350
MRE-2X(St)HCH-7P1.0	7×2×1.0	0.5	1.3	1.0	18.5	480
MRE-2X(St)HCH-8P1.0	8×2×1.0	0.5	1.3	1.0	19.5	530
MRE-2X(St)HCH-10P1.0	10×2×1.0	0.5	1.4	1.1	21.8	630
MRE-2X(St)HCH-12P1.0	12×2×1.0	0.5	1.4	1.1	22.5	700
MRE-2X(St)HCH-14P1.0	14×2×1.0	0.5	1.5	1.1	23.4	770
MRE-2X(St)HCH-16P1.0	16×2×1.0	0.5	1.5	1.2	25.1	860
MRE-2X(St)HCH-19P1.0	19×2×1.0	0.5	1.6	1.2	26.2	970
MRE-2X(St)HCH-24P1.0	24×2×1.0	0.5	1.7	1.3	29.5	1190



# IEC Standard Caledonian Offshore & Marine Cables

## MariSig Flame Retardant Instrumentation & Control Cables

[www.caledonian-cables.co.uk](http://www.caledonian-cables.co.uk)

Part No.	Construction No. of elements×No. of cores in element×Cross section(mm <sup>2</sup> )	Nominal Insulation Thickness mm	Nominal Sheath Thickness mm		Nominal Overall Diameter mm	Nominal Weight kg/km
			Inner	Outer		
MRE-2X(St)HCH-30P1.0	30×2×1.0	0.5	1.8	1.3	32.6	1430
MRE-2X(St)HCH-32P1.0	32×2×1.0	0.5	1.8	1.4	33.3	1500
MRE-2X(St)HCH-37P1.0	37×2×1.0	0.5	1.9	1.4	35.3	1750
MRE-2X(St)HCH-1P1.5	1×2×1.5	0.7	1.1	1.2	11.7	200
MRE-2X(St)HCH-2P1.5	2×2×1.5*	0.7	1.1	1.2	13.1	270
MRE-2X(St)HCH-3P1.5	3×2×1.5	0.7	1.2	1.2	17.0	380
MRE-2X(St)HCH-4P1.5	4×2×1.5	0.7	1.3	1.2	18.1	450
MRE-2X(St)HCH-7P1.5	7×2×1.5	0.7	1.4	1.2	21.4	640
MRE-2X(St)HCH-8P1.5	8×2×1.5	0.7	1.4	1.2	22.6	700
MRE-2X(St)HCH-10P1.5	10×2×1.5	0.7	1.5	1.2	25.3	840
MRE-2X(St)HCH-12P1.5	12×2×1.5	0.7	1.6	1.2	26.4	940
MRE-2X(St)HCH-14P1.5	14×2×1.5	0.7	1.6	1.2	27.2	1030
MRE-2X(St)HCH-16P1.5	16×2×1.5	0.7	1.7	1.3	29.4	1170
MRE-2X(St)HCH-19P1.5	19×2×1.5	0.7	1.7	1.3	30.5	1310
MRE-2X(St)HCH-24P1.5	24×2×1.5	0.7	1.9	1.4	35.0	1700
MRE-2X(St)HCH-30P1.5	30×2×1.5	0.7	2.0	1.5	38.9	2050
MRE-2X(St)HCH-32P1.5	32×2×1.5	0.7	2.0	1.5	39.5	2140
MRE-2X(St)HCH-37P1.5	37×2×1.5	0.7	2.1	1.6	41.6	2410
MRE-2X(St)HCH-1T0.75	1×3×0.75	0.5	1.0	0.8	10.6	170
MRE-2X(St)HCH-2T0.75	2×3×0.75	0.5	1.1	0.9	14.4	280
MRE-2X(St)HCH-3T0.75	3×3×0.75	0.5	1.2	0.9	15.2	320
MRE-2X(St)HCH-4T0.75	4×3×0.75	0.5	1.2	1.0	16.3	380
MRE-2X(St)HCH-7T0.75	7×3×0.75	0.5	1.3	1.0	19.6	540
MRE-2X(St)HCH-8T0.75	8×3×0.75	0.5	1.4	1.1	21.1	610
MRE-2X(St)HCH-10T0.75	10×3×0.75	0.5	1.5	1.1	23.5	720
MRE-2X(St)HCH-12T0.75	12×3×0.75	0.5	1.5	1.2	24.7	810
MRE-2X(St)HCH-14T0.75	14×3×0.75	0.5	1.5	1.2	25.6	890
MRE-2X(St)HCH-16T0.75	16×3×0.75	0.5	1.6	1.2	27.1	990
MRE-2X(St)HCH-19T0.75	19×3×0.75	0.5	1.7	1.3	29.3	1150
MRE-2X(St)HCH-24T0.75	24×3×0.75	0.5	1.8	1.3	32.1	1370
MRE-2X(St)HCH-30T0.75	30×3×0.75	0.5	1.9	1.4	35.7	1730
MRE-2X(St)HCH-32T0.75	32×3×0.75	0.5	1.9	1.4	36.8	1820
MRE-2X(St)HCH-37T0.75	37×3×0.75	0.5	2.0	1.5	38.7	2040
MRE-2X(St)HCH-1T1.0	1×3×1.0	0.5	1.0	0.8	11.1	190
MRE-2X(St)HCH-2T1.0	2×3×1.0	0.5	1.2	0.9	15.5	320





Part No.	Construction No. of elements×No. of cores in element×Cross section(mm <sup>2</sup> )	Nominal Insulation Thickness mm	Nominal Sheath Thickness mm		Nominal Overall Diameter mm	Nominal Weight kg/km
			Inner	Outer		
MRE-2X(St)HCH-3T1.0	3×3×1.0	0.5	1.2	1.0	16.2	370
MRE-2X(St)HCH-4T1.0	4×3×1.0	0.5	1.3	1.0	17.6	440
MRE-2X(St)HCH-7T1.0	7×3×1.0	0.5	1.4	1.1	21.4	650
MRE-2X(St)HCH-8T1.0	8×3×1.0	0.5	1.4	1.1	22.6	710
MRE-2X(St)HCH-10T1.0	10×3×1.0	0.5	1.5	1.2	25.4	860
MRE-2X(St)HCH-12T1.0	12×3×1.0	0.5	1.6	1.2	26.8	970
MRE-2X(St)HCH-14T1.0	14×3×1.0	0.5	1.6	1.2	27.8	1070
MRE-2X(St)HCH-16T1.0	16×3×1.0	0.5	1.7	1.3	29.6	1200
MRE-2X(St)HCH-19T1.0	19×3×1.0	0.5	1.8	1.3	31.8	1380
MRE-2X(St)HCH-24T1.0	24×3×1.0	0.5	1.9	1.4	35.4	1750
MRE-2X(St)HCH-30T1.0	30×3×1.0	0.5	2.0	1.5	39.0	2100
MRE-2X(St)HCH-32T1.0	32×3×1.0	0.5	2.0	1.5	40.2	2210
MRE-2X(St)HCH-37T1.0	37×3×1.0	0.5	2.1	1.6	42.3	2490
MRE-2X(St)HCH-1T1.5	1×3×1.5	0.7	1.1	1.2	12.3	230
MRE-2X(St)HCH-2T1.5	2×3×1.5	0.7	1.2	1.2	17.2	390
MRE-2X(St)HCH-3T1.5	3×3×1.5	0.7	1.3	1.2	18.3	470
MRE-2X(St)HCH-4T1.5	4×3×1.5	0.7	1.3	1.2	19.7	560
MRE-2X(St)HCH-7T1.5	7×3×1.5	0.7	1.5	1.2	24.6	860
MRE-2X(St)HCH-8T1.5	8×3×1.5	0.7	1.6	1.2	26.2	960
MRE-2X(St)HCH-10T1.5	10×3×1.5	0.7	1.7	1.3	29.5	1150
MRE-2X(St)HCH-12T1.5	12×3×1.5	0.7	1.7	1.3	30.9	1290
MRE-2X(St)HCH-14T1.5	14×3×1.5	0.7	1.8	1.3	32.3	1450
MRE-2X(St)HCH-16T1.5	16×3×1.5	0.7	1.8	1.4	34.2	1620
MRE-2X(St)HCH-19T1.5	19×3×1.5	0.7	1.9	1.5	37.3	1950
MRE-2X(St)HCH-24T1.5	24×3×1.5	0.7	2.1	1.5	41.1	2370
MRE-2X(St)HCH-30T1.5	30×3×1.5	0.7	2.2	1.6	45.3	2860
MRE-2X(St)HCH-32T1.5	32×3×1.5	0.7	2.3	1.7	47.1	3060
MRE-2X(St)HCH-37T1.5	37×3×1.5	0.7	2.4	1.7	49.3	3420

\*: 2 pairs are assembled as a quad.



# IEC Standard Caledonian Offshore & Marine Cables

## MariSig Flame Retardant Instrumentation & Control Cables

www.caledonian-cables.co.uk

### TI (c)/ TU(c) (MRE-2X(St)H)

### 150/250V XLPE Insulated, LSOH (SHF1) Sheathed, Overall Screened Flame Retardant Instrumentation & Control Cables (Multipair/Multitriples)

---

#### Application

These cables are used on board of ships at all locations for fixed installations not subject to mechanical risk complying with IEC standards 60092-352. These cables are flame retardant, low smoke & halogen free, suitable for installations on passenger ships, as on other commercial vessels.

#### Standards

- IEC 60092-350/360/376
- IEC 60332-1
- IEC 60332-3-22
- IEC 60754-1/2
- IEC 61034

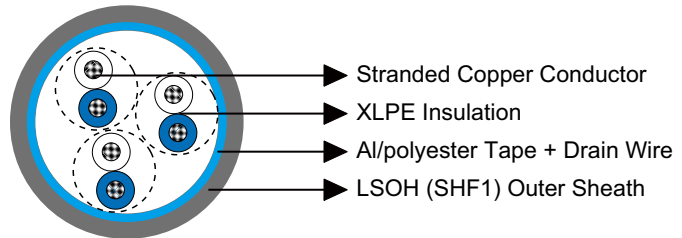

#### Construction

- Conductors: Class 2 stranded copper conductor.
- Insulation: XLPE.
- Cabling Element: Pair/Triple.
- Overall Screen: Al/polyester tape.
- Drain Wire: Tinned copper wire.
- Outer Sheath: LSOH (SHF1). SHF2 can be offered upon request.

#### Core Identification

Pair: White/blue with printed pair number and core number.  
Triple: White/blue/red with printed triple number.



### Mechanical and Thermal Properties

Bending Radius for Fixed Installations:  $6 \times OD$   
 Temperature Range:  $-30^{\circ}\text{C} \sim +80^{\circ}\text{C}$

### Dimensions and Weight

Part No.	Construction No. of elements×No. of cores in element×Cross section(mm <sup>2</sup> )	Nominal Insulation Thickness mm	Nominal Sheath Thickness mm	Nominal Overall Diameter mm	Nominal Weight kg/km
MRE-2X(St)H-2P0.5	2×2×0.5	0.4	1.0	8.5	75
MRE-2X(St)H-4P0.5	4×2×0.5	0.4	1.1	10.0	110
MRE-2X(St)H-7P0.5	7×2×0.5	0.4	1.1	12.0	160
MRE-2X(St)H-10P0.5	10×2×0.5	0.4	1.2	15.0	225
MRE-2X(St)H-14P0.5	14×2×0.5	0.4	1.3	16.5	290
MRE-2X(St)H-19P0.5	19×2×0.5	0.4	1.3	18.0	370
MRE-2X(St)H-24P0.5	24×2×0.5	0.4	1.4	20.5	460
MRE-2X(St)H-1P0.75	1×2×0.75	0.5	1.0	6.9	60
MRE-2X(St)H-2P0.75	2×2×0.75*	0.5	1.0	7.8	80
MRE-2X(St)H-3P0.75	3×2×0.75	0.5	1.1	10.8	130
MRE-2X(St)H-4P0.75	4×2×0.75	0.5	1.2	11.7	160
MRE-2X(St)H-7P0.75	7×2×0.75	0.5	1.3	14.1	240
MRE-2X(St)H-8P0.75	8×2×0.75	0.5	1.3	15.0	270
MRE-2X(St)H-10P0.75	10×2×0.75	0.5	1.4	16.9	320
MRE-2X(St)H-12P0.75	12×2×0.75	0.5	1.4	17.6	360
MRE-2X(St)H-14P0.75	14×2×0.75	0.5	1.4	18.3	410
MRE-2X(St)H-16P0.75	16×2×0.75	0.5	1.5	19.8	470
MRE-2X(St)H-19P0.75	19×2×0.75	0.5	1.5	20.7	530
MRE-2X(St)H-24P0.75	24×2×0.75	0.5	1.6	23.5	670
MRE-2X(St)H-30P0.75	30×2×0.75	0.5	1.7	26.3	820
MRE-2X(St)H-32P0.75	32×2×0.75	0.5	1.7	26.8	860
MRE-2X(St)H-37P0.75	37×2×0.75	0.5	1.8	28.3	990
MRE-2X(St)H-1P1.0	1×2×1.0	0.5	1.0	7.3	70
MRE-2X(St)H-2P1.0	2×2×1.0*	0.5	1.0	8.3	100
MRE-2X(St)H-3P1.0	3×2×1.0	0.5	1.2	11.8	160
MRE-2X(St)H-4P1.0	4×2×1.0	0.5	1.2	12.5	190
MRE-2X(St)H-7P1.0	7×2×1.0	0.5	1.3	15.1	290
MRE-2X(St)H-8P1.0	8×2×1.0	0.5	1.3	16.1	320
MRE-2X(St)H-10P1.0	10×2×1.0	0.5	1.4	18.2	390
MRE-2X(St)H-12P1.0	12×2×1.0	0.5	1.4	18.9	450



# IEC Standard Caledonian Offshore & Marine Cables

## MariSig Flame Retardant Instrumentation & Control Cables

[www.caledonian-cables.co.uk](http://www.caledonian-cables.co.uk)

Part No.	Construction No. of elements×No. of cores in element×Cross section(mm <sup>2</sup> )	Nominal Insulation Thickness mm	Nominal Sheath Thickness mm	Nominal Overall Diameter mm	Nominal Weight kg/km
MRE-2X(St)H-14P1.0	14×2×1.0	0.5	1.5	19.8	510
MRE-2X(St)H-16P1.0	16×2×1.0	0.5	1.5	21.3	570
MRE-2X(St)H-19P1.0	19×2×1.0	0.5	1.6	22.4	670
MRE-2X(St)H-24P1.0	24×2×1.0	0.5	1.7	25.5	830
MRE-2X(St)H-30P1.0	30×2×1.0	0.5	1.8	28.6	1030
MRE-2X(St)H-32P1.0	32×2×1.0	0.5	1.8	29.1	1080
MRE-2X(St)H-37P1.0	37×2×1.0	0.5	1.9	30.7	1230
MRE-2X(St)H-1P1.5	1×2×1.5	0.6	1.0	8.3	90
MRE-2X(St)H-2P1.5	2×2×1.5*	0.6	1.1	9.7	140
MRE-2X(St)H-3P1.5	3×2×1.5	0.6	1.2	13.6	210
MRE-2X(St)H-4P1.5	4×2×1.5	0.6	1.3	14.7	260
MRE-2X(St)H-7P1.5	7×2×1.5	0.6	1.4	17.8	400
MRE-2X(St)H-8P1.5	8×2×1.5	0.6	1.4	19.0	450
MRE-2X(St)H-10P1.5	10×2×1.5	0.6	1.5	21.5	540
MRE-2X(St)H-12P1.5	12×2×1.5	0.6	1.6	22.6	630
MRE-2X(St)H-14P1.5	14×2×1.5	0.6	1.6	23.4	710
MRE-2X(St)H-16P1.5	16×2×1.5	0.6	1.7	25.4	820
MRE-2X(St)H-19P1.5	19×2×1.5	0.6	1.7	26.5	930
MRE-2X(St)H-24P1.5	24×2×1.5	0.6	1.9	30.4	1180
MRE-2X(St)H-30P1.5	30×2×1.5	0.6	2.0	34.1	1460
MRE-2X(St)H-32P1.5	32×2×1.5	0.6	2.0	34.7	1540
MRE-2X(St)H-37P1.5	37×2×1.5	0.6	2.1	36.6	1760
MRE-2X(St)H-1T0.75	1×3×0.75	0.5	1.0	7.2	70
MRE-2X(St)H-2T0.75	2×3×0.75	0.5	1.1	11.0	130
MRE-2X(St)H-3T0.75	3×3×0.75	0.5	1.2	11.8	170
MRE-2X(St)H-4T0.75	4×3×0.75	0.5	1.2	12.9	210
MRE-2X(St)H-7T0.75	7×3×0.75	0.5	1.3	16.2	330
MRE-2X(St)H-8T0.75	8×3×0.75	0.5	1.4	17.5	380
MRE-2X(St)H-10T0.75	10×3×0.75	0.5	1.5	19.9	460
MRE-2X(St)H-12T0.75	12×3×0.75	0.5	1.5	20.9	520
MRE-2X(St)H-14T0.75	14×3×0.75	0.5	1.5	21.8	590
MRE-2X(St)H-16T0.75	16×3×0.75	0.5	1.6	23.3	670
MRE-2X(St)H-19T0.75	19×3×0.75	0.5	1.7	25.3	790
MRE-2X(St)H-24T0.75	24×3×0.75	0.5	1.8	28.1	980
MRE-2X(St)H-30T0.75	30×3×0.75	0.5	1.9	31.1	1200
MRE-2X(St)H-32T0.75	32×3×0.75	0.5	1.9	32.2	1270
MRE-2X(St)H-37T0.75	37×3×0.75	0.5	2.0	33.9	1450
MRE-2X(St)H-1T1.0	1×3×1.0	0.5	1.0	7.7	80
MRE-2X(St)H-2T1.0	2×3×1.0	0.5	1.2	12.1	160



Part No.	Construction No. of elements×No. of cores in element×Cross section(mm <sup>2</sup> )	Nominal Insulation Thickness mm	Nominal Sheath Thickness mm	Nominal Overall Diameter mm	Nominal Weight kg/km
MRE-2X(St)H-3T1.0	3×3×1.0	0.5	1.2	12.8	200
MRE-2X(St)H-4T1.0	4×3×1.0	0.5	1.3	14.2	260
MRE-2X(St)H-7T1.0	7×3×1.0	0.5	1.4	17.8	410
MRE-2X(St)H-8T1.0	8×3×1.0	0.5	1.4	19.0	460
MRE-2X(St)H-10T1.0	10×3×1.0	0.5	1.5	21.6	560
MRE-2X(St)H-12T1.0	12×3×1.0	0.5	1.6	23.0	660
MRE-2X(St)H-14T1.0	14×3×1.0	0.5	1.6	24.0	740
MRE-2X(St)H-16T1.0	16×3×1.0	0.5	1.7	25.6	840
MRE-2X(St)H-19T1.0	19×3×1.0	0.5	1.8	27.8	990
MRE-2X(St)H-24T1.0	24×3×1.0	0.5	1.9	30.8	1230
MRE-2X(St)H-30T1.0	30×3×1.0	0.5	2.0	34.2	1510
MRE-2X(St)H-32T1.0	32×3×1.0	0.5	2.0	35.4	1600
MRE-2X(St)H-37T1.0	37×3×1.0	0.5	2.1	37.3	1830
MRE-2X(St)H-1T1.5	1×3×1.5	0.6	1.1	8.9	110
MRE-2X(St)H-2T1.5	2×3×1.5	0.6	1.2	13.8	210
MRE-2X(St)H-3T1.5	3×3×1.5	0.6	1.3	14.9	280
MRE-2X(St)H-4T1.5	4×3×1.5	0.6	1.3	16.3	350
MRE-2X(St)H-7T1.5	7×3×1.5	0.6	1.5	20.8	570
MRE-2X(St)H-8T1.5	8×3×1.5	0.6	1.6	22.4	660
MRE-2X(St)H-10T1.5	10×3×1.5	0.6	1.7	25.5	790
MRE-2X(St)H-12T1.5	12×3×1.5	0.6	1.7	26.9	920
MRE-2X(St)H-14T1.5	14×3×1.5	0.6	1.8	28.3	1050
MRE-2X(St)H-16T1.5	16×3×1.5	0.6	1.8	30.0	1180
MRE-2X(St)H-19T1.5	19×3×1.5	0.6	1.9	32.5	1390
MRE-2X(St)H-24T1.5	24×3×1.5	0.6	2.1	36.3	1740
MRE-2X(St)H-30T1.5	30×3×1.5	0.6	2.2	40.3	2150
MRE-2X(St)H-32T1.5	32×3×1.5	0.6	2.3	41.9	2300
MRE-2X(St)H-37T1.5	37×3×1.5	0.6	2.4	44.1	2620

\*: 2 pairs are assembled as a quad.





# IEC Standard Caledonian Offshore & Marine Cables

## MariSig Flame Retardant Instrumentation & Control Cables

www.caledonian-cables.co.uk

### TI (i)/ TU(i) (MRE-2XH PiMF/TiMF)

## 150/250V XLPE Insulated, LSOH (SHF1) Sheathed, Individual Screened Flame Retardant Instrumentation & Control Cables (Multipair/Multitriples)

### Application

These cables are used on board of ships at all locations for fixed installations not subject to mechanical risk complying with IEC standards 60092-352. These cables are flame retardant, low smoke & halogen free, suitable for installations on passenger ships, as on other commercial vessels.

### Standards

- IEC 60092-350/360/376
- IEC 60332-1
- IEC 60332-3-22
- IEC 60754-1/2
- IEC 61034

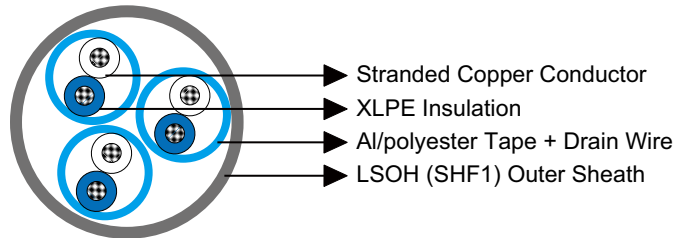

### Construction

- Conductors: Class 2 stranded copper conductor.
- Insulation: XLPE.
- Cabling Element: Pair/Triple.
- Individual Screen: Al/polyester tape.
- Drain Wire: Tinned copper wire.
- Outer Sheath: LSOH (SHF1). SHF2 can be offered upon request.

### Core Identification

Pair: White/blue with printed pair number and core number.  
Triple: White/blue/red with printed triple number.



### Mechanical and Thermal Properties

Bending Radius for Fixed Installations:  $4 \times OD$   
 Temperature Range:  $-30^{\circ}\text{C} \sim +80^{\circ}\text{C}$

### Dimensions and Weight

Part No.	Construction No. of elements×No. of cores in element×Cross section(mm <sup>2</sup> )	Nominal Insulation Thickness mm	Nominal Sheath Thickness mm	Nominal Overall Diameter mm	Nominal Weight kg/km
MRE-2XH PiMF-1P0.75	1×2×0.75	0.5	1.0	7.1	70
MRE-2XH PiMF-2P0.75	2×2×0.75	0.5	1.1	10.8	140
MRE-2XH PiMF-3P0.75	3×2×0.75	0.5	1.2	11.8	180
MRE-2XH PiMF-4P0.75	4×2×0.75	0.5	1.2	12.5	210
MRE-2XH PiMF-5P0.75	5×2×0.75	0.5	1.3	14.2	260
MRE-2XH PiMF-6P0.75	6×2×0.75	0.5	1.3	15.2	300
MRE-2XH PiMF-7P0.75	7×2×0.75	0.5	1.3	15.2	330
MRE-2XH PiMF-8P0.75	8×2×0.75	0.5	1.3	16.1	370
MRE-2XH PiMF-10P0.75	10×2×0.75	0.5	1.4	18.3	460
MRE-2XH PiMF-12P0.75	12×2×0.75	0.5	1.4	19.0	520
MRE-2XH PiMF-14P0.75	14×2×0.75	0.5	1.5	20.0	600
MRE-2XH PiMF-16P0.75	16×2×0.75	0.5	1.5	21.4	670
MRE-2XH PiMF-19P0.75	19×2×0.75	0.5	1.6	23.1	790
MRE-2XH PiMF-20P0.75	20×2×0.75	0.5	1.6	23.1	810
MRE-2XH PiMF-24P0.75	24×2×0.75	0.5	1.7	26.5	1000
MRE-2XH PiMF-30P0.75	30×2×0.75	0.5	1.8	28.9	1220
MRE-2XH PiMF-37P0.75	37×2×0.75	0.5	1.9	31.1	1470
MRE-2XH PiMF-1P1.0	1×2×1.0	0.5	1.0	7.5	80
MRE-2XH PiMF-2P1.0	2×2×1.0	0.5	1.2	11.7	170
MRE-2XH PiMF-3P1.0	3×2×1.0	0.5	1.2	12.5	210
MRE-2XH PiMF-4P1.0	4×2×1.0	0.5	1.2	13.3	250
MRE-2XH PiMF-5P1.0	5×2×1.0	0.5	1.3	15.1	310
MRE-2XH PiMF-6P1.0	6×2×1.0	0.5	1.3	16.2	360
MRE-2XH PiMF-7P1.0	7×2×1.0	0.5	1.3	16.2	400
MRE-2XH PiMF-8P1.0	8×2×1.0	0.5	1.4	17.4	450
MRE-2XH PiMF-10P1.0	10×2×1.0	0.5	1.5	19.7	570
MRE-2XH PiMF-12P1.0	12×2×1.0	0.5	1.5	20.5	650
MRE-2XH PiMF-14P1.0	14×2×1.0	0.5	1.5	21.3	730
MRE-2XH PiMF-16P1.0	16×2×1.0	0.5	1.6	23.1	840
MRE-2XH PiMF-19P1.0	19×2×1.0	0.5	1.7	24.9	980





# IEC Standard Caledonian Offshore & Marine Cables

## MariSig Flame Retardant Instrumentation & Control Cables

[www.caledonian-cables.co.uk](http://www.caledonian-cables.co.uk)

Part No.	Construction No. of elements×No. of cores in element×Cross section(mm <sup>2</sup> )	Nominal Insulation Thickness mm	Nominal Sheath Thickness mm	Nominal Overall Diameter mm	Nominal Weight kg/km
MRE-2XH PiMF-20P1.0	20×2×1.0	0.5	1.7	24.9	1020
MRE-2XH PiMF-24P1.0	24×2×1.0	0.5	1.8	28.5	1250
MRE-2XH PiMF-30P1.0	30×2×1.0	0.5	1.9	31.1	1520
MRE-2XH PiMF-37P1.0	37×2×1.0	0.5	2.0	33.5	1830
MRE-2XH TiMF-1T0.75	1×3×0.75	0.5	1.0	7.5	80
MRE-2XH TiMF-2T0.75	2×3×0.75	0.5	1.2	12.0	170
MRE-2XH TiMF-3T0.75	3×3×0.75	0.5	1.2	12.7	210
MRE-2XH TiMF-4T0.75	4×3×0.75	0.5	1.3	14.1	270
MRE-2XH TiMF-5T0.75	5×3×0.75	0.5	1.3	15.6	330
MRE-2XH TiMF-6T0.75	6×3×0.75	0.5	1.4	17.7	400
MRE-2XH TiMF-7T0.75	7×3×0.75	0.5	1.4	17.7	430
MRE-2XH TiMF-8T0.75	8×3×0.75	0.5	1.4	19.0	490
MRE-2XH TiMF-10T0.75	10×3×0.75	0.5	1.5	21.6	620
MRE-2XH TiMF-12T0.75	12×3×0.75	0.5	1.6	23.0	720
MRE-2XH TiMF-14T0.75	14×3×0.75	0.5	1.6	24.0	810
MRE-2XH TiMF-16T0.75	16×3×0.75	0.5	1.7	25.7	920
MRE-2XH TiMF-19T0.75	19×3×0.75	0.5	1.8	27.8	1090
MRE-2XH TiMF-20T0.75	20×3×0.75	0.5	1.8	28.3	1130
MRE-2XH TiMF-24T0.75	24×3×0.75	0.5	1.9	30.9	1350
MRE-2XH TiMF-30T0.75	30×3×0.75	0.5	2.0	34.3	1660
MRE-2XH TiMF-32T0.75	32×3×0.75	0.5	2.1	35.7	1790
MRE-2XH TiMF-1T1.0	1×3×1.0	0.5	1.0	7.9	100
MRE-2XH TiMF-2T1.0	2×3×1.0	0.5	1.2	12.7	200
MRE-2XH TiMF-3T1.0	3×3×1.0	0.5	1.2	13.5	260
MRE-2XH TiMF-4T1.0	4×3×1.0	0.5	1.3	15.0	330
MRE-2XH TiMF-5T1.0	5×3×1.0	0.5	1.4	16.8	400
MRE-2XH TiMF-6T1.0	6×3×1.0	0.5	1.4	18.9	490
MRE-2XH TiMF-7T1.0	7×3×1.0	0.5	1.4	18.9	530
MRE-2XH TiMF-8T1.0	8×3×1.0	0.5	1.5	20.5	610
MRE-2XH TiMF-10T1.0	10×3×1.0	0.5	1.6	23.3	760
MRE-2XH TiMF-12T1.0	12×3×1.0	0.5	1.6	24.6	880
MRE-2XH TiMF-14T1.0	14×3×1.0	0.5	1.7	25.9	1010
MRE-2XH TiMF-16T1.0	16×3×1.0	0.5	1.8	27.7	1150
MRE-2XH TiMF-19T1.0	19×3×1.0	0.5	1.8	29.8	1340
MRE-2XH TiMF-20T1.0	20×3×1.0	0.5	1.9	30.5	1410
MRE-2XH TiMF-24T1.0	24×3×1.0	0.5	2.0	33.3	1680
MRE-2XH TiMF-30T1.0	30×3×1.0	0.5	2.1	37.0	2070
MRE-2XH TiMF-32T1.0	32×3×1.0	0.5	2.2	38.5	2220





### TFOI (i) /TFOU (i) (MRE-2XCH PiMF/TiMF)

## 150/250V XLPE Insulated, LSOH (SHF1) Sheathed, Individual Screened & Armoured Flame Retardant Instrumentation & Control Cables (Multipair/Multitriple)

### Application

These cables are used on board of ships at all locations for fixed installations complying with IEC standards 60092-352. These cables are flame retardant, low smoke & halogen free, suitable for installations on passenger ships, as on other commercial vessels.

### Standards

- IEC 60092-350/360/376
- IEC 60332-1
- IEC 60332-3-22
- IEC 60754-1/2
- IEC 61034

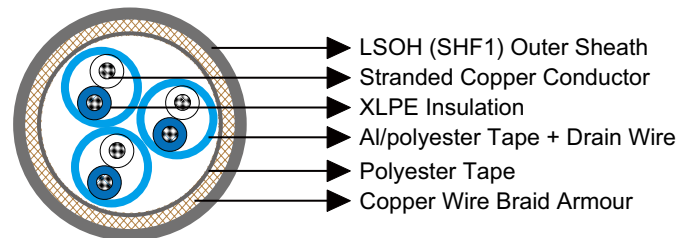

### Construction

- Conductors: Class 2 stranded copper conductor.
- Insulation: XLPE.
- Cabling Element: Pair/Triple.
- Individual Screen: Al/polyester tape.
- Drain Wire: Tinned copper wire.
- Inner Covering: Lapped polyester tape.
- Armour: Copper wire braid.
- Outer Sheath: LSOH (SHF1). SHF2 can be offered upon request.

### Core Identification

Pair: White/blue with printed pair number and core number.  
Triple: White/blue/red with printed triple number.



# IEC Standard Caledonian Offshore & Marine Cables

## MariSig Flame Retardant Instrumentation & Control Cables

www.caledonian-cables.co.uk

### Mechanical and Thermal Properties

Bending Radius for Fixed Installations:  $6 \times OD$   
 Temperature Range:  $-30^{\circ}\text{C} \sim +80^{\circ}\text{C}$

### Dimensions and Weight

Part No.	Construction No. of elements×No. of cores in element×Cross section(mm <sup>2</sup> )	Nominal Insulation Thickness mm	Nominal Sheath Thickness mm	Nominal Overall Diameter mm	Nominal Weight kg/km
MRE-2XCH PiMF-1P0.75	1×2×0.75	0.5	1.2	8.3	110
MRE-2XCH PiMF-2P0.75	2×2×0.75	0.5	1.4	12.2	200
MRE-2XCH PiMF-3P0.75	3×2×0.75	0.5	1.4	13.0	240
MRE-2XCH PiMF-4P0.75	4×2×0.75	0.5	1.7	14.4	310
MRE-2XCH PiMF-5P0.75	5×2×0.75	0.5	1.7	15.9	370
MRE-2XCH PiMF-6P0.75	6×2×0.75	0.5	1.9	17.1	430
MRE-2XCH PiMF-7P0.75	7×2×0.75	0.5	1.9	17.1	450
MRE-2XCH PiMF-8P0.75	8×2×0.75	0.5	1.9	18.0	500
MRE-2XCH PiMF-10P0.75	10×2×0.75	0.5	2.0	20.2	610
MRE-2XCH PiMF-12P0.75	12×2×0.75	0.5	2.0	20.9	680
MRE-2XCH PiMF-14P0.75	14×2×0.75	0.5	2.0	21.7	750
MRE-2XCH PiMF-16P0.75	16×2×0.75	0.5	2.1	23.3	850
MRE-2XCH PiMF-19P0.75	19×2×0.75	0.5	2.2	25.0	980
MRE-2XCH PiMF-20P0.75	20×2×0.75	0.5	2.2	25.0	1010
MRE-2XCH PiMF-24P0.75	24×2×0.75	0.5	2.3	28.4	1220
MRE-2XCH PiMF-30P0.75	30×2×0.75	0.5	2.4	30.8	1460
MRE-2XCH PiMF-37P0.75	37×2×0.75	0.5	2.5	33.0	1720
MRE-2XCH PiMF-1P1.0	1×2×1.0	0.5	1.3	8.9	120
MRE-2XCH PiMF-2P1.0	2×2×1.0	0.5	1.4	12.9	230
MRE-2XCH PiMF-3P1.0	3×2×1.0	0.5	1.8	14.4	310
MRE-2XCH PiMF-4P1.0	4×2×1.0	0.5	1.8	15.2	360
MRE-2XCH PiMF-5P1.0	5×2×1.0	0.5	1.8	17.0	440
MRE-2XCH PiMF-6P1.0	6×2×1.0	0.5	1.8	18.1	500
MRE-2XCH PiMF-7P1.0	7×2×1.0	0.5	1.8	18.1	530
MRE-2XCH PiMF-8P1.0	8×2×1.0	0.5	1.8	19.1	590
MRE-2XCH PiMF-10P1.0	10×2×1.0	0.5	2.0	21.4	720
MRE-2XCH PiMF-12P1.0	12×2×1.0	0.5	2.1	22.4	820
MRE-2XCH PiMF-14P1.0	14×2×1.0	0.5	2.1	23.2	900
MRE-2XCH PiMF-16P1.0	16×2×1.0	0.5	2.2	25.0	1030
MRE-2XCH PiMF-19P1.0	19×2×1.0	0.5	2.2	26.6	1180

# IEC Standard Caledonian Offshore & Marine Cables

## MariSig Flame Retardant Instrumentation & Control Cables



[www.caledonian-cables.co.uk](http://www.caledonian-cables.co.uk)

Part No.	Construction No. of elements×No. of cores in element×Cross section(mm <sup>2</sup> )	Nominal Insulation Thickness mm	Nominal Sheath Thickness mm	Nominal Overall Diameter mm	Nominal Weight kg/km
MRE-2XCH PiMF-20P1.0	20×2×1.0	0.5	2.2	26.6	1210
MRE-2XCH PiMF-24P1.0	24×2×1.0	0.5	2.4	30.4	1480
MRE-2XCH PiMF-30P1.0	30×2×1.0	0.5	2.5	33.0	1780
MRE-2XCH PiMF-37P1.0	37×2×1.0	0.5	2.5	35.2	2090
MRE-2XCH PiMF-1P1.5	1×2×1.5	0.6	1.3	9.9	150
MRE-2XCH PiMF-2P1.5	2×2×1.5	0.6	1.8	15.3	320
MRE-2XCH PiMF-3P1.5	3×2×1.5	0.6	1.8	16.3	390
MRE-2XCH PiMF-4P1.5	4×2×1.5	0.6	1.8	17.4	460
MRE-2XCH PiMF-5P1.5	5×2×1.5	0.6	1.8	19.5	560
MRE-2XCH PiMF-6P1.5	6×2×1.5	0.6	2.0	20.8	640
MRE-2XCH PiMF-7P1.5	7×2×1.5	0.6	2.0	20.8	690
MRE-2XCH PiMF-8P1.5	8×2×1.5	0.6	2.1	22.2	770
MRE-2XCH PiMF-10P1.5	10×2×1.5	0.6	2.2	24.9	950
MRE-2XCH PiMF-12P1.5	12×2×1.5	0.6	2.2	25.9	1070
MRE-2XCH PiMF-14P1.5	14×2×1.5	0.6	2.2	26.8	1180
MRE-2XCH PiMF-16P1.5	16×2×1.5	0.6	2.3	28.9	1350
MRE-2XCH PiMF-19P1.5	19×2×1.5	0.6	2.4	31.0	1560
MRE-2XCH PiMF-20P1.5	20×2×1.5	0.6	2.4	31.0	1600
MRE-2XCH PiMF-24P1.5	24×2×1.5	0.6	2.5	35.3	1950
MRE-2XCH PiMF-30P1.5	30×2×1.5	0.6	2.9	39.0	2450
MRE-2XCH PiMF-37P1.5	37×2×1.5	0.6	3.0	41.8	2900
MRE-2XCH TiMF-1T0.75	1×3×0.75	0.5	1.3	8.9	120
MRE-2XCH TiMF-2T0.75	2×3×0.75	0.5	1.4	13.2	230
MRE-2XCH TiMF-3T0.75	3×3×0.75	0.5	1.8	14.6	320
MRE-2XCH TiMF-4T0.75	4×3×0.75	0.5	1.8	15.8	380
MRE-2XCH TiMF-5T0.75	5×3×0.75	0.5	1.8	17.5	460
MRE-2XCH TiMF-6T0.75	6×3×0.75	0.5	2.0	19.6	550
MRE-2XCH TiMF-7T0.75	7×3×0.75	0.5	2.0	19.6	580
MRE-2XCH TiMF-8T0.75	8×3×0.75	0.5	2.0	20.9	650
MRE-2XCH TiMF-10T0.75	10×3×0.75	0.5	2.1	23.5	800
MRE-2XCH TiMF-12T0.75	12×3×0.75	0.5	2.2	24.9	910
MRE-2XCH TiMF-14T0.75	14×3×0.75	0.5	2.2	25.9	1010
MRE-2XCH TiMF-16T0.75	16×3×0.75	0.5	2.3	27.6	1140
MRE-2XCH TiMF-19T0.75	19×3×0.75	0.5	2.3	29.5	1300
MRE-2XCH TiMF-20T0.75	20×3×0.75	0.5	2.3	30.0	1350
MRE-2XCH TiMF-24T0.75	24×3×0.75	0.5	2.4	32.6	1590
MRE-2XCH TiMF-30T0.75	30×3×0.75	0.5	2.8	36.7	2030
MRE-2XCH TiMF-32T0.75	32×3×0.75	0.5	2.8	37.9	2150
MRE-2XCH TiMF-1T1.0	1×3×1.0	0.5	1.3	9.3	140



# IEC Standard Caledonian Offshore & Marine Cables

## MariSig Flame Retardant Instrumentation & Control Cables

[www.caledonian-cables.co.uk](http://www.caledonian-cables.co.uk)

Part No.	Construction No. of elements×No. of cores in element×Cross section(mm <sup>2</sup> )	Nominal Insulation Thickness mm	Nominal Sheath Thickness mm	Nominal Overall Diameter mm	Nominal Weight kg/km
MRE-2XCH TiMF-2T1.0	2×3×1.0	0.5	1.8	14.6	310
MRE-2XCH TiMF-3T1.0	3×3×1.0	0.5	1.8	15.4	370
MRE-2XCH TiMF-4T1.0	4×3×1.0	0.5	1.8	16.9	450
MRE-2XCH TiMF-5T1.0	5×3×1.0	0.5	1.8	18.5	530
MRE-2XCH TiMF-6T1.0	6×3×1.0	0.5	2.0	20.8	640
MRE-2XCH TiMF-7T1.0	7×3×1.0	0.5	2.0	20.8	680
MRE-2XCH TiMF-8T1.0	8×3×1.0	0.5	2.1	22.4	780
MRE-2XCH TiMF-10T1.0	10×3×1.0	0.5	2.2	25.2	960
MRE-2XCH TiMF-12T1.0	12×3×1.0	0.5	2.2	26.5	1080
MRE-2XCH TiMF-14T1.0	14×3×1.0	0.5	2.3	27.8	1220
MRE-2XCH TiMF-16T1.0	16×3×1.0	0.5	2.3	29.4	1360
MRE-2XCH TiMF-19T1.0	19×3×1.0	0.5	2.4	31.7	1580
MRE-2XCH TiMF-20T1.0	20×3×1.0	0.5	2.4	32.2	1640
MRE-2XCH TiMF-24T1.0	24×3×1.0	0.5	2.5	35.0	1930
MRE-2XCH TiMF-30T1.0	30×3×1.0	0.5	2.9	39.4	2470
MRE-2XCH TiMF-32T1.0	32×3×1.0	0.5	2.9	40.7	2620
MRE-2XCH TiMF-1T1.5	1×3×1.5	0.6	1.3	10.4	170
MRE-2XCH TiMF-2T1.5	2×3×1.5	0.6	1.8	16.5	380
MRE-2XCH TiMF-3T1.5	3×3×1.5	0.6	1.9	17.7	480
MRE-2XCH TiMF-4T1.5	4×3×1.5	0.6	1.9	19.2	570
MRE-2XCH TiMF-5T1.5	5×3×1.5	0.6	1.9	21.3	690
MRE-2XCH TiMF-6T1.5	6×3×1.5	0.6	2.1	24.0	840
MRE-2XCH TiMF-7T1.5	7×3×1.5	0.6	2.1	24.0	900
MRE-2XCH TiMF-8T1.5	8×3×1.5	0.6	2.2	25.8	1020
MRE-2XCH TiMF-10T1.5	10×3×1.5	0.6	2.3	29.1	1260
MRE-2XCH TiMF-12T1.5	12×3×1.5	0.6	2.4	30.9	1450
MRE-2XCH TiMF-14T1.5	14×3×1.5	0.6	2.4	32.2	1620
MRE-2XCH TiMF-16T1.5	16×3×1.5	0.6	2.5	34.3	1830
MRE-2XCH TiMF-19T1.5	19×3×1.5	0.6	2.8	37.5	2210
MRE-2XCH TiMF-20T1.5	20×3×1.5	0.6	2.8	38.1	2300
MRE-2XCH TiMF-24T1.5	24×3×1.5	0.6	3.0	41.6	2720
MRE-2XCH TiMF-30T1.5	30×3×1.5	0.6	3.1	45.9	3310
MRE-2XCH TiMF-32T1.5	32×3×1.5	0.6	3.2	47.7	3530



### ROI/ ROU (MRE-3GCH)

### 150/250V HEPR Insulated, LSOH (SHF1) Sheathed, Armoured Flame Retardant Instrumentation & Control Cables (Multipair)

#### Application

These armoured cables are used on board of ships in all locations for fixed installations where cable protection is required. These cables are flame retardant, low smoke & halogen free, suitable for installations on passenger ships, as on other commercial vessels.

#### Standards

- DIN 89159/98
- IEC 60092-360/375
- IEC 60332-1
- IEC 60332-3-22
- IEC 60754-1/2
- IEC 61034

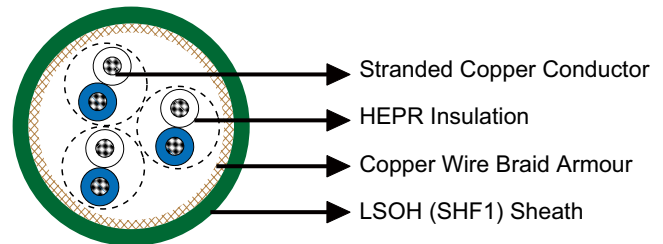

#### Construction

- Conductors: Stranded copper conductor.
- Insulation: HEPR.
- Cabling Element: Pair.
- Armour: Copper wire braid.
- Outer Sheath: LSOH (SHF1).

#### Core Identification

Pair: white/ blue with printed pair number and core number.

#### Mechanical and Thermal Properties

Bending Radius for Fixed Installations:  $6 \times OD$   
Temperature Range:  $-30^{\circ}\text{C} \sim +75^{\circ}\text{C}$



# IEC Standard Caledonian Offshore & Marine Cables

## MariSig Flame Retardant Instrumentation & Control Cables

[www.caledonian-cables.co.uk](http://www.caledonian-cables.co.uk)

### Dimensions and Weight

Part No.	Construction No. of elements×No. of cores in element×Cross section(mm <sup>2</sup> )	Nominal Insulation Thickness mm	Nominal Sheath Thickness mm	Nominal Overall Diameter mm	Nominal Weight kg/km
MRE-3GCH-1P0.75	1×2×0.75	0.5	1.2	8.5	90
MRE-3GCH-2P0.75	2×2×0.75*	0.5	1.3	9.5	130
MRE-3GCH-4P0.75	4×2×0.75	0.5	1.4	13.0	230
MRE-3GCH-7P0.75	7×2×0.75	0.5	1.8	15.5	340
MRE-3GCH-10P0.75	10×2×0.75	0.5	1.9	18.5	470
MRE-3GCH-14P0.75	14×2×0.75	0.5	2.0	21.0	610
MRE-3GCH-19P0.75	19×2×0.75	0.5	2.1	23.5	770
MRE-3GCH-24P0.75	24×2×0.75	0.5	2.2	26.5	950

\*: 2 pairs are assembled as a quad.





### BI/ BU (MRE-M2XH)

### 150/250V Mica Tape + XLPE Insulated, LSOH (SHF1) Sheathed Fire Resistant Instrumentation & Control Cables (Multicore)

#### Application

These cables are used on board of ships in all locations for fixed installations not subject to mechanical risk complying with IEC standards 60092-352 in safety circuit, where fire resistance is required. These cables are fire resistant, flame retardant, low smoke & halogen free, suitable for installations on passenger ships, as on other commercial vessels.

#### Standards

- IEC 60092-350/360/376
- IEC 60331-21
- IEC 60332-1
- IEC 60332-3-22
- IEC 60754-1/2
- IEC 61034

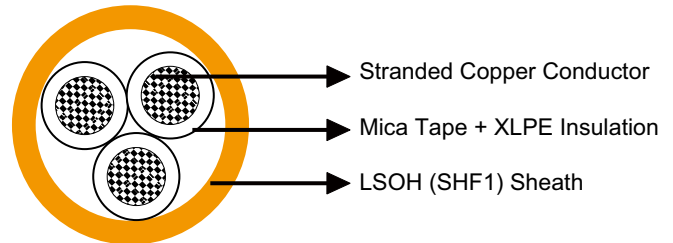

#### Construction

- Conductors: Class 2 stranded copper conductor.
- Insulation: Mica tape + XLPE.
- Outer Sheath: LSOH (SHF1). SHF2 can be offered upon request.

#### Core Identification

White with printed number.

#### Mechanical and Thermal Properties

Bending Radius for Fixed Installations:  $4 \times OD$   
Temperature Range:  $-30^{\circ}\text{C} \sim +80^{\circ}\text{C}$



### Dimensions and Weight

Part No.	Construction No. of cores×Cross section(mm <sup>2</sup> )	Nominal Insulation Thickness mm	Nominal Sheath Thickness mm	Nominal Overall Diameter mm	Nominal Weight kg/km
MRE-M2XH-2C0.75	2×0.75	0.5	1.1	6.3	63
MRE-M2XH-4C0.75	4×0.75	0.5	1.2	6.7	84







### BFOI (c)/BFOU (c) (MRE-M2X(St)CH)

### 150/250V Mica Tape + XLPE Insulated, LSOH (SHF1) Sheathed, Overall Screened & Armoured Fire Resistant Instrumentation & Control Cables (Multipair/Multitriple)

#### Application

These cables are used on board of ships in all locations for fixed installations complying with IEC standards 60092-352 in safety circuit, where fire resistance is required. These cables are fire resistant, flame retardant, low smoke & halogen free, suitable for installations on passenger ships, as on other commercial vessels.

#### Standards

- IEC 60092-350/360/376
- IEC 60331-21
- IEC 60332-1
- IEC 60332-3-22
- IEC 60754-1/2
- IEC 61034



#### Approvals:

BV Certification(33493/B0 BV)

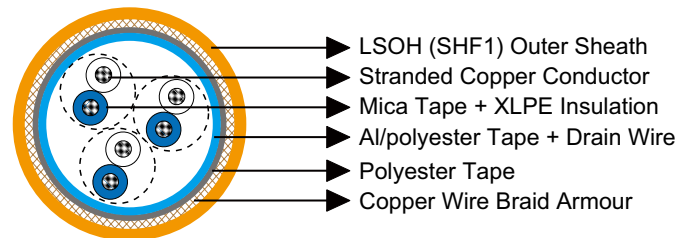

#### Construction

- Conductors: Class 2 stranded copper conductor.
- Insulation: Mica tape + XLPE insulation.
- Cabling Element: Pair/Triple.
- Overall Screen: Al/polyester tape.
- Drain Wire: Tinned copper wire.
- Inner Covering: Lapped polyester tape.





# IEC Standard Caledonian Offshore & Marine Cables

## MariSig Fire Resistant Instrumentation & Control Cables

www.caledonian-cables.co.uk

- Armour: Copper wire braid.
- Outer Sheath: LSOH (SHF1). SHF2 can be offered upon request.

### Core Identification

Pair: White/blue with printed pair number and core number.

Triple: White/blue/red with printed triple number.

### Mechanical and Thermal Properties

Bending Radius for Fixed Installations:  $6 \times OD$

Temperature Range:  $-30^{\circ}\text{C} \sim +80^{\circ}\text{C}$

### Dimensions and Weight

Part No.	Construction No. of elements×No. of cores in element×Cross section(mm <sup>2</sup> )	Nominal Insulation Thickness mm	Nominal Sheath Thickness mm	Nominal Overall Diameter mm	Nominal Weight kg/km
MRE-M2X(St)CH-1P0.75	1×2×0.75	0.5	1.1	9.3	120
MRE-M2X(St)CH-2P0.75	2×2×0.75*	0.5	1.1	10.5	160
MRE-M2X(St)CH-3P0.75	3×2×0.75	0.5	1.3	14.8	260
MRE-M2X(St)CH-4P0.75	4×2×0.75	0.5	1.3	15.6	300
MRE-M2X(St)CH-7P0.75	7×2×0.75	0.5	1.4	18.6	430
MRE-M2X(St)CH-8P0.75	8×2×0.75	0.5	1.5	19.9	480
MRE-M2X(St)CH-10P0.75	10×2×0.75	0.5	1.6	22.4	580
MRE-M2X(St)CH-12P0.75	12×2×0.75	0.5	1.6	23.2	640
MRE-M2X(St)CH-14P0.75	14×2×0.75	0.5	1.6	24.0	710
MRE-M2X(St)CH-16P0.75	16×2×0.75	0.5	1.7	25.9	800
MRE-M2X(St)CH-19P0.75	19×2×0.75	0.5	1.7	27.0	890
MRE-M2X(St)CH-24P0.75	24×2×0.75	0.5	1.9	30.8	1110
MRE-M2X(St)CH-30P0.75	30×2×0.75	0.5	2.0	34.4	1350
MRE-M2X(St)CH-32P0.75	32×2×0.75	0.5	2.0	34.9	1410
MRE-M2X(St)CH-37P0.75	37×2×0.75	0.5	2.1	37.3	1680
MRE-M2X(St)CH-1P1.0	1×2×1.0	0.5	1.1	9.7	130
MRE-M2X(St)CH-2P1.0	2×2×1.0*	0.5	1.1	10.9	170
MRE-M2X(St)CH-3P1.0	3×2×1.0	0.5	1.3	15.5	300
MRE-M2X(St)CH-4P1.0	4×2×1.0	0.5	1.3	16.4	340
MRE-M2X(St)CH-7P1.0	7×2×1.0	0.5	1.5	19.8	500

# IEC Standard Caledonian Offshore & Marine Cables

## MariSig Fire Resistant Instrumentation & Control Cables



[www.caledonian-cables.co.uk](http://www.caledonian-cables.co.uk)

Part No.	Construction No. of elements×No. of cores in element×Cross section(mm <sup>2</sup> )	Nominal Insulation Thickness mm	Nominal Sheath Thickness mm	Nominal Overall Diameter mm	Nominal Weight kg/km
MRE-M2X(St)CH-8P1.0	8×2×1.0	0.5	1.5	21.0	560
MRE-M2X(St)CH-10P1.0	10×2×1.0	0.5	1.6	23.6	660
MRE-M2X(St)CH-12P1.0	12×2×1.0	0.5	1.6	24.5	740
MRE-M2X(St)CH-14P1.0	14×2×1.0	0.5	1.7	25.6	830
MRE-M2X(St)CH-16P1.0	16×2×1.0	0.5	1.8	27.6	940
MRE-M2X(St)CH-19P1.0	19×2×1.0	0.5	1.8	28.8	1060
MRE-M2X(St)CH-24P1.0	24×2×1.0	0.5	1.9	32.6	1300
MRE-M2X(St)CH-30P1.0	30×2×1.0	0.5	2.1	37.1	1690
MRE-M2X(St)CH-32P1.0	32×2×1.0	0.5	2.1	37.7	1770
MRE-M2X(St)CH-37P1.0	37×2×1.0	0.5	2.2	39.7	1990
MRE-M2X(St)CH-1P1.5	1×2×1.5	0.6	1.1	10.5	150
MRE-M2X(St)CH-2P1.5	2×2×1.5*	0.6	1.2	12.1	220
MRE-M2X(St)CH-3P1.5	3×2×1.5	0.6	1.4	17.2	360
MRE-M2X(St)CH-4P1.5	4×2×1.5	0.6	1.4	18.2	420
MRE-M2X(St)CH-7P1.5	7×2×1.5	0.6	1.5	21.8	620
MRE-M2X(St)CH-8P1.5	8×2×1.5	0.6	1.6	23.4	700
MRE-M2X(St)CH-10P1.5	10×2×1.5	0.6	1.7	26.3	840
MRE-M2X(St)CH-12P1.5	12×2×1.5	0.6	1.7	27.3	940
MRE-M2X(St)CH-14P1.5	14×2×1.5	0.6	1.8	28.5	1060
MRE-M2X(St)CH-16P1.5	16×2×1.5	0.6	1.9	30.8	1200
MRE-M2X(St)CH-19P1.5	19×2×1.5	0.6	1.9	32.1	1350
MRE-M2X(St)CH-24P1.5	24×2×1.5	0.6	2.1	37.1	1780
MRE-M2X(St)CH-30P1.5	30×2×1.5	0.6	2.3	41.6	2180
MRE-M2X(St)CH-32P1.5	32×2×1.5	0.6	2.3	42.3	2280
MRE-M2X(St)CH-37P1.5	37×2×1.5	0.6	2.4	44.5	2570
MRE-M2X(St)CH-1T0.75	1×3×0.75	0.5	1.1	9.7	130
MRE-M2X(St)CH-2T0.75	2×3×0.75	0.5	1.3	15.0	270
MRE-M2X(St)CH-3T0.75	3×3×0.75	0.5	1.3	15.8	320
MRE-M2X(St)CH-4T0.75	4×3×0.75	0.5	1.4	17.4	390
MRE-M2X(St)CH-7T0.75	7×3×0.75	0.5	1.5	21.5	590
MRE-M2X(St)CH-8T0.75	8×3×0.75	0.5	1.6	23.1	660
MRE-M2X(St)CH-10T0.75	10×3×0.75	0.5	1.7	26.1	790
MRE-M2X(St)CH-12T0.75	12×3×0.75	0.5	1.8	27.7	900
MRE-M2X(St)CH-14T0.75	14×3×0.75	0.5	1.8	28.8	1000
MRE-M2X(St)CH-16T0.75	16×3×0.75	0.5	1.9	30.7	1130
MRE-M2X(St)CH-19T0.75	19×3×0.75	0.5	2.0	33.1	1300





# IEC Standard Caledonian Offshore & Marine Cables

## MariSig Fire Resistant Instrumentation & Control Cables

www.caledonian-cables.co.uk

Part No.	Construction No. of elements×No. of cores in element×Cross section(mm <sup>2</sup> )	Nominal Insulation Thickness mm	Nominal Sheath Thickness mm	Nominal Overall Diameter mm	Nominal Weight kg/km
MRE-M2X(St)CH-24T0.75	24×3×0.75	0.5	2.1	37.1	1680
MRE-M2X(St)CH-30T0.75	30×3×0.75	0.5	2.3	41.1	2040
MRE-M2X(St)CH-32T0.75	32×3×0.75	0.5	2.3	42.5	2150
MRE-M2X(St)CH-37T0.75	37×3×0.75	0.5	2.4	44.7	2420
MRE-M2X(St)CH-1T1.0	1×3×1.0	0.5	1.1	10.2	150
MRE-M2X(St)CH-2T1.0	2×3×1.0	0.5	1.3	15.9	310
MRE-M2X(St)CH-3T1.0	3×3×1.0	0.5	1.4	17.0	380
MRE-M2X(St)CH-4T1.0	4×3×1.0	0.5	1.4	18.5	450
MRE-M2X(St)CH-7T1.0	7×3×1.0	0.5	1.6	23.1	690
MRE-M2X(St)CH-8T1.0	8×3×1.0	0.5	1.6	24.6	770
MRE-M2X(St)CH-10T1.0	10×3×1.0	0.5	1.8	28.0	930
MRE-M2X(St)CH-12T1.0	12×3×1.0	0.5	1.8	29.5	1050
MRE-M2X(St)CH-14T1.0	14×3×1.0	0.5	1.9	30.9	1190
MRE-M2X(St)CH-16T1.0	16×3×1.0	0.5	1.9	32.7	1320
MRE-M2X(St)CH-19T1.0	19×3×1.0	0.5	2.0	35.4	1530
MRE-M2X(St)CH-24T1.0	24×3×1.0	0.5	2.2	39.9	1990
MRE-M2X(St)CH-30T1.0	30×3×1.0	0.5	2.4	44.2	2420
MRE-M2X(St)CH-32T1.0	32×3×1.0	0.5	2.4	45.7	2560
MRE-M2X(St)CH-37T1.0	37×3×1.0	0.5	2.5	48.0	2870
MRE-M2X(St)CH-1T1.5	1×3×1.5	0.6	1.1	11.0	180
MRE-M2X(St)CH-2T1.5	2×3×1.5	0.6	1.4	17.5	370
MRE-M2X(St)CH-3T1.5	3×3×1.5	0.6	1.4	18.5	450
MRE-M2X(St)CH-4T1.5	4×3×1.5	0.6	1.5	20.4	560
MRE-M2X(St)CH-7T1.5	7×3×1.5	0.6	1.7	25.5	870
MRE-M2X(St)CH-8T1.5	8×3×1.5	0.6	1.7	27.2	970
MRE-M2X(St)CH-10T1.5	10×3×1.5	0.6	1.9	31.0	1170
MRE-M2X(St)CH-12T1.5	12×3×1.5	0.6	1.9	32.7	1340
MRE-M2X(St)CH-14T1.5	14×3×1.5	0.6	2.0	34.3	1510
MRE-M2X(St)CH-16T1.5	16×3×1.5	0.6	2.1	37.0	1800
MRE-M2X(St)CH-19T1.5	19×3×1.5	0.6	2.2	39.9	2080
MRE-M2X(St)CH-24T1.5	24×3×1.5	0.6	2.4	44.4	2560
MRE-M2X(St)CH-30T1.5	30×3×1.5	0.6	2.6	49.2	3110
MRE-M2X(St)CH-32T1.5	32×3×1.5	0.6	2.6	50.9	3300
MRE-M2X(St)CH-37T1.5	37×3×1.5	0.6	2.7	53.4	3710

\*: 2 pairs are assembled as a quad.



### BI (c)/ BU(c) (MRE-M2X(St)H)

### 150/250V Mica Tape + XLPE Insulated, LSOH (SHF1) Sheathed, Overall Screened Fire Resistant Instrumentation & Control Cables (Multipair/Multitriples)

#### Application

These cables are used on board of ships in all locations for fixed installations not subject to mechanical risk complying with IEC standards 60092-352 in safety circuit, where fire resistance is required. These cables are fire resistant, flame retardant, low smoke & halogen free, suitable for installations on passenger ships, as on other commercial vessels.

#### Standards

- IEC 60092-350/360/376
- IEC 60331-21
- IEC 60332-1
- IEC 60332-3-22
- IEC 60754-1/2
- IEC 61034

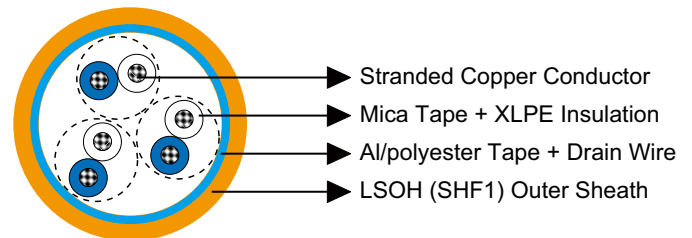

#### Construction

- Conductors: Class 2 stranded copper conductor.
- Insulation: Mica tape + XLPE.
- Cabling Element: Pair/Triples.
- Overall Screen: Al/polyester tape.
- Drain Wire: Tinned copper wire.
- Outer Sheath: LSOH (SHF1). SHF2 can be offered upon request.

#### Core Identification

Pair: White/blue with printed pair number and core number.

Triple: White/blue/red with printed triple number.



### Mechanical and Thermal Properties

Bending Radius for Fixed Installations:  $6 \times OD$  ( $OD > 25\text{mm}$ );  $4 \times OD$  ( $OD \leq 25\text{mm}$ )

Temperature Range:  $-30^{\circ}\text{C} \sim +80^{\circ}\text{C}$

### Dimensions and Weight

Part No.	Construction No. of elements $\times$ No. of cores in element $\times$ Cross section ( $\text{mm}^2$ )	Nominal Insulation Thickness mm	Nominal Sheath Thickness mm	Nominal Overall Diameter mm	Nominal Weight kg/km
MRE-M2X(St)H-1P0.75	1 $\times$ 2 $\times$ 0.75	0.5	1.0	8.1	70
MRE-M2X(St)H-2P0.75	2 $\times$ 2 $\times$ 0.75*	0.5	1.1	9.5	110
MRE-M2X(St)H-3P0.75	3 $\times$ 2 $\times$ 0.75	0.5	1.2	13.3	170
MRE-M2X(St)H-4P0.75	4 $\times$ 2 $\times$ 0.75	0.5	1.3	14.3	210
MRE-M2X(St)H-7P0.75	7 $\times$ 2 $\times$ 0.75	0.5	1.4	17.3	320
MRE-M2X(St)H-8P0.75	8 $\times$ 2 $\times$ 0.75	0.5	1.4	18.4	360
MRE-M2X(St)H-10P0.75	10 $\times$ 2 $\times$ 0.75	0.5	1.5	20.9	430
MRE-M2X(St)H-12P0.75	12 $\times$ 2 $\times$ 0.75	0.5	1.5	21.7	490
MRE-M2X(St)H-14P0.75	14 $\times$ 2 $\times$ 0.75	0.5	1.6	22.7	560
MRE-M2X(St)H-16P0.75	16 $\times$ 2 $\times$ 0.75	0.5	1.6	24.4	630
MRE-M2X(St)H-19P0.75	19 $\times$ 2 $\times$ 0.75	0.5	1.7	25.7	730
MRE-M2X(St)H-24P0.75	24 $\times$ 2 $\times$ 0.75	0.5	1.8	29.3	910
MRE-M2X(St)H-30P0.75	30 $\times$ 2 $\times$ 0.75	0.5	2.0	33.1	1140
MRE-M2X(St)H-32P0.75	32 $\times$ 2 $\times$ 0.75	0.5	2.0	33.6	1190
MRE-M2X(St)H-37P0.75	37 $\times$ 2 $\times$ 0.75	0.5	2.0	35.3	1340
MRE-M2X(St)H-1P1.0	1 $\times$ 2 $\times$ 1.0	0.5	1.1	8.7	90
MRE-M2X(St)H-2P1.0	2 $\times$ 2 $\times$ 1.0*	0.5	1.1	9.9	130
MRE-M2X(St)H-3P1.0	3 $\times$ 2 $\times$ 1.0	0.5	1.3	14.2	200
MRE-M2X(St)H-4P1.0	4 $\times$ 2 $\times$ 1.0	0.5	1.3	15.1	240
MRE-M2X(St)H-7P1.0	7 $\times$ 2 $\times$ 1.0	0.5	1.4	18.3	370
MRE-M2X(St)H-8P1.0	8 $\times$ 2 $\times$ 1.0	0.5	1.5	19.7	430
MRE-M2X(St)H-10P1.0	10 $\times$ 2 $\times$ 1.0	0.5	1.6	22.3	520
MRE-M2X(St)H-12P1.0	12 $\times$ 2 $\times$ 1.0	0.5	1.6	23.2	590
MRE-M2X(St)H-14P1.0	14 $\times$ 2 $\times$ 1.0	0.5	1.6	24.1	660
MRE-M2X(St)H-16P1.0	16 $\times$ 2 $\times$ 1.0	0.5	1.7	26.1	760
MRE-M2X(St)H-19P1.0	19 $\times$ 2 $\times$ 1.0	0.5	1.7	27.3	860
MRE-M2X(St)H-24P1.0	24 $\times$ 2 $\times$ 1.0	0.5	1.9	31.3	1100
MRE-M2X(St)H-30P1.0	30 $\times$ 2 $\times$ 1.0	0.5	2.0	35.1	1350

# IEC Standard Caledonian Offshore & Marine Cables

## MariSig Fire Resistant Instrumentation & Control Cables



[www.caledonian-cables.co.uk](http://www.caledonian-cables.co.uk)

Part No.	Construction No. of elements×No. of cores in element×Cross section(mm <sup>2</sup> )	Nominal Insulation Thickness mm	Nominal Sheath Thickness mm	Nominal Overall Diameter mm	Nominal Weight kg/km
MRE-M2X(St)H-32P1.0	32×2×1.0	0.5	2.1	35.9	1440
MRE-M2X(St)H-37P1.0	37×2×1.0	0.5	2.1	37.7	1620
MRE-M2X(St)H-1P1.5	1×2×1.5	0.6	1.1	9.5	100
MRE-M2X(St)H-2P1.5	2×2×1.5*	0.6	1.1	10.9	160
MRE-M2X(St)H-3P1.5	3×2×1.5	0.6	1.3	15.7	250
MRE-M2X(St)H-4P1.5	4×2×1.5	0.6	1.4	16.9	310
MRE-M2X(St)H-7P1.5	7×2×1.5	0.6	1.5	20.5	490
MRE-M2X(St)H-8P1.5	8×2×1.5	0.6	1.5	21.9	550
MRE-M2X(St)H-10P1.5	10×2×1.5	0.6	1.7	25.0	670
MRE-M2X(St)H-12P1.5	12×2×1.5	0.6	1.7	26.0	770
MRE-M2X(St)H-14P1.5	14×2×1.5	0.6	1.7	27.0	870
MRE-M2X(St)H-16P1.5	16×2×1.5	0.6	1.8	29.3	990
MRE-M2X(St)H-19P1.5	19×2×1.5	0.6	1.9	30.8	1150
MRE-M2X(St)H-24P1.5	24×2×1.5	0.6	2.0	35.1	1440
MRE-M2X(St)H-30P1.5	30×2×1.5	0.6	2.2	39.6	1790
MRE-M2X(St)H-32P1.5	32×2×1.5	0.6	2.2	40.3	1890
MRE-M2X(St)H-37P1.5	37×2×1.5	0.6	2.3	42.5	2160
MRE-M2X(St)H-1T0.75	1×3×0.75	0.5	1.1	8.7	90
MRE-M2X(St)H-2T0.75	2×3×0.75	0.5	1.2	13.5	180
MRE-M2X(St)H-3T0.75	3×3×0.75	0.5	1.3	14.5	230
MRE-M2X(St)H-4T0.75	4×3×0.75	0.5	1.3	15.9	280
MRE-M2X(St)H-7T0.75	7×3×0.75	0.5	1.5	20.2	460
MRE-M2X(St)H-8T0.75	8×3×0.75	0.5	1.5	21.6	510
MRE-M2X(St)H-10T0.75	10×3×0.75	0.5	1.6	24.6	620
MRE-M2X(St)H-12T0.75	12×3×0.75	0.5	1.7	26.2	720
MRE-M2X(St)H-14T0.75	14×3×0.75	0.5	1.7	27.3	810
MRE-M2X(St)H-16T0.75	16×3×0.75	0.5	1.8	29.2	920
MRE-M2X(St)H-19T0.75	19×3×0.75	0.5	1.9	31.6	1080
MRE-M2X(St)H-24T0.75	24×3×0.75	0.5	2.0	35.1	1340
MRE-M2X(St)H-30T0.75	30×3×0.75	0.5	2.2	39.1	1660
MRE-M2X(St)H-32T0.75	32×3×0.75	0.5	2.2	40.5	1760
MRE-M2X(St)H-37T0.75	37×3×0.75	0.5	2.3	42.7	2000
MRE-M2X(St)H-1T1.0	1×3×1.0	0.5	1.1	9.2	110
MRE-M2X(St)H-2T1.0	2×3×1.0	0.5	1.3	14.6	210
MRE-M2X(St)H-3T1.0	3×3×1.0	0.5	1.3	15.5	270
MRE-M2X(St)H-4T1.0	4×3×1.0	0.5	1.4	17.2	340





# IEC Standard Caledonian Offshore & Marine Cables

## MariSig Fire Resistant Instrumentation & Control Cables

www.caledonian-cables.co.uk

Part No.	Construction No. of elements×No. of cores in element×Cross section(mm <sup>2</sup> )	Nominal Insulation Thickness mm	Nominal Sheath Thickness mm	Nominal Overall Diameter mm	Nominal Weight kg/km
MRE-M2X(St)H-7T1.0	7×3×1.0	0.5	1.5	21.6	540
MRE-M2X(St)H-8T1.0	8×3×1.0	0.5	1.6	23.3	620
MRE-M2X(St)H-10T1.0	10×3×1.0	0.5	1.7	26.5	740
MRE-M2X(St)H-12T1.0	12×3×1.0	0.5	1.8	28.2	870
MRE-M2X(St)H-14T1.0	14×3×1.0	0.5	1.8	29.4	980
MRE-M2X(St)H-16T1.0	16×3×1.0	0.5	1.9	31.4	1110
MRE-M2X(St)H-19T1.0	19×3×1.0	0.5	2.0	34.1	1310
MRE-M2X(St)H-24T1.0	24×3×1.0	0.5	2.1	37.9	1620
MRE-M2X(St)H-30T1.0	30×3×1.0	0.5	2.3	42.2	2010
MRE-M2X(St)H-32T1.0	32×3×1.0	0.5	2.4	43.9	2150
MRE-M2X(St)H-37T1.0	37×3×1.0	0.5	2.4	46.0	2430
MRE-M2X(St)H-1T1.5	1×3×1.5	0.6	1.1	10.0	130
MRE-M2X(St)H-2T1.5	2×3×1.5	0.6	1.3	16.0	260
MRE-M2X(St)H-3T1.5	3×3×1.5	0.6	1.4	17.2	340
MRE-M2X(St)H-4T1.5	4×3×1.5	0.6	1.4	18.9	430
MRE-M2X(St)H-7T1.5	7×3×1.5	0.6	1.6	24.0	700
MRE-M2X(St)H-8T1.5	8×3×1.5	0.6	1.7	25.9	800
MRE-M2X(St)H-10T1.5	10×3×1.5	0.6	1.8	29.5	970
MRE-M2X(St)H-12T1.5	12×3×1.5	0.6	1.9	31.4	1130
MRE-M2X(St)H-14T1.5	14×3×1.5	0.6	2.0	33.0	1300
MRE-M2X(St)H-16T1.5	16×3×1.5	0.6	2.0	35.0	1460
MRE-M2X(St)H-19T1.5	19×3×1.5	0.6	2.1	37.9	1710
MRE-M2X(St)H-24T1.5	24×3×1.5	0.6	2.3	42.4	2140
MRE-M2X(St)H-30T1.5	30×3×1.5	0.6	2.5	47.2	2660
MRE-M2X(St)H-32T1.5	32×3×1.5	0.6	2.5	48.9	2820
MRE-M2X(St)H-37T1.5	37×3×1.5	0.6	2.6	51.4	3210

\*: 2 pairs are assembled as a quad.





### BI (i)/ BU(i) (MRE-M2XH PiMF/TiMF)

150/250V Mica Tape + XLPE Insulated, LSOH (SHF1) Sheathed,

Individual Screened Fire Resistant Instrumentation & Control

Cables (Multipair/Multitriples)

### Application

These cables are used on board of ships in all locations for fixed installations not subject to mechanical risk complying with IEC standards 60092-352 in safety circuit, where fire resistance is required. These cables are fire resistant, flame retardant, low smoke & halogen free, suitable for installations on passenger ships, as on other commercial vessels.

### Standards

- IEC 60092-350/360/376
- IEC 60331-21
- IEC 60332-1
- IEC 60332-3-22
- IEC 60754-1/2
- IEC 61034

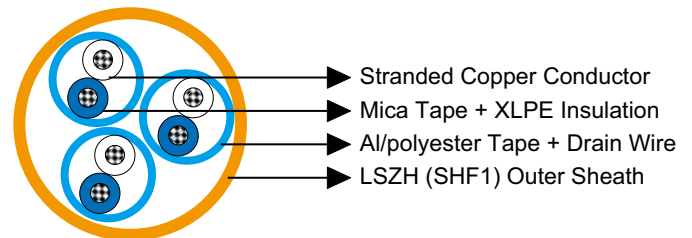

### Construction

- Conductors: Class 2 stranded copper conductor.
- Insulation: Mica tape + XLPE.
- Cabling Element: Pair/Triple.
- Individual Screen: Al/polyester tape.
- Drain Wire: Tinned copper wire.
- Outer Sheath: LSOH (SHF1). SHF2 can be offered upon request.

### Core Identification

Pair: White/blue with printed pair number and core number.

Triple: White/blue/red with printed triple number.



### Mechanical and Thermal Properties

Bending Radius for Fixed Installations:  $6 \times OD$  ( $OD > 25\text{mm}$ );  $4 \times OD$  ( $OD \leq 25\text{mm}$ )

Temperature Range:  $-30^{\circ}\text{C} \sim +80^{\circ}\text{C}$

### Dimensions and Weight

Part No.	Construction No. of elements $\times$ No. of cores in element $\times$ Cross section ( $\text{mm}^2$ )	Nominal Insulation Thickness mm	Nominal Sheath Thickness mm	Nominal Overall Diameter mm	Nominal Weight kg/km
MRE-M2XH PiMF-1P0.75	1 $\times$ 2 $\times$ 0.75	0.5	1.0	7.9	80
MRE-M2XH PiMF-2P0.75	2 $\times$ 2 $\times$ 0.75	0.5	1.2	12.4	170
MRE-M2XH PiMF-3P0.75	3 $\times$ 2 $\times$ 0.75	0.5	1.2	13.2	210
MRE-M2XH PiMF-4P0.75	4 $\times$ 2 $\times$ 0.75	0.5	1.3	14.3	260
MRE-M2XH PiMF-5P0.75	5 $\times$ 2 $\times$ 0.75	0.5	1.3	16.0	320
MRE-M2XH PiMF-6P0.75	6 $\times$ 2 $\times$ 0.75	0.5	1.4	17.4	380
MRE-M2XH PiMF-7P0.75	7 $\times$ 2 $\times$ 0.75	0.5	1.4	17.4	410
MRE-M2XH PiMF-8P0.75	8 $\times$ 2 $\times$ 0.75	0.5	1.4	18.5	460
MRE-M2XH PiMF-10P0.75	10 $\times$ 2 $\times$ 0.75	0.5	1.5	21.0	570
MRE-M2XH PiMF-12P0.75	12 $\times$ 2 $\times$ 0.75	0.5	1.5	21.8	650
MRE-M2XH PiMF-14P0.75	14 $\times$ 2 $\times$ 0.75	0.5	1.6	22.9	740
MRE-M2XH PiMF-16P0.75	16 $\times$ 2 $\times$ 0.75	0.5	1.6	24.6	840
MRE-M2XH PiMF-19P0.75	19 $\times$ 2 $\times$ 0.75	0.5	1.7	26.5	980
MRE-M2XH PiMF-20P0.75	20 $\times$ 2 $\times$ 0.75	0.5	1.7	26.5	1010
MRE-M2XH PiMF-24P0.75	24 $\times$ 2 $\times$ 0.75	0.5	1.9	30.6	1260
MRE-M2XH PiMF-30P0.75	30 $\times$ 2 $\times$ 0.75	0.5	2.0	33.4	1530
MRE-M2XH PiMF-37P0.75	37 $\times$ 2 $\times$ 0.75	0.5	2.1	35.9	1830
MRE-M2XH PiMF-1P1.0	1 $\times$ 2 $\times$ 1.0	0.5	1.0	8.3	90
MRE-M2XH PiMF-2P1.0	2 $\times$ 2 $\times$ 1.0	0.5	1.2	13.1	200
MRE-M2XH PiMF-3P1.0	3 $\times$ 2 $\times$ 1.0	0.5	1.3	14.2	250
MRE-M2XH PiMF-4P1.0	4 $\times$ 2 $\times$ 1.0	0.5	1.3	15.1	310
MRE-M2XH PiMF-5P1.0	5 $\times$ 2 $\times$ 1.0	0.5	1.4	17.1	380
MRE-M2XH PiMF-6P1.0	6 $\times$ 2 $\times$ 1.0	0.5	1.4	18.4	440
MRE-M2XH PiMF-7P1.0	7 $\times$ 2 $\times$ 1.0	0.5	1.4	18.4	480
MRE-M2XH PiMF-8P1.0	8 $\times$ 2 $\times$ 1.0	0.5	1.5	19.8	550
MRE-M2XH PiMF-10P1.0	10 $\times$ 2 $\times$ 1.0	0.5	1.6	22.4	690
MRE-M2XH PiMF-12P1.0	12 $\times$ 2 $\times$ 1.0	0.5	1.6	23.3	780
MRE-M2XH PiMF-14P1.0	14 $\times$ 2 $\times$ 1.0	0.5	1.6	24.2	880
MRE-M2XH PiMF-16P1.0	16 $\times$ 2 $\times$ 1.0	0.5	1.7	26.3	1020
MRE-M2XH PiMF-19P1.0	19 $\times$ 2 $\times$ 1.0	0.5	1.8	28.3	1190



Part No.	Construction No. of elements×No. of cores in element×Cross section(mm <sup>2</sup> )	Nominal Insulation Thickness mm	Nominal Sheath Thickness mm	Nominal Overall Diameter mm	Nominal Weight kg/km
MRE-M2XH PiMF-20P1.0	20×2×1.0	0.5	1.8	28.3	1230
MRE-M2XH PiMF-24P1.0	24×2×1.0	0.5	1.9	32.5	1510
MRE-M2XH PiMF-30P1.0	30×2×1.0	0.5	2.0	35.4	1840
MRE-M2XH PiMF-37P1.0	37×2×1.0	0.5	2.1	38.1	2210
MRE-M2XH TiMF-1T0.75	1×3×0.75	0.5	1.0	8.3	100
MRE-M2XH TiMF-2T0.75	2×3×0.75	0.5	1.2	13.5	210
MRE-M2XH TiMF-3T0.75	3×3×0.75	0.5	1.3	14.5	270
MRE-M2XH TiMF-4T0.75	4×3×0.75	0.5	1.3	16.0	330
MRE-M2XH TiMF-5T0.75	5×3×0.75	0.5	1.4	17.9	410
MRE-M2XH TiMF-6T0.75	6×3×0.75	0.5	1.5	20.3	500
MRE-M2XH TiMF-7T0.75	7×3×0.75	0.5	1.5	20.3	540
MRE-M2XH TiMF-8T0.75	8×3×0.75	0.5	1.5	21.8	620
MRE-M2XH TiMF-10T0.75	10×3×0.75	0.5	1.7	25.0	780
MRE-M2XH TiMF-12T0.75	12×3×0.75	0.5	1.7	26.4	900
MRE-M2XH TiMF-14T0.75	14×3×0.75	0.5	1.8	27.7	1020
MRE-M2XH TiMF-16T0.75	16×3×0.75	0.5	1.8	29.5	1160
MRE-M2XH TiMF-19T0.75	19×3×0.75	0.5	1.9	32.0	1360
MRE-M2XH TiMF-20T0.75	20×3×0.75	0.5	1.9	32.5	1420
MRE-M2XH TiMF-24T0.75	24×3×0.75	0.5	2.1	35.7	1700
MRE-M2XH TiMF-30T0.75	30×3×0.75	0.5	2.2	39.6	2100
MRE-M2XH TiMF-32T0.75	32×3×0.75	0.5	2.3	41.2	2250
MRE-M2XH TiMF-1T1.0	1×3×1.0	0.5	1.1	8.9	120
MRE-M2XH TiMF-2T1.0	2×3×1.0	0.5	1.3	14.4	250
MRE-M2XH TiMF-3T1.0	3×3×1.0	0.5	1.3	15.4	310
MRE-M2XH TiMF-4T1.0	4×3×1.0	0.5	1.4	17.1	400
MRE-M2XH TiMF-5T1.0	5×3×1.0	0.5	1.4	18.9	480
MRE-M2XH TiMF-6T1.0	6×3×1.0	0.5	1.5	21.5	590
MRE-M2XH TiMF-7T1.0	7×3×1.0	0.5	1.5	21.5	640
MRE-M2XH TiMF-8T1.0	8×3×1.0	0.5	1.6	23.3	740
MRE-M2XH TiMF-10T1.0	10×3×1.0	0.5	1.7	26.5	930
MRE-M2XH TiMF-12T1.0	12×3×1.0	0.5	1.8	28.2	1090
MRE-M2XH TiMF-14T1.0	14×3×1.0	0.5	1.8	29.4	1220
MRE-M2XH TiMF-16T1.0	16×3×1.0	0.5	1.9	31.5	1400
MRE-M2XH TiMF-19T1.0	19×3×1.0	0.5	2.0	34.1	1640
MRE-M2XH TiMF-20T1.0	20×3×1.0	0.5	2.0	34.7	1710
MRE-M2XH TiMF-24T1.0	24×3×1.0	0.5	2.1	37.9	2040
MRE-M2XH TiMF-30T1.0	30×3×1.0	0.5	2.3	42.3	2540
MRE-M2XH TiMF-32T1.0	32×3×1.0	0.5	2.4	44.0	2720



### BFOI/ BFOU (MRE-M2XCH)

150/250V Mica Tape + XLPE Insulated, LSOH (SHF1) Sheathed,

Armoured Fire Resistant Instrumentation & Control Cables

(Multipair/Multitriples)

### Application

These cables are used on board of ships in all locations for fixed installations complying with IEC standards 60092-352 in safety circuit, where fire resistance is required. These cables are fire resistant, flame retardant, low smoke & halogen free, suitable for installations on passenger ships, as on other commercial vessels.

### Standards

- IEC 60092-350/360/376
- IEC 60331-21
- IEC 60332-1
- IEC 60332-3-22
- IEC 60754-1/2
- IEC 61034

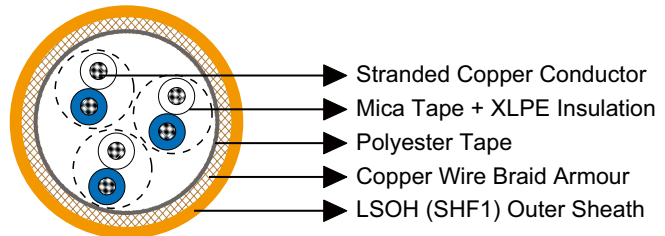

### Construction

- Conductors: Class 2 stranded copper conductor.
- Insulation: Mica tape + XLPE.
- Cabling Element: Pair/Triple.
- Inner Covering: Lapped polyester tape.
- Armour: Copper wire braid.
- Outer Sheath: LSOH (SHF1). SHF2 can be offered upon request.

### Core Identification

Pair: White/blue with printed pair number and core number.

Triple: White/blue/red with printed triple number.



### Mechanical and Thermal Properties

Bending Radius for Fixed Installations:  $6 \times OD$   
 Temperature Range:  $-30^{\circ}\text{C} \sim +80^{\circ}\text{C}$

### Dimensions and Weight

Part No.	Construction No. of elements $\times$ No. of cores in element $\times$ Cross section ( $\text{mm}^2$ )	Nominal Insulation Thickness mm	Nominal Sheath Thickness mm	Nominal Overall Diameter mm	Nominal Weight kg/km
MRE-M2XCH-1P0.75	1 $\times$ 2 $\times$ 0.75	0.5	1.3	9.1	120
MRE-M2XCH-2P0.75	2 $\times$ 2 $\times$ 0.75	0.5	1.3	10.2	150
MRE-M2XCH-3P0.75	3 $\times$ 2 $\times$ 0.75	0.5	1.8	14.6	280
MRE-M2XCH-4P0.75	4 $\times$ 2 $\times$ 0.75	0.5	1.8	15.4	320
MRE-M2XCH-5P0.75	5 $\times$ 2 $\times$ 0.75	0.5	1.9	17.2	390
MRE-M2XCH-6P0.75	6 $\times$ 2 $\times$ 0.75	0.5	1.9	18.3	440
MRE-M2XCH-7P0.75	7 $\times$ 2 $\times$ 0.75	0.5	1.9	18.3	460
MRE-M2XCH-8P0.75	8 $\times$ 2 $\times$ 0.75	0.5	2.0	19.6	520
MRE-M2XCH-10P0.75	10 $\times$ 2 $\times$ 0.75	0.5	2.0	21.7	620
MRE-M2XCH-12P0.75	12 $\times$ 2 $\times$ 0.75	0.5	2.1	22.8	700
MRE-M2XCH-14P0.75	14 $\times$ 2 $\times$ 0.75	0.5	2.1	23.6	770
MRE-M2XCH-16P0.75	16 $\times$ 2 $\times$ 0.75	0.5	2.2	25.4	870
MRE-M2XCH-19P0.75	19 $\times$ 2 $\times$ 0.75	0.5	2.2	27.0	990
MRE-M2XCH-20P0.75	20 $\times$ 2 $\times$ 0.75	0.5	2.2	27.0	1010
MRE-M2XCH-24P0.75	24 $\times$ 2 $\times$ 0.75	0.5	2.4	30.9	1240
MRE-M2XCH-30P0.75	30 $\times$ 2 $\times$ 0.75	0.5	2.5	33.5	1480
MRE-M2XCH-37P0.75	37 $\times$ 2 $\times$ 0.75	0.5	2.6	35.9	1730
MRE-M2XCH-1P1.0	1 $\times$ 2 $\times$ 1.0	0.5	1.3	9.5	130
MRE-M2XCH-2P1.0	2 $\times$ 2 $\times$ 1.0	0.5	1.3	10.7	170
MRE-M2XCH-3P1.0	3 $\times$ 2 $\times$ 1.0	0.5	1.8	15.3	320
MRE-M2XCH-4P1.0	4 $\times$ 2 $\times$ 1.0	0.5	1.8	16.2	360
MRE-M2XCH-5P1.0	5 $\times$ 2 $\times$ 1.0	0.5	1.9	18.1	440
MRE-M2XCH-6P1.0	6 $\times$ 2 $\times$ 1.0	0.5	2.0	19.5	510
MRE-M2XCH-7P1.0	7 $\times$ 2 $\times$ 1.0	0.5	2.0	19.5	530
MRE-M2XCH-8P1.0	8 $\times$ 2 $\times$ 1.0	0.5	2.0	20.7	590
MRE-M2XCH-10P1.0	10 $\times$ 2 $\times$ 1.0	0.5	2.1	23.2	730
MRE-M2XCH-12P1.0	12 $\times$ 2 $\times$ 1.0	0.5	2.1	24.1	810
MRE-M2XCH-14P1.0	14 $\times$ 2 $\times$ 1.0	0.5	2.2	25.1	900
MRE-M2XCH-16P1.0	16 $\times$ 2 $\times$ 1.0	0.5	2.2	26.9	1010
MRE-M2XCH-19P1.0	19 $\times$ 2 $\times$ 1.0	0.5	2.3	28.8	1160



# IEC Standard Caledonian Offshore & Marine Cables

## MariSig Fire Resistant Instrumentation & Control Cables

[www.caledonian-cables.co.uk](http://www.caledonian-cables.co.uk)

Part No.	Construction No. of elements×No. of cores in element×Cross section(mm <sup>2</sup> )	Nominal Insulation Thickness mm	Nominal Sheath Thickness mm	Nominal Overall Diameter mm	Nominal Weight kg/km
MRE-M2XCH-20P1.0	20×2×1.0	0.5	2.3	28.8	1190
MRE-M2XCH-24P1.0	24×2×1.0	0.5	2.5	33.0	1460
MRE-M2XCH-30P1.0	30×2×1.0	0.5	2.6	35.8	1740
MRE-M2XCH-37P1.0	37×2×1.0	0.5	2.9	38.8	2140
MRE-M2XCH-1P1.5	1×2×1.5	0.6	1.3	10.5	160
MRE-M2XCH-2P1.5	2×2×1.5	0.6	1.4	12.1	220
MRE-M2XCH-3P1.5	3×2×1.5	0.6	1.9	17.4	400
MRE-M2XCH-4P1.5	4×2×1.5	0.6	1.9	18.4	470
MRE-M2XCH-5P1.5	5×2×1.5	0.6	2.0	20.6	570
MRE-M2XCH-6P1.5	6×2×1.5	0.6	2.1	22.2	660
MRE-M2XCH-7P1.5	7×2×1.5	0.6	2.1	22.2	700
MRE-M2XCH-8P1.5	8×2×1.5	0.6	2.1	23.6	780
MRE-M2XCH-10P1.5	10×2×1.5	0.6	2.2	26.5	950
MRE-M2XCH-12P1.5	12×2×1.5	0.6	2.3	27.7	1070
MRE-M2XCH-14P1.5	14×2×1.5	0.6	2.3	28.7	1180
MRE-M2XCH-16P1.5	16×2×1.5	0.6	2.4	31.0	1350
MRE-M2XCH-19P1.5	19×2×1.5	0.6	2.5	33.2	1560
MRE-M2XCH-20P1.5	20×2×1.5	0.6	2.5	33.2	1590
MRE-M2XCH-24P1.5	24×2×1.5	0.6	2.9	38.5	2060
MRE-M2XCH-30P1.5	30×2×1.5	0.6	3.0	41.8	2450
MRE-M2XCH-37P1.5	37×2×1.5	0.6	3.1	44.7	2880
MRE-M2XCH-1T0.75	1×3×0.75	0.5	1.3	9.5	130
MRE-M2XCH-2T0.75	2×3×0.75	0.5	1.8	14.9	290
MRE-M2XCH-3T0.75	3×3×0.75	0.5	1.8	15.7	340
MRE-M2XCH-4T0.75	4×3×0.75	0.5	1.9	17.2	410
MRE-M2XCH-5T0.75	5×3×0.75	0.5	1.9	18.8	480
MRE-M2XCH-6T0.75	6×3×0.75	0.5	2.0	21.2	590
MRE-M2XCH-7T0.75	7×3×0.75	0.5	2.0	21.2	620
MRE-M2XCH-8T0.75	8×3×0.75	0.5	2.1	22.8	700
MRE-M2XCH-10T0.75	10×3×0.75	0.5	2.2	25.7	860
MRE-M2XCH-12T0.75	12×3×0.75	0.5	2.2	27.0	970
MRE-M2XCH-14T0.75	14×3×0.75	0.5	2.3	28.3	1080
MRE-M2XCH-16T0.75	16×3×0.75	0.5	2.3	29.9	1200
MRE-M2XCH-19T0.75	19×3×0.75	0.5	2.4	32.3	1390
MRE-M2XCH-20T0.75	20×3×0.75	0.5	2.5	33.0	1460
MRE-M2XCH-24T0.75	24×3×0.75	0.5	2.6	35.9	1710
MRE-M2XCH-30T0.75	30×3×0.75	0.5	2.9	40.1	2170
MRE-M2XCH-32T0.75	32×3×0.75	0.5	3.0	41.7	2320
MRE-M2XCH-1T1.0	1×3×1.0	0.5	1.3	9.9	150
MRE-M2XCH-2T1.0	2×3×1.0	0.5	1.8	15.6	320



Part No.	Construction No. of elements×No. of cores in element×Cross section(mm <sup>2</sup> )	Nominal Insulation Thickness mm	Nominal Sheath Thickness mm	Nominal Overall Diameter mm	Nominal Weight kg/km
MRE-M2XCH-3T1.0	3×3×1.0	0.5	1.8	16.5	380
MRE-M2XCH-4T1.0	4×3×1.0	0.5	1.9	18.1	470
MRE-M2XCH-5T1.0	5×3×1.0	0.5	2.0	20.1	560
MRE-M2XCH-6T1.0	6×3×1.0	0.5	2.1	22.6	680
MRE-M2XCH-7T1.0	7×3×1.0	0.5	2.1	22.6	720
MRE-M2XCH-8T1.0	8×3×1.0	0.5	2.1	24.1	810
MRE-M2XCH-10T1.0	10×3×1.0	0.5	2.2	27.2	990
MRE-M2XCH-12T1.0	12×3×1.0	0.5	2.3	28.8	1130
MRE-M2XCH-14T1.0	14×3×1.0	0.5	2.3	30.0	1260
MRE-M2XCH-16T1.0	16×3×1.0	0.5	2.4	31.9	1410
MRE-M2XCH-19T1.0	19×3×1.0	0.5	2.5	34.4	1640
MRE-M2XCH-20T1.0	20×3×1.0	0.5	2.5	35.0	1700
MRE-M2XCH-24T1.0	24×3×1.0	0.5	2.9	38.8	2110
MRE-M2XCH-30T1.0	30×3×1.0	0.5	3.0	42.8	2560
MRE-M2XCH-32T1.0	32×3×1.0	0.5	3.1	44.4	2730
MRE-M2XCH-1T1.5	1×3×1.5	0.6	1.3	11.0	180
MRE-M2XCH-2T1.5	2×3×1.5	0.6	1.9	17.7	410
MRE-M2XCH-3T1.5	3×3×1.5	0.6	1.9	18.7	490
MRE-M2XCH-4T1.5	4×3×1.5	0.6	2.0	20.6	610
MRE-M2XCH-5T1.5	5×3×1.5	0.6	2.1	22.9	740
MRE-M2XCH-6T1.5	6×3×1.5	0.6	2.2	25.8	890
MRE-M2XCH-7T1.5	7×3×1.5	0.6	2.2	25.8	950
MRE-M2XCH-8T1.5	8×3×1.5	0.6	2.3	27.7	1070
MRE-M2XCH-10T1.5	10×3×1.5	0.6	2.4	31.3	1320
MRE-M2XCH-12T1.5	12×3×1.5	0.6	2.5	33.2	1520
MRE-M2XCH-14T1.5	14×3×1.5	0.6	2.5	34.6	1690
MRE-M2XCH-16T1.5	16×3×1.5	0.6	2.8	37.3	1990
MRE-M2XCH-19T1.5	19×3×1.5	0.6	2.9	40.3	2310
MRE-M2XCH-20T1.5	20×3×1.5	0.6	3.0	41.1	2420
MRE-M2XCH-24T1.5	24×3×1.5	0.6	3.1	44.7	2840
MRE-M2XCH-30T1.5	30×3×1.5	0.6	3.3	49.5	3460
MRE-M2XCH-32T1.5	32×3×1.5	0.6	3.3	51.2	3670

\*: 2 pairs are assembled as a quad.





### **BFOI (i)/ BFOU (i) (MRE-M2XCH PiMF/TiMF)** **150/250V Mica Tape + XLPE Insulated, LSOH (SHF1) Sheathed,** **Individual Screened & Armoured Fire Resistant Instrumentation &** **Control Cables (Multipair/Multitriples)**

---

#### **Application**

These cables are used on board of ships in all locations for fixed installations complying with IEC standards 60092-352 in safety circuit, where fire resistance is required. These cables are fire resistant, flame retardant, low smoke & halogen free, suitable for installations on passenger ships, as on other commercial vessels.

#### **Standards**

- IEC 60092-350/360/376
- IEC 60331-21
- IEC 60332-1
- IEC 60332-3-22
- IEC 60754-1/2
- IEC 61034

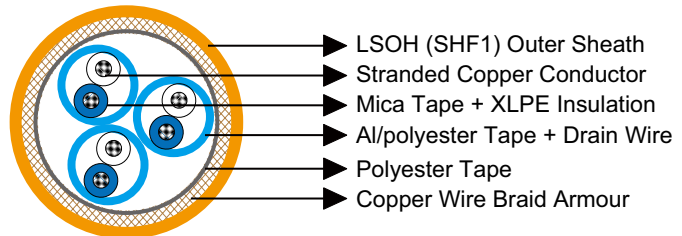

#### **Approvals:**

BV Certification(33493/B0 BV)

#### **Construction**

- Conductors: Class 2 stranded copper conductor.
- Insulation: Mica tape + XLPE.
- Cabling Element: Pair/Triple.
- Individual Screen: Al/polyester tape.
- Drain Wire: Tinned copper wire.
- Inner Covering: Lapped polyester tape.
- Armour: Copper wire braid.
- Outer Sheath: LSOH (SHF1). SHF2 can be offered upon request.





### Core Identification

Pair: White/blue with printed pair number and core number.

Triple: White/blue/red with printed triple number.

### Mechanical and Thermal Properties

Bending Radius for Fixed Installations:  $6 \times OD$

Temperature Range:  $-30^{\circ}\text{C} \sim +80^{\circ}\text{C}$

### Dimensions and Weight

Part No.	Construction No. of elements $\times$ No. of cores in element $\times$ Cross section (mm <sup>2</sup> )	Nominal Insulation Thickness mm	Nominal Sheath Thickness mm	Nominal Overall Diameter mm	Nominal Weight kg/km
MRE-M2XCH PiMF-1P0.75	1 $\times$ 2 $\times$ 0.75	0.5	1.3	9.3	130
MRE-M2XCH PiMF-2P0.75	2 $\times$ 2 $\times$ 0.75	0.5	1.4	13.6	230
MRE-M2XCH PiMF-3P0.75	3 $\times$ 2 $\times$ 0.75	0.5	1.8	15.1	320
MRE-M2XCH PiMF-4P0.75	4 $\times$ 2 $\times$ 0.75	0.5	1.8	16.0	370
MRE-M2XCH PiMF-5P0.75	5 $\times$ 2 $\times$ 0.75	0.5	1.9	17.9	450
MRE-M2XCH PiMF-6P0.75	6 $\times$ 2 $\times$ 0.75	0.5	1.9	19.1	510
MRE-M2XCH PiMF-7P0.75	7 $\times$ 2 $\times$ 0.75	0.5	1.9	19.1	540
MRE-M2XCH PiMF-8P0.75	8 $\times$ 2 $\times$ 0.75	0.5	2.0	20.4	610
MRE-M2XCH PiMF-10P0.75	10 $\times$ 2 $\times$ 0.75	0.5	2.1	22.9	740
MRE-M2XCH PiMF-12P0.75	12 $\times$ 2 $\times$ 0.75	0.5	2.1	23.7	830
MRE-M2XCH PiMF-14P0.75	14 $\times$ 2 $\times$ 0.75	0.5	2.1	24.6	910
MRE-M2XCH PiMF-16P0.75	16 $\times$ 2 $\times$ 0.75	0.5	2.2	26.5	1040
MRE-M2XCH PiMF-19P0.75	19 $\times$ 2 $\times$ 0.75	0.5	2.3	28.4	1200
MRE-M2XCH PiMF-20P0.75	20 $\times$ 2 $\times$ 0.75	0.5	2.3	28.4	1230
MRE-M2XCH PiMF-24P0.75	24 $\times$ 2 $\times$ 0.75	0.5	2.4	32.3	1490
MRE-M2XCH PiMF-30P0.75	30 $\times$ 2 $\times$ 0.75	0.5	2.5	35.1	1790
MRE-M2XCH PiMF-37P0.75	37 $\times$ 2 $\times$ 0.75	0.5	2.8	38.1	2200
MRE-M2XCH PiMF-1P1.0	1 $\times$ 2 $\times$ 1.0	0.5	1.3	9.7	140
MRE-M2XCH PiMF-2P1.0	2 $\times$ 2 $\times$ 1.0	0.5	1.8	15.0	300
MRE-M2XCH PiMF-3P1.0	3 $\times$ 2 $\times$ 1.0	0.5	1.8	15.9	360
MRE-M2XCH PiMF-4P1.0	4 $\times$ 2 $\times$ 1.0	0.5	1.9	17.0	430
MRE-M2XCH PiMF-5P1.0	5 $\times$ 2 $\times$ 1.0	0.5	1.9	18.8	510
MRE-M2XCH PiMF-6P1.0	6 $\times$ 2 $\times$ 1.0	0.5	2.0	20.3	600
MRE-M2XCH PiMF-7P1.0	7 $\times$ 2 $\times$ 1.0	0.5	2.0	20.3	630





# IEC Standard Caledonian Offshore & Marine Cables

## MariSig Fire Resistant Instrumentation & Control Cables

[www.caledonian-cables.co.uk](http://www.caledonian-cables.co.uk)

Part No.	Construction No. of elements×No. of cores in element×Cross section(mm <sup>2</sup> )	Nominal Insulation Thickness mm	Nominal Sheath Thickness mm	Nominal Overall Diameter mm	Nominal Weight kg/km
MRE-M2XCH PiMF-8P1.0	8×2×1.0	0.5	2.0	21.5	700
MRE-M2XCH PiMF-10P1.0	10×2×1.0	0.5	2.1	24.1	860
MRE-M2XCH PiMF-12P1.0	12×2×1.0	0.5	2.2	25.2	980
MRE-M2XCH PiMF-14P1.0	14×2×1.0	0.5	2.2	26.1	1080
MRE-M2XCH PiMF-16P1.0	16×2×1.0	0.5	2.3	28.2	1230
MRE-M2XCH PiMF-19P1.0	19×2×1.0	0.5	2.3	30.0	1410
MRE-M2XCH PiMF-20P1.0	20×2×1.0	0.5	2.3	30.0	1450
MRE-M2XCH PiMF-24P1.0	24×2×1.0	0.5	2.5	34.4	1780
MRE-M2XCH PiMF-30P1.0	30×2×1.0	0.5	2.8	37.8	2220
MRE-M2XCH PiMF-37P1.0	37×2×1.0	0.5	2.9	40.5	2620
MRE-M2XCH PiMF-1P1.5	1×2×1.5	0.6	1.3	10.7	170
MRE-M2XCH PiMF-2P1.5	2×2×1.5	0.6	1.9	16.9	380
MRE-M2XCH PiMF-3P1.5	3×2×1.5	0.6	1.9	17.9	450
MRE-M2XCH PiMF-4P1.5	4×2×1.5	0.6	1.9	19.0	530
MRE-M2XCH PiMF-5P1.5	5×2×1.5	0.6	2.0	21.3	650
MRE-M2XCH PiMF-6P1.5	6×2×1.5	0.6	2.1	23.0	750
MRE-M2XCH PiMF-7P1.5	7×2×1.5	0.6	2.1	23.0	800
MRE-M2XCH PiMF-8P1.5	8×2×1.5	0.6	2.1	24.4	890
MRE-M2XCH PiMF-10P1.5	10×2×1.5	0.6	2.3	27.6	1110
MRE-M2XCH PiMF-12P1.5	12×2×1.5	0.6	2.3	28.7	1250
MRE-M2XCH PiMF-14P1.5	14×2×1.5	0.6	2.3	29.7	1380
MRE-M2XCH PiMF-16P1.5	16×2×1.5	0.6	2.4	32.1	1580
MRE-M2XCH PiMF-19P1.5	19×2×1.5	0.6	2.5	34.4	1820
MRE-M2XCH PiMF-20P1.5	20×2×1.5	0.6	2.5	34.4	1870
MRE-M2XCH PiMF-24P1.5	24×2×1.5	0.6	2.9	39.9	2400
MRE-M2XCH PiMF-30P1.5	30×2×1.5	0.6	3.0	43.3	2870
MRE-M2XCH PiMF-37P1.5	37×2×1.5	0.6	3.2	46.6	3410
MRE-M2XCH TiMF-1T0.75	1×3×0.75	0.5	1.3	9.7	140
MRE-M2XCH TiMF-2T0.75	2×3×0.75	0.5	1.8	15.4	320
MRE-M2XCH TiMF-3T0.75	3×3×0.75	0.5	1.8	16.2	380
MRE-M2XCH TiMF-4T0.75	4×3×0.75	0.5	1.9	17.9	460
MRE-M2XCH TiMF-5T0.75	5×3×0.75	0.5	2.0	19.8	560
MRE-M2XCH TiMF-6T0.75	6×3×0.75	0.5	2.1	22.2	670
MRE-M2XCH TiMF-7T0.75	7×3×0.75	0.5	2.1	22.2	710
MRE-M2XCH TiMF-8T0.75	8×3×0.75	0.5	2.1	23.7	800
MRE-M2XCH TiMF-10T0.75	10×3×0.75	0.5	2.2	26.7	980
MRE-M2XCH TiMF-12T0.75	12×3×0.75	0.5	2.3	28.3	1120
MRE-M2XCH TiMF-14T0.75	14×3×0.75	0.5	2.3	29.4	1240
MRE-M2XCH TiMF-16T0.75	16×3×0.75	0.5	2.4	31.4	1400



Part No.	Construction No. of elements×No. of cores in element×Cross section(mm <sup>2</sup> )	Nominal Insulation Thickness mm	Nominal Sheath Thickness mm	Nominal Overall Diameter mm	Nominal Weight kg/km
MRE-M2XCH TIMF-19T0.75	19×3×0.75	0.5	2.5	33.9	1620
MRE-M2XCH TIMF-20T0.75	20×3×0.75	0.5	2.5	34.4	1680
MRE-M2XCH TIMF-24T0.75	24×3×0.75	0.5	2.8	37.9	2070
MRE-M2XCH TIMF-30T0.75	30×3×0.75	0.5	3.0	42.0	2520
MRE-M2XCH TIMF-32T0.75	32×3×0.75	0.5	3.0	43.4	2670
MRE-M2XCH TIMF-1T1.0	1×3×1.0	0.5	1.3	10.1	160
MRE-M2XCH TIMF-2T1.0	2×3×1.0	0.5	1.8	16.1	360
MRE-M2XCH TIMF-3T1.0	3×3×1.0	0.5	1.9	17.3	440
MRE-M2XCH TIMF-4T1.0	4×3×1.0	0.5	1.9	18.8	530
MRE-M2XCH TIMF-5T1.0	5×3×1.0	0.5	2.0	20.8	640
MRE-M2XCH TIMF-6T1.0	6×3×1.0	0.5	2.1	23.4	770
MRE-M2XCH TIMF-7T1.0	7×3×1.0	0.5	2.1	23.4	820
MRE-M2XCH TIMF-8T1.0	8×3×1.0	0.5	2.2	25.2	930
MRE-M2XCH TIMF-10T1.0	10×3×1.0	0.5	2.3	28.4	1150
MRE-M2XCH TIMF-12T1.0	12×3×1.0	0.5	2.3	29.9	1310
MRE-M2XCH TIMF-14T1.0	14×3×1.0	0.5	2.4	31.3	1470
MRE-M2XCH TIMF-16T1.0	16×3×1.0	0.5	2.5	33.4	1660
MRE-M2XCH TIMF-19T1.0	19×3×1.0	0.5	2.8	36.5	2010
MRE-M2XCH TIMF-20T1.0	20×3×1.0	0.5	2.8	37.1	2090
MRE-M2XCH TIMF-24T1.0	24×3×1.0	0.5	2.9	40.3	2450
MRE-M2XCH TIMF-30T1.0	30×3×1.0	0.5	3.1	44.7	3000
MRE-M2XCH TIMF-32T1.0	32×3×1.0	0.5	3.1	46.2	3180
MRE-M2XCH TIMF-1T1.5	1×3×1.5	0.6	1.4	11.4	200
MRE-M2XCH TIMF-2T1.5	2×3×1.5	0.6	1.9	18.2	450
MRE-M2XCH TIMF-3T1.5	3×3×1.5	0.6	2.0	19.5	560
MRE-M2XCH TIMF-4T1.5	4×3×1.5	0.6	2.0	21.3	670
MRE-M2XCH TIMF-5T1.5	5×3×1.5	0.6	2.1	23.6	820
MRE-M2XCH TIMF-6T1.5	6×3×1.5	0.6	2.2	26.6	990
MRE-M2XCH TIMF-7T1.5	7×3×1.5	0.6	2.2	26.6	1060
MRE-M2XCH TIMF-8T1.5	8×3×1.5	0.6	2.3	28.6	1200
MRE-M2XCH TIMF-10T1.5	10×3×1.5	0.6	2.4	32.3	1480
MRE-M2XCH TIMF-12T1.5	12×3×1.5	0.6	2.5	34.3	1700
MRE-M2XCH TIMF-14T1.5	14×3×1.5	0.6	2.6	35.9	1920
MRE-M2XCH TIMF-16T1.5	16×3×1.5	0.6	2.9	38.8	2260
MRE-M2XCH TIMF-19T1.5	19×3×1.5	0.6	3.0	41.8	2620
MRE-M2XCH TIMF-20T1.5	20×3×1.5	0.6	3.0	42.5	2720
MRE-M2XCH TIMF-24T1.5	24×3×1.5	0.6	3.1	46.2	3200
MRE-M2XCH TIMF-30T1.5	30×3×1.5	0.6	3.3	51.2	3910
MRE-M2XCH TIMF-32T1.5	32×3×1.5	0.6	3.4	53.2	4180





### BOI/ BOU (MRE-M3GCH)

150/250V Mica Tape + HEPR Insulated, LSOH (SHF1) Sheathed,

Armoured Fire Resistant Instrumentation & Control Cables

(Multipair)

### Application

These cables are used on board of ships in all locations for fixed installations complying with IEC standards 60092-352 in safety circuit, where fire resistance is required. These cables are fire resistant, flame retardant, low smoke & halogen free, suitable for installations on passenger ships, as on other commercial vessels.

### Standards

- DIN 89159
- IEC 60092-360/375
- IEC 60331-21
- IEC 60332-1
- IEC 60332-3-22
- IEC 60754-1/2
- IEC 61034

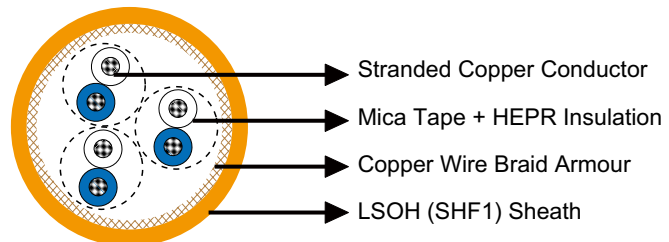

### Construction

- Conductors: Stranded copper conductor.
- Insulation: Mica tape + HEPR.
- Cabling Element: Pair.
- Armour: Copper wire braid.
- Outer Sheath: LSOH (SHF1).

### Core Identification

Pair: White/blue with printed pair number and core number.



### Mechanical and Thermal Properties

Bending Radius for Fixed Installations:  $6 \times OD$   
 Temperature Range:  $-30^{\circ}\text{C} \sim +75^{\circ}\text{C}$

### Dimensions and Weight

Part No.	Construction No. of elements $\times$ No. of cores in element $\times$ Cross section ( $\text{mm}^2$ )	Nominal Insulation Thickness mm	Nominal Sheath Thickness mm	Nominal Overall Diameter mm	Nominal Weight kg/km
MRE-M3GCH-1P0.75	1 $\times$ 2 $\times$ 0.75	0.5	1.2	10.5	110
MRE-M3GCH-2P0.75	2 $\times$ 2 $\times$ 0.75*	0.5	1.3	11.0	150
MRE-M3GCH-4P0.75	4 $\times$ 2 $\times$ 0.75	0.5	1.4	16.0	270
MRE-M3GCH-7P0.75	7 $\times$ 2 $\times$ 0.75	0.5	1.8	19.0	400
MRE-M3GCH-10P0.75	10 $\times$ 2 $\times$ 0.75	0.5	1.9	22.0	560
MRE-M3GCH-14P0.75	14 $\times$ 2 $\times$ 0.75	0.5	2.0	27.0	740
MRE-M3GCH-19P0.75	19 $\times$ 2 $\times$ 0.75	0.5	2.1	29.0	930
MRE-M3GCH-24P0.75	24 $\times$ 2 $\times$ 0.75	0.5	2.2	31.0	1110

\*: 2 pairs are assembled as a quad.





### Cat 5e S/FTP 0.22mm<sup>2</sup>

#### Application

These Cat5e S/FTP cables are manufactured in accordance with IEC 61156-5 requirements, can support all Class D applications like Ethernet, Fast Ethernet, Gigabit Ethernet, suitable for basic voice and data installations up to 100MHz.

#### Standards

- EN 50173-1
- EN 50288-2-1
- ISO/IEC 11801
- IEC 61156-5
- IEC 60332-3-24
- IEC 60754-1/2
- IEC 61034-1/2

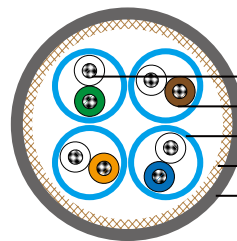

- ▶ Stranded Copper Conductor
- ▶ PE Insulation
- ▶ Al/polyester Tape
- ▶ Tinned Copper Braid
- ▶ LSOH (SHF1) Outer Sheath



#### Approvals:

BV Certification(33493/B0 BV)

#### Construction

- Conductors: Stranded copper conductor.
- Insulation: PE.
- Twinning: Two coloured insulated conductors twisted together to form a pair.
- Individual Screen: Al/polyester tape.
- Overall Screen: Tinned copper wire braid.
- Outer Sheath: Oil resistant, flame retardant and halogen free LSOH (SHF1).

#### Core Identification

- Pair 1: White, Blue
- Pair 2: White, Orange
- Pair 3: White, Green
- Pair 4: White, Brown



### Electrical Properties

Maximum DC Loop Resistance	Ω/km	158
Maximum Resistance Unbalance		2%
Minimum Insulation Resistance (500V)	MΩ.km	5000
Nominal Capacitance @800Hz	nF/km	43
Maximum Capacitance Unbalance (pair to ground)	pF/km	1500
Mean Characteristic Impedance @100MHz	Ω	100 ± 5
Nominal Velocity of Propagation		0.75c
Maximum Propagation Delay	ns/100 m	450
Maximum Delay Skew	ns/100 m	15
Maximum Transfer Impedance @1MHz	mΩ /m	10
Maximum Transfer Impedance @10MHz	mΩ /m	8
Maximum Transfer Impedance @30MHz	mΩ /m	10
Minimum Coupling Attenuation	dB	85

### Nominal Transmission Characteristics @20 °C

F MHz	Attenuation dB/100m	NEXT dB	ACR dB/100m	Return Loss dB	PS-NEXT dB	PS-ACR dB/100m	ELFEXT dB/100m	PS-ELFEXT dB/100m
1	2.1	90	88		87	85	85	82
4	4.0	90	86	27	87	83	85	82
10	6.3	90	84	30	87	81	79	76
16	8.0	90	82	30	87	79	75	72
20	9.0	90	81	30	87	78	73	70
31.25	11.4	90	79	30	87	76	69	66
62.5	16.5	86	70	30	83	67	63	60
100	21.3	83	62	30	80	59	59	56
155.0	24.2	81	57	26	78	54	57	54
200.0	31.5	78	47	25	75	44	53	50
250	35.8	77	41	25	74	38	51	48
300.0	47.1	73	26	23	70	23	47	44
600.0	60.1	71	11	20	68	8	44	41

### Mechanical and Thermal Properties

Bending Radius: 8 × OD (during installation); 4 × OD (fixed installed)

Temperature Range: -40 °C ~ +85 °C

### Dimensions and Weight

Part No.	Construction No. of elements×No. of cores in element×Cross section(mm <sup>2</sup> )	Nominal Insulation Thickness mm	Nominal Sheath Thickness mm	Nominal Overall Diameter mm	Nominal Weight kg/km
MLN-S/FTPCAT5E4P22S	4×2×0.22	0.4	0.75	7.7	68



## Mud Resistant Cat 5e S/FTP 0.22mm<sup>2</sup>

### Application

These Cat5e S/FTP cables are manufactured in accordance with IEC 61156-5 requirements, can support all Class D applications like Ethernet, Fast Ethernet, Gigabit Ethernet, suitable for basic voice and data installations up to 100MHz. These cables have additional flame retardant, halogen-free, low smoke MUD protecting outer sheaths.

### Standards

- EN 50173-1
- EN 50288-2-1
- ISO/IEC 11801
- IEC 61156-5
- IEC 60332-3-24
- IEC 60754-1/2
- IEC 61034-1/2



#### Approvals:

BV Certification(33493/B0 BV)

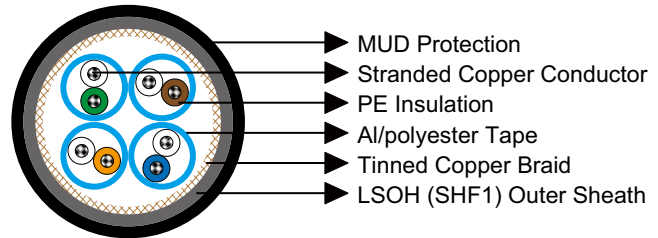

### Construction

- Conductors: Stranded copper conductor.
- Insulation: PE.
- Twining: Two coloured insulated conductors twisted together to form a pair.
- Individual Screen: Al/polyester tape.
- Overall Screen: Tinned copper wire braid.
- Inner Sheath: Oil resistant, flame retardant and halogen free LSOH (SHF1).
- Outer Sheath: MUD protecting.

### Core Identification

Pair 1: White, Blue





Pair 2: White, Orange

Pair 3: White, Green

Pair 4: White, Brown

### Electrical Properties

Maximum DC Loop Resistance	Ω/km	158
Maximum Resistance Unbalance		2%
Minimum Insulation Resistance (500V)	MΩ.km	5000
Nominal Capacitance @800Hz	nF/km	43
Maximum Capacitance Unbalance (pair to ground)	pF/km	1500
Mean Characteristic Impedance @100MHz	Ω	100 ± 5
Nominal Velocity of Propagation		0.75c
Maximum Propagation Delay	ns/100 m	450
Maximum Delay Skew	ns/100 m	15
Maximum Transfer Impedance @1MHz	mΩ /m	10
Maximum Transfer Impedance @10MHz	mΩ /m	8
Maximum Transfer Impedance @30MHz	mΩ /m	10
Minimum Coupling Attenuation	dB	85

### Nominal Transmission Characteristics @20°C

F MHz	Attenuation dB/100m	NEXT dB	ACR dB/100m	Return Loss dB	PS-NEXT dB	PS-ACR dB/100m	ELFEXT dB/100m	PS-ELFEXT dB/100m
1	2.1	90	88		87	85	85	82
4	4.0	90	86	27	87	83	85	82
10	6.3	90	84	30	87	81	79	76
16	8.0	90	82	30	87	79	75	72
20	9.0	90	81	30	87	78	73	70
31.25	11.4	90	79	30	87	76	69	66
62.5	16.5	86	70	30	83	67	63	60
100	21.3	83	62	30	80	59	59	56
155.0	24.2	81	57	26	78	54	57	54
200.0	31.5	78	47	25	75	44	53	50
250	35.8	77	41	25	74	38	51	48
300.0	47.1	73	26	23	70	23	47	44
600.0	60.1	71	11	20	68	8	44	41

### Mechanical and Thermal Properties

Bending Radius: 8 × OD (during installation); 4 × OD (fixed installed)

Temperature Range: -40°C ~ +85°C

### Dimensions and Weight

Part No.	Construction No. of elements×No. of cores in element×Cross section(mm <sup>2</sup> )	Nominal Insulation Thickness mm	Nominal Sheath Thickness mm		Nominal Overall Diameter mm	Nominal Weight kg/km
			Inner	Outer		
MLN-S/FTPCAT5EM4P22S	4×2×0.22	0.4	0.75	0.9	9.5	100





### Cat 5e SF/UTP 24AWG 4P/8P

### Application

These Cat5e SF/UTP cables are manufactured in accordance with IEC 61156-5 requirements, can support all Class D applications like Ethernet, Fast Ethernet, Gigabit Ethernet, suitable for basic voice and data installations up to 100MHz.

### Standards

- EN 50173-1
- EN 50288-2-1
- ISO/IEC 11801
- IEC 61156-5
- TIA/EIA-568-B.2
- IEC 60332-1 (for PVC & LSOH & FRLSOH Sheath)
- IEC 60754-2 (for LSOH & FRLSOH Sheath)
- IEC 61034 (for LSOH & FRLSOH Sheath)
- IEC 60332-3-24 (for FRLSOH Sheath)

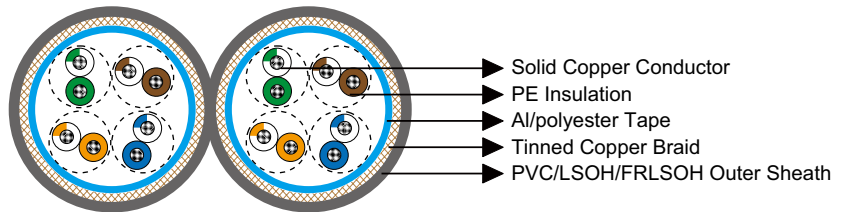
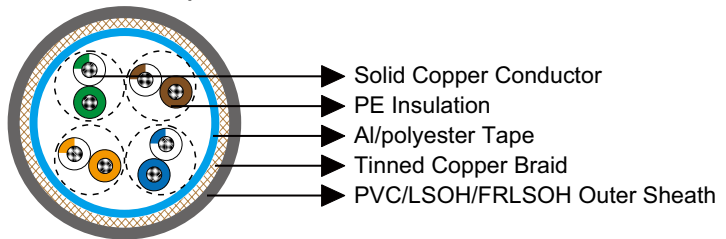

### Approvals:

BV Certification(33493/B0 BV)

### Construction

- Conductors: Bare copper conductor.
- Insulation: PE.
- Twining: Two coloured insulated conductors twisted together to form a pair.
- Overall Screen1: Al/polyester tape.
- Overall Screen2: Tinned copper wire braid.
- Outer Sheath: PVC/LSOH/FRLSOH.

### Core Identification

- Pair 1: White/Blue, Blue
- Pair 2: White/Orange, Orange
- Pair 3: White/Green, Green
- Pair 4: White/Brown, Brown



### Electrical Properties

Maximum Loop Resistance	Ω/km	190
Maximum Resistance Unbalance		2%
Minimum Insulation Resistance	MΩ.km	1000
Nominal Capacitance @800Hz	nF/km	48
Maximum Capacitance Unbalance (pair to ground)	pF/km	1500
Characteristic Impedance @1-100MHz	Ω	100 ± 15
Nominal Velocity of Propagation		ca. 67%
Maximum Propagation Delay	ns/100 m	535
Maximum Delay Skew	ns/100 m	20
Maximum Transfer Impedance @1MHz	mΩ /m	20
Maximum Transfer Impedance @10MHz	mΩ /m	20
Maximum Transfer Impedance @30MHz	mΩ /m	30
Maximum Transfer Impedance @100MHz	mΩ /m	60
Minimum Coupling Attenuation	dB	75

### Nominal Transmission Characteristics @20°C

F MHz	Attenuation dB/100m	NEXT dB	PS-NEXT dB	ACR dB/100m	PS-ACR dB/100m	ELFEXT dB/100m	PS-ELFEXT dB/100m	Return Loss dB
1	1.9	71	68	69.1	66.1	68	65	20
4	3.7	62	59	58.3	55.3	56	53	23
10	6.0	56	53	50	47.0	48	45	25
16	7.6	53	50	45.4	42.4	44	41	25
20	8.5	51	48	42.5	39.5	42	39	25
31.2	10.7	49	46	38.3	35.3	38	35	24
62.5	15.7	44	41	28.2	25.3	32	29	22
100	19.8	41	38	21.2	18.2	28	25	20
125.0	22.3	40	37	17.7	14.7	26	23	19
155.5	24.2	38	35	13.8	10.8	24	21	
175.0	25.7	37	34	11.3	8.3	23	20	
200.0	27.5	36	33	8.5	5.5	22	19	
250.0	29.2	35	32	5.8	2.8	20	17	
300.0	32.0	34	31	2.0	-1.0	16	13	

### Mechanical and Thermal Properties

Bending Radius: 8 × OD (during installation); 4 × OD (fixed installed)

Temperature Range: -20°C ~ +60°C

### Dimensions and Weight

Part No.	Construction No. of elements×No. of cores in element×Cross section(mm <sup>2</sup> )	Nominal Insulation Thickness mm	Nominal Sheath Thickness mm	Nominal Overall Diameter mm	Nominal Weight kg/km
MLN-SF/UTPCAT5E4P24	4×2×24AWG	0.29	0.6	6.4	47
MLN-SF/UTPCAT5E8P24	2×(4×2×24AWG)	0.29	0.6	13.0×6.4	94





### Armoured Cat 5e SF/UTP 24AWG

#### Application

These Cat5e SF/UTP cables are manufactured in accordance with IEC 61156-5 requirements, can support all Class D applications like Ethernet, Fast Ethernet, Gigabit Ethernet, suitable for basic voice and data installations up to 100MHz.

#### Standards

- EN 50288
- ISO 11801
- IEC 61156-5
- IEC 60332-1
- IEC 60754-1/2
- IEC 61034

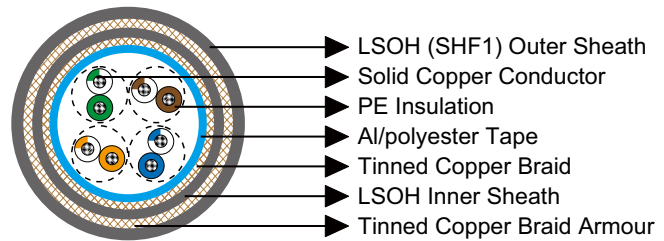

#### Approvals:

BV Certification(33493/B0 BV)

#### Construction

- Conductors: Bare copper conductor.
- Insulation: PE.
- Twining: Two coloured insulated conductors twisted together to form a pair.
- Overall Screen1: Al/polyester tape.
- Overall Screen2: Tinned copper wire braid.
- Inner Sheath: LSOH.
- Armour: Tinned copper wire braid.
- Outer Sheath: LSOH (SHF1).

#### Core Identification

- Pair 1: White/Blue, Blue
- Pair 2: White/Orange, Orange
- Pair 3: White/Green, Green
- Pair 4: White/Brown, Brown



### Electrical Properties

Maximum Loop Resistance	Ω/km	190
Maximum Resistance Unbalance		2%
Minimum Insulation Resistance	MΩ.km	1000
Nominal Capacitance @800Hz	nF/km	48
Maximum Capacitance Unbalance (pair to ground)	pF/km	1500
Characteristic Impedance @1-100MHz	Ω	100 ± 15
Nominal Velocity of Propagation		ca. 67%
Maximum Propagation Delay	ns/100 m	535
Maximum Delay Skew	ns/100 m	20
Maximum Transfer Impedance @1MHz	mΩ /m	20
Maximum Transfer Impedance @10MHz	mΩ /m	20
Maximum Transfer Impedance @30MHz	mΩ /m	30
Maximum Transfer Impedance @100MHz	mΩ /m	60
Minimum Coupling Attenuation	dB	75

### Nominal Transmission Characteristics @20°C

F MHz	Attenuation dB/100m	NEXT dB	PS-NEXT dB	ACR dB/100m	PS-ACR dB/100m	ELFEXT dB/100m	PS-ELFEXT dB/100m	Return Loss dB
1	1.9	71	68	69.1	66.1	68	65	20
4	3.7	62	59	58.3	55.3	56	53	23
10	6.0	56	53	50	47.0	48	45	25
16	7.6	53	50	45.4	42.4	44	41	25
20	8.5	51	48	42.5	39.5	42	39	25
31.2	10.7	49	46	38.3	35.3	38	35	24
62.5	15.7	44	41	28.2	25.3	32	29	22
100	19.8	41	38	21.2	18.2	28	25	20
125.0	22.3	40	37	17.7	14.7	26	23	19
155.5	24.2	38	35	13.8	10.8	24	21	
175.0	25.7	37	34	11.3	8.3	23	20	
200.0	27.5	36	33	8.5	5.5	22	19	
250.0	29.2	35	32	5.8	2.8	20	17	
300.0	32.0	34	31	2.0	-1.0	16	13	

### Mechanical and Thermal Properties

Bending Radius: 8 × OD (during installation); 4 × OD (fixed installed)

Temperature Range: -20°C ~ +60°C

### Dimensions and Weight

Part No.	Construction No. of elements×No. of cores in element×Cross section(mm²)	Nominal Insulation Thickness mm	Nominal Sheath Thickness mm		Nominal Overall Diameter mm	Nominal Weight kg/km
			Inner	Outer		
MLN-SF/UTPCAT5E4P24 CWB	4×2×24AWG	0.25	0.74	1.22	10.5	173





### Cat 5e F/UTP 24AWG

#### Application

These Cat5e F/UTP cables are manufactured in accordance with IEC 61156-5 requirements, can support all Class D applications like Ethernet, Fast Ethernet, Gigabit Ethernet, suitable for basic voice and data installations up to 100MHz.

#### Standards

- EN 50288
- ISO 11801
- IEC 61156-5
- IEC 60332-1
- IEC 60754-1/2
- IEC 61034

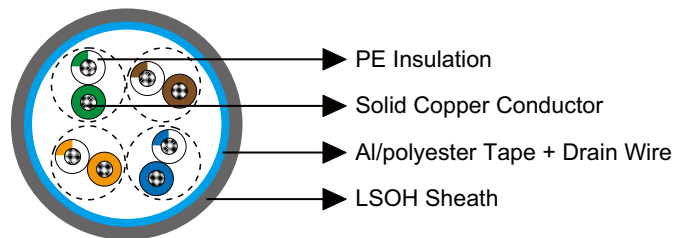

#### Approvals:

BV Certification(33493/B0 BV)

#### Construction

- Conductors: Solid bare copper conductor.
- Insulation: PE.
- Twining: Two coloured insulated conductors twisted together to form a pair.
- Overall Screen: Al/polyester tape.
- Drain Wire: Tinned copper wire.
- Outer Sheath: LSOH.

#### Core Identification

Pair 1: White/Blue, Blue  
Pair 2: White/Orange, Orange  
Pair 3: White/Green, Green  
Pair 4: White/Brown, Brown

#### Electrical Properties

# IEC Standard Caledonian Offshore & Marine Cables



## MariLan Marine Lan Data & Communication Cables

www.caledonian-cables.co.uk

Maximum Loop Resistance	Ω/km	190
Maximum Resistance Unbalance		2%
Minimum Insulation Resistance	MΩ.km	1000
Nominal Capacitance @800Hz	nF/km	48
Maximum Capacitance Unbalance (pair to ground)	pF/km	1500
Characteristic Impedance @1-100MHz	Ω	100 ± 15
Nominal Velocity of Propagation		ca. 67%
Maximum Propagation Delay	ns/100 m	535
Maximum Delay Skew	ns/100 m	20
Maximum Transfer Impedance @1MHz	mΩ /m	50
Maximum Transfer Impedance @10MHz	mΩ /m	100
Maximum Transfer Impedance @30MHz	mΩ /m	200
Minimum Coupling Attenuation	dB	55

### Nominal Transmission Characteristics @20°C

F MHz	Attenuation dB/100m	NEXT dB	PS-NEXT dB	ACR dB/100m	PS-ACR dB/100m	ELFEXT dB/100m	PS-ELFEXT dB/100m	Return Loss dB
1	1.9	71	68	69.1	66.1	68	65	20
4	3.7	62	59	58.3	55.3	56	53	23
10	6.0	56	53	50	47.0	48	45	25
16	7.6	53	50	45.4	42.4	44	41	25
20	8.5	51	48	42.5	39.5	42	39	25
31.2	10.7	49	46	38.3	35.3	38	35	24
62.5	15.7	44	41	28.2	25.3	32	29	22
100	19.8	41	38	21.2	18.2	28	25	20
125.0	22.3	40	37	17.7	14.7	26	23	19
155.5	24.2	38	35	13.8	10.8	24	21	
175.0	25.7	37	34	11.3	8.3	23	20	
200.0	27.5	36	33	8.5	5.5	22	19	
250.0	29.2	35	32	5.8	2.8	20	17	
300.0	32.0	34	31	2.0	-1.0	16	13	

### Mechanical and Thermal Properties

Bending Radius: 8 × OD (during installation); 4 × OD (fixed installed)  
 Temperature Range: -20°C ~ +60°C

### Dimensions and Weight

Part No.	Construction No. of elements×No. of cores in element×Cross section(mm <sup>2</sup> )	Nominal Insulation Thickness mm	Nominal Sheath Thickness mm	Nominal Overall Diameter mm	Nominal Weight kg/km
MLN-F/UTPCAT5E4P24	4×2×24AWG	0.25	0.75	6.97	54



### Cat 6 U/FTP 23AWG

### Application

These Cat6 U/FTP cables are manufactured in accordance with IEC 61156-5 requirements, can support all Class E applications like Ethernet, Fast Ethernet, Gigabit Ethernet, suitable for basic voice and data installations up to 250MHz.

### Standards

- EN 50288
- ISO 11801
- IEC 61156-5
- IEC 60332-1
- IEC 60754-1/2
- IEC 61034

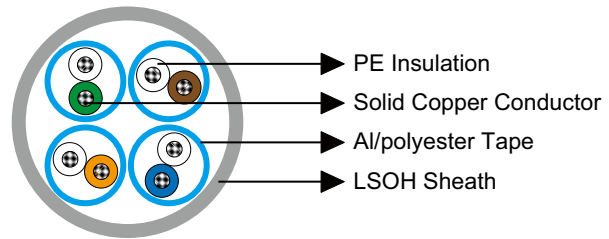

#### Approvals:

BV Certification(33493/B0 BV)

### Construction

- Conductors: Solid bare copper conductor.
- Insulation: PE.
- Twinning: Two coloured insulated conductors twisted together to form a pair.
- Individual Screen: Al/polyester tape.
- Outer Sheath: LSOH.

### Core Identification

- Pair 1: White, Blue
- Pair 2: White, Orange
- Pair 3: White, Green
- Pair 4: White, Brown

### Electrical Properties

Maximum Loop Resistance	Ω/km	145
Maximum Resistance Unbalance		2%





Minimum Insulation Resistance	MΩ.km	1000
Nominal Capacitance @800Hz	nF/km	45
Maximum Capacitance Unbalance (pair to ground)	pF/km	800
Characteristic Impedance @1-100MHz	Ω	100 ± 5
Nominal Velocity of Propagation		0.75c
Maximum Propagation Delay	ns/100 m	500
Maximum Delay Skew	ns/100 m	20
Maximum Transfer Impedance @1MHz	mΩ /m	50
Maximum Transfer Impedance @10MHz	mΩ /m	100
Maximum Transfer Impedance @30MHz	mΩ /m	200
Minimum Coupling Attenuation	dB	55

### Nominal Transmission Characteristics @20°C

F	Attenuation	NEXT	PS-NEXT	ACR	PS-ACR	ELFEXT	PS-ELFEXT	Return Loss
MHz	dB/100m	dB	dB	dB/100m	dB/100m	dB/100m	dB/100m	dB
1	2.0	90	87	88	85	85	82	
4	3.6	90	87	86	83	85	82	27
10	5.7	90	87	84	81	79	76	30
16	7.2	90	87	83	80	75	72	30
20	8.1	90	87	82	79	73	70	30
31.25	10.2	90	87	80	77	69	66	30
62.50	14.7	90	87	75	72	63	60	30
100	18.9	90	87	71	68	59	56	30
155	24.0	88	85	64	61	55	52	26
200	27.0	88	85	61	58	53	50	25
250	31.4	86	83	55	52	51	48	25
300	34.8	86	83	51	48	49	46	23
400	38.1	86	83	48	45	44	41	23

### Mechanical and Thermal Properties

Bending Radius: 8 × OD (during installation); 4 × OD (fixed installed)

Temperature Range: -20°C ~ +60°C

### Dimensions and Weight

Part No.	Construction No. of elements×No. of cores in element×Cross section(mm²)	Nominal Insulation Thickness mm	Nominal Sheath Thickness mm	Nominal Overall Diameter mm	Nominal Weight kg/km
MLN-U/FTPCAT64P23	4×2×23AWG	0.23	0.63	7.5	61





### Armoured Cat 6 S/FTP 23AWG

#### Application

These Cat6 S/FTP cables are manufactured in accordance with IEC 61156-5 requirements, can support all Class E applications like Ethernet, Fast Ethernet, Gigabit Ethernet, suitable for basic voice and data installations up to 250MHz.

#### Standards

- EN 50288
- ISO 11801
- IEC 61156-5
- IEC 60332-1
- IEC 60754-1/2
- IEC 61034

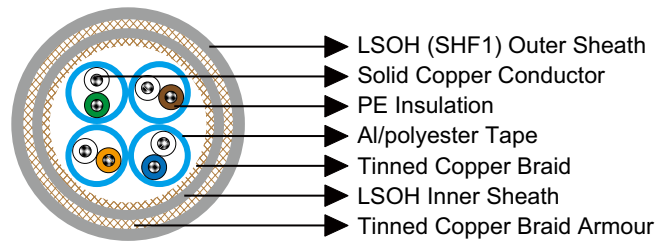

#### Approvals:

BV Certification(33493/B0 BV)

#### Construction

- Conductors: Solid bare copper conductor.
- Insulation: PE.
- Twinning: Two coloured insulated conductors twisted together to form a pair.
- Individual Screen: Al/polyester tape.
- Overall Screen: Tinned copper braid.
- Inner Sheath: LSOH.
- Armour: Tinned copper braid.
- Outer Sheath: LSOH (SHF1).

#### Core Identification

- Pair 1: White,Blue
- Pair 2: White,Orange
- Pair 3: White,Green
- Pair 4: White,Brown



### Electrical Properties

Maximum DC Loop Resistance	Ω/km	165
Maximum Resistance Unbalance		2%
Minimum Insulation Resistance	MΩ.km	1000
Nominal Capacitance @800Hz	nF/km	43
Maximum Capacitance Unbalance (pair to ground)	pF/km	1500
Characteristic Impedance @1-100MHz	Ω	100 ± 15
Nominal Velocity of Propagation		79%
Maximum Propagation Delay	ns/100 m	427
Maximum Delay Skew	ns/100 m	12
Maximum Transfer Impedance @1MHz	mΩ /m	5
Maximum Transfer Impedance @10MHz	mΩ /m	10
Maximum Transfer Impedance @30MHz	mΩ /m	30
Maximum Transfer Impedance @100MHz	mΩ /m	100

### Nominal Transmission Characteristics @20°C

F MHz	Attenuation dB/100m	NEXT dB	PS-NEXT dB	ACR dB/100m	PS-ACR dB/100m	ELFEXT dB/100m	PS-ELFEXT dB/100m	Return Loss dB
1	2.0	90	87	88	85	85	82	
4	3.6	90	87	86	83	85	82	27
10	5.7	90	87	84	81	79	76	30
16	7.2	90	87	83	80	75	72	30
20	8.1	90	87	82	79	73	70	30
31.25	10.2	90	87	80	77	69	66	30
62.50	14.7	90	87	75	72	63	60	30
100	18.9	90	87	71	68	59	56	30
155	24.0	88	85	64	61	55	52	26
200	27.0	88	85	61	58	53	50	25
250	31.4	86	83	55	52	51	48	25
300	34.8	86	83	51	48	49	46	23
400	38.1	86	83	48	45	44	41	23

### Mechanical and Thermal Properties

Bending Radius: 8 × OD (during installation); 4 × OD (fixed installed)

Temperature Range: -20°C ~ +60°C

### Dimensions and Weight

Part No.	Construction No. of elements×No. of cores in element×Cross section(mm <sup>2</sup> )	Nominal Insulation Thickness mm	Nominal Sheath Thickness mm		Nominal Overall Diameter mm	Nominal Weight kg/km
			Inner	Outer		
MLN-S/FTPCAT64P23 CWB	4×2×23AWG	0.578	0.60	1.09	10.78	188





### Cat 6 SF/UTP 24AWG 4P/8P

#### Application

These Cat6 SF/UTP cables are manufactured in accordance with IEC 61156-5 requirements, can support all Class E applications like Ethernet, Fast Ethernet, Gigabit Ethernet, suitable for basic voice and data installations up to 250MHz.

#### Standards

- EN 50288
- ISO 11801
- IEC 61156-5
- IEC 60332-1
- IEC 60754-1/2
- IEC 61034

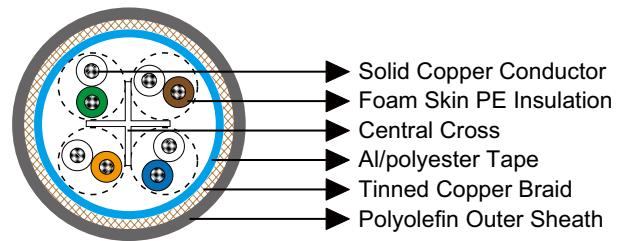

#### Approvals:

BV Certification(33493/B0 BV)

#### Construction

- Central Cross
- Conductors: Solid bare copper conductor.
- Insulation: Foam skin PE.
- Twining: Two coloured insulated conductors twisted together to form a pair.
- Overall Screen1: Al/polyester tape.
- Overall screen2: Tinned copper wire braid.
- Outer Sheath: Polyolefin.

#### Core Identification

Pair 1: White, Blue  
Pair 2: White, Orange  
Pair 3: White, Green  
Pair 4: White, Brown



### Electrical Properties

Minimum Insulation Resistance	MΩ.km	1000
Mutual Capacitance	nF/km	56
Characteristic Impedance @1-100MHz	Ω	100 ± 15
Nominal Velocity of Propagation	%	67
Maximum Propagation Delay	ns/100 m	537.6
Maximum Delay Skew	ns/100 m	45
Coupling Attenuation @30MHz	dB	75

### Nominal Transmission Characteristics @20°C

F MHz	Attenuation dB/100m	NEXT dB	PS-NEXT dB	ACR dB/100m	ELFEXT dB/100m	PS-ELFEXT dB/100m	Return Loss dB
1	2.1	80.3	77.3	78.2	71.0	68.0	21.5
4	3.8	71.3	68.3	67.4	59.0	56.0	24.5
10	6.0	65.3	62.3	59.3	51.0	48.0	26.5
16	7.6	62.2	59.2	54.6	46.9	43.9	26.5
20	8.5	60.8	57.8	52.3	45.0	42.0	26.5
31.25	10.7	57.9	54.9	47.1	41.1	38.1	25.1
62.50	15.5	53.4	50.4	37.9	35.1	32.1	23.0
100	19.9	50.3	47.3	30.4	31.0	28.0	21.6
155	25.3	47.4	44.4	22.1	27.2	24.2	20.3
200	29.1	45.8	42.8	16.6	25.0	22.0	19.5
250	33.0	44.3	41.3	11.3	23.0	20.0	18.8

### Mechanical and Thermal Properties

Bending Radius: 8 × OD (during installation); 4 × OD (fixed installed)

Temperature Range: -20°C ~ +60°C

### Dimensions and Weight

Part No.	Construction No. of elements×No. of cores in element×Cross section(mm <sup>2</sup> )	Nominal Insulation Thickness mm	Nominal Sheath Thickness mm	Nominal Overall Diameter mm	Nominal Weight kg/km
MLN-SF/UTPCAT64P24	4×2×24AWG	0.31	1.2	7.6	60
MLN-SF/UTPCAT68P24	2×(4×2×24AWG)	0.31	1.2	15.2×7.6	120





### Cat 7 S/FTP 0.27 mm<sup>2</sup>

### Application

These Cat7 S/FTP cables are manufactured in accordance with IEC 61156-5 requirements, can support all Class F applications like Ethernet, Fast Ethernet, Gigabit Ethernet, suitable for voice, data, CATV and sharing application installations up to 600MHz.

### Standards

- EN 50173-1
- EN 50288-4-1
- ISO/IEC 11801
- IEC 61156-5
- IEC 60332-3-24
- IEC 60754-2
- IEC 61034

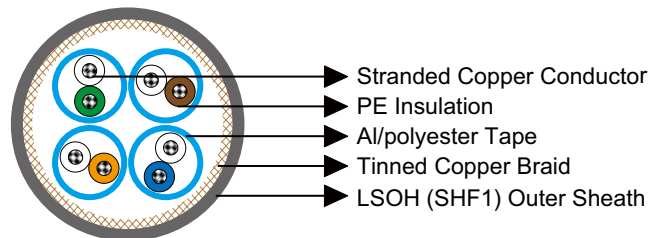

### Approvals:

BV Certification(33493/B0 BV)

### Construction

- Conductors: Stranded copper conductor.
- Insulation: PE.
- Twining: Two coloured insulated conductors twisted together to form a pair.
- Individual Screen: Al/polyester tape.
- Overall Screen: Tinned copper wire braid.
- Outer Sheath: Oil resistant, flame retardant and halogen free LSOH (SHF1).

### Core Identification

Pair 1: White, Blue  
Pair 2: White, Orange  
Pair 3: White, Green  
Pair 4: White, Brown



### Electrical Properties

Maximum DC Loop Resistance	Ω/km	138
Maximum Resistance Unbalance		2%
Minimum Insulation Resistance (500V)	MΩ.km	5000
Nominal Capacitance @800Hz	nF/km	43
Maximum Capacitance Unbalance (pair to ground)	pF/km	1500
Mean Characteristic Impedance @100MHz	Ω	100 ± 5
Nominal Velocity of Propagation		0.76c
Maximum Propagation Delay	ns/100 m	450
Maximum Delay Skew	ns/100 m	15
Maximum Transfer Impedance @1MHz	mΩ /m	10
Maximum Transfer Impedance @10MHz	mΩ /m	8
Maximum Transfer Impedance @30MHz	mΩ /m	10
Minimum Coupling Attenuation	dB	85

### Nominal Transmission Characteristics @20°C

F	Attenuation	NEXT	ACR	Return Loss	PS-NEXT	PS-ACR	ELFEXT	PS-ELFEXT
MHz	dB/100m	dB	dB/100m	dB	dB	dB/100m	dB/100m	dB/100m
1	2.0	90	88		87	85	85	82
4	3.6	90	86	27	87	83	85	82
10	5.5	90	84	30	87	81	79	76
16	7.5	90	82	30	87	79	75	72
20	7.7	90	82	30	87	79	73	70
31.25	9.8	90	80	30	87	77	69	66
62.5	14.0	86	72	30	83	69	63	60
100	17.9	83	65	30	80	62	59	56
155.0	22.4	81	59	26	78	55	57	54
200.0	25.6	78	52	25	75	49	53	50
250.0	28.8	77	48	25	74	45	51	48
300.0	31.6	73	41	23	70	38	47	44
600.0	45.7	71	25	20	68	22	44	41

### Mechanical and Thermal Properties

Bending Radius: 8 × OD (during installation); 4 × OD (fixed installed)

Temperature Range: -40°C ~ +85°C

### Dimensions and Weight

Part No.	Construction No. of elements×No. of cores in element×Cross section(mm <sup>2</sup> )	Nominal Insulation Thickness mm	Nominal Sheath Thickness mm	Nominal Overall Diameter mm	Nominal Weight kg/km
MLN-S/FTPCAT74P27S	4×2×0.27	0.47	0.75	8.1	75



### Mud Resistant Cat 7 S/FTP 0.27 mm<sup>2</sup>

#### Application

These Cat7 S/FTP cables are manufactured in accordance with IEC 61156-5 requirements, can support all Class F applications like Ethernet, Fast Ethernet, Gigabit Ethernet, suitable for voice, data, CATV and sharing application installations up to 600MHz. These cables have additional flame retardant, halogen-free, low smoke MUD protecting outer sheaths.

#### Standards

- EN 50173-1
- EN 50288-4-1
- ISO/IEC 11801
- IEC 61156-5
- IEC 60332-3-24
- IEC 60754-2
- IEC 61034

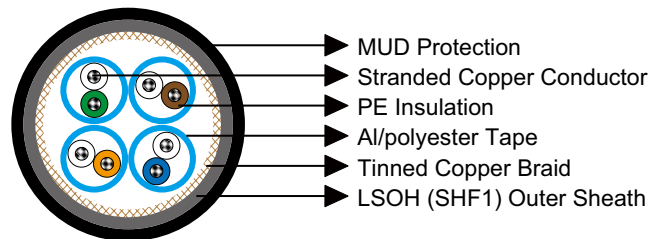

#### Approvals:

BV Certification(33493/B0 BV)

#### Construction

- Conductors: Stranded copper conductor.
- Insulation: PE.
- Twinning: Two coloured insulated conductors twisted together to form a pair.
- Individual Screen: Al/polyester tape.
- Overall Screen: Tinned copper wire braid.
- Inner Sheath: Oil resistant, flame retardant and halogen free LSOH (SHF1).
- Outer Sheath: MUD protecting.

#### Core Identification

Pair 1: White, Blue  
Pair 2: White, Orange  
Pair 3: White, Green  
Pair 4: White, Brown





### Electrical Properties

Maximum DC Loop Resistance	Ω/km	138
Maximum Resistance Unbalance		2%
Minimum Insulation Resistance (500V)	MΩ.km	5000
Nominal Capacitance @800Hz	nF/km	43
Maximum Capacitance Unbalance (pair to ground)	pF/km	1500
Mean Characteristic Impedance @100MHz	Ω	100 ± 5
Nominal Velocity of Propagation		0.76c
Maximum Propagation Delay	ns/100 m	450
Maximum Delay Skew	ns/100 m	15
Maximum Transfer Impedance @1MHz	mΩ /m	10
Maximum Transfer Impedance @10MHz	mΩ /m	8
Maximum Transfer Impedance @30MHz	mΩ /m	10
Minimum Coupling Attenuation	dB	85

### Nominal Transmission Characteristics @20°C

F MHz	Attenuation dB/100m	NEXT dB	ACR dB/100m	Return Loss dB	PS-NEXT dB	PS-ACR dB/100m	ELFEXT dB/100m	PS-ELFEXT dB/100m
1	2.0	90	88		87	85	85	82
4	3.6	90	86	27	87	83	85	82
10	5.5	90	84	30	87	81	79	76
16	7.5	90	82	30	87	79	75	72
20	7.7	90	82	30	87	79	73	70
31.25	9.8	90	80	30	87	77	69	66
62.5	14.0	86	72	30	83	69	63	60
100	17.9	83	65	30	80	62	59	56
155.0	22.4	81	59	26	78	55	57	54
200.0	25.6	78	52	25	75	49	53	50
250.0	28.8	77	48	25	74	45	51	48
300.0	31.6	73	41	23	70	38	47	44
600.0	45.7	71	25	20	68	22	44	41

### Mechanical and Thermal Properties

Bending Radius: 8 × OD (during installation); 4 × OD (fixed installed)

Temperature Range: -40°C ~ +85°C

### Dimensions and Weight

Part No.	Construction No. of elements×No. of cores in element×Cross section(mm²)	Nominal Insulation Thickness mm	Nominal Sheath Thickness mm		Nominal Overall Diameter mm	Nominal Weight kg/km
			Inner	Outer		
MLN-S/FTPCAT7M4P27S	4×2×0.27	0.47	0.75	1.0	10.1	112



### Cat 7 S/FTP 23AWG 4P/8P

#### Application

These Cat7 S/FTP cables are manufactured in accordance with IEC 61156-5 requirements, can support all Class F applications like Ethernet, Fast Ethernet, Gigabit Ethernet, suitable for voice, data, CATV and sharing application installations up to 600MHz.

#### Standards

- EN 50173-1
- EN 50288-4-1
- ISO/IEC 11801
- IEC 61156-5
- IEC 60332-1 (for LSOH & FRLSOH Sheath)
- IEC 60754-2 (for LSOH & FRLSOH Sheath)
- IEC 61034 (for LSOH & FRLSOH Sheath)
- IEC 60332-3-24 (for FRLSOH Sheath)

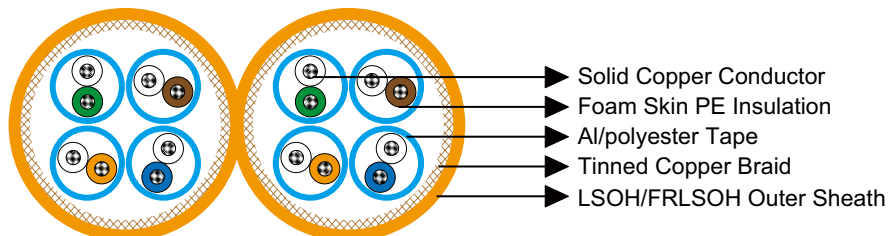
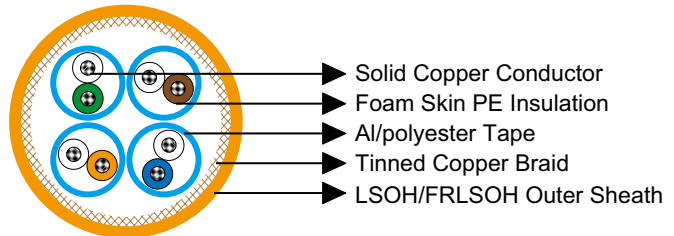

#### Approvals:

BV Certification(33493/B0 BV)

#### Construction

- Conductors: Solid bare copper conductor.
- Insulation: Foam skin PE.
- Twining: Two coloured insulated conductors twisted together to form a pair.



- Individual Screen: Al/polyester tape.
- Overall Screen: Tinned copper wire braid.
- Outer Sheath: LSOH/FRLSOH.

### Core Identification

Pair 1: White, Blue  
 Pair 2: White, Orange  
 Pair 3: White, Green  
 Pair 4: White, Brown

### Electrical Properties

Maximum Loop Resistance	$\Omega/\text{km}$	165
Maximum Resistance Unbalance		2%
Minimum Insulation Resistance (500V)	$\text{M}\Omega.\text{km}$	2000
Nominal Mutual Capacitance @800Hz	$\text{nF}/\text{km}$	43
Maximum Capacitance Unbalance (pair to ground)	$\text{pF}/\text{km}$	1500
Characteristic Impedance @1-100MHz	$\Omega$	$100 \pm 5$
Nominal Velocity of Propagation		ca. 79%
Maximum Propagation Delay	$\text{ns}/100 \text{ m}$	427
Maximum Delay Skew	$\text{ns}/100 \text{ m}$	12
Maximum Transfer Impedance @1MHz	$\text{m}\Omega / \text{m}$	5
Maximum Transfer Impedance @10MHz	$\text{m}\Omega / \text{m}$	5
Maximum Transfer Impedance @30MHz	$\text{m}\Omega / \text{m}$	10
Minimum Coupling Attenuation	$\text{dB}$	85

### Nominal Transmission Characteristics @20°C

F	Attenuation	NEXT	PS-NEXT	ACR	PS-ACR	ELFEXT	PS-ELFEXT	Return Loss
MHz	$\text{dB}/100\text{m}$	$\text{dB}$	$\text{dB}$	$\text{dB}/100\text{m}$	$\text{dB}/100\text{m}$	$\text{dB}/100\text{m}$	$\text{dB}/100\text{m}$	$\text{dB}$
1	1.8	100	97	98	95	105	105	20.5
4	3.4	100	97	97	94	105	102	27
10	5.4	100	97	95	92	97	94	30
16	6.8	100	97	93	90	93	90	30
20	7.7	100	97	92	89	91	88	30
31.2	9.6	100	97	90	87	87	84	30
62.5	13.7	100	97	86	83	81	78	30
100	17.4	100	97	83	80	77	74	30
125.0	19.5	95	92	75	72	75	72	26
155.5	21.9	94	91	72	69	73	70	26
175.0	23.3	93	90	70	67	72	69	25





# IEC Standard Caledonian Offshore & Marine Cables

## MariLan Marine Lan Data & Communication Cables

[www.caledonian-cables.co.uk](http://www.caledonian-cables.co.uk)

F	Attenuation	NEXT	PS-NEXT	ACR	PS-ACR	ELFEXT	PS-ELFEXT	Return Loss
MHz	dB/100m	dB	dB	dB/100m	dB/100m	dB/100m	dB/100m	dB
200.0	25.0	92	89	67	64	71	68	25
250.0	28.1	90	87	62	59	69	66	24
300.0	30.9	89	86	58	55	67	64	24
450.0	38.3	87	84	48	45	64	61	23
600.0	44.8	85	82	40	37	61	58	22
750.0	52.0	83	80	31	28	59	56	21
900.0	59.4	82	79	23	20	58	55	20
1000.0	63.1	80	77	17	14	57	54	20

### Mechanical and Thermal Properties

Bending Radius:  $8 \times OD$  (during installation);  $4 \times OD$  (fixed installed)

Temperature Range:  $-20^{\circ}\text{C} \sim +60^{\circ}\text{C}$

### Dimensions and Weight

Part No.	Construction No. of elements $\times$ No. of cores in element $\times$ Cross section ( $\text{mm}^2$ )	Nominal Insulation Thickness mm	Nominal Sheath Thickness mm	Nominal Overall Diameter mm	Nominal Weight kg/km
MLN-S/FTPCAT74P23	$4 \times 2 \times 23\text{AWG}$	0.41	0.75	7.5	75
MLN-S/FTPCAT78P23	$2 \times (4 \times 2 \times 23\text{AWG})$	0.41	0.75	$7.5 \times 15.0$	150



### RG Series Coaxial Cables 50 Ω/75 Ω

#### Application

These radio frequency cables are suitable for high frequency data transmission (communication equipment, radar, instrumentation equipment) and video signal transmission.

#### Standards

- MIL C 17 (RG)
- IEC 60092-360
- IEC 60332-1
- IEC 60754-1/2
- IEC 61034

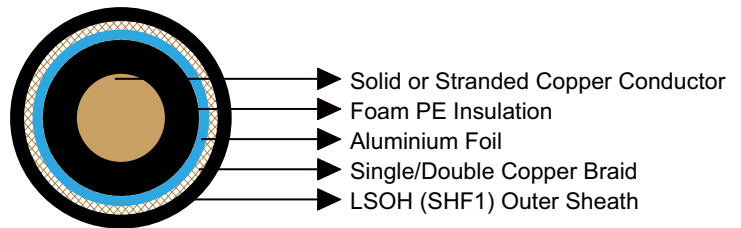

#### Construction

- Conductors: Solid or stranded TC (Tinned copper), BC (Bare copper), BCW (Bare copperweld), SC (Silvered copper) and SPCCS (Silver plated copper on steel).
- Insulation: Foam PE.
- Fire Barriers: Aluminium foil.
- Screen: Single or double braid. Bare, tinned or silvered copper.
- Outer Sheath: LSOH (SHF1).

#### Electrical Characteristics

		RG 178	RG 58	RG 174	RG 213	RG 214	RG 59	RG 223	RG 6	RG 11
Capacitance	pF/m	100	100	100	100	100	67	100	52	53
Impedance @200MHz	Ω	50 ± 2	50 ± 2	50 ± 2	50 ± 2	50 ± 2	75 ± 3	50 ± 2	75 ± 3	75 ± 3
Attenuation @50MHz	dB/100m	38	13	21	3	5	10	15	4.6	2.8
Attenuation @100MHz	dB/100m	52	21	32	7	8	14	21	6.4	4.1
Attenuation @200MHz	dB/100m	74	34	46	13	13	20	30	9.0	5.9
Attenuation @400MHz	dB/100m	108	55	82	15	22	29	39	12.8	8.5
Attenuation @1000MHz	dB/100m	170	91	147	29	39	52	68	20.8	14.3





### Mechanical and Thermal Properties

Bending Radius for Fixed Installations:  $10 \times OD$

Temperature Range:  $-30^{\circ}C \sim +60^{\circ}C$

### Dimensions and Weight

#### 50 Ω

Part No.	Cable Type	Conductor Stranding No. x mm	Conductor Diameter mm	Dielectric Diameter mm	Nominal Overall Diameter mm	Nominal Weight kg/km
MLN-RG58C	RG 58 CU	19x0.18 TC	0.90	3.0	4.95	40
MLN-RG174A	RG 174 AU	7x0.16 BCW	0.48	1.55	2.8	10
MLN-RG213U	RG 213 U	7x0.75 BC	2.25	7.3	10.3	157
MLN-RG214U	RG 214 U	7x0.75 SC	2.25	7.3	10.8	195
MLN-RG178U	RG 178 U	7x0.10 SPCCS	0.30	0.9	1.8	7
MLN-RG223U	RG 223 U	1x0.90 SC	0.90	3.02	5.38	55

#### 75 Ω

Part No.	Cable Type	Conductor Stranding No. x mm	Conductor Diameter mm	Dielectric Diameter mm	Nominal Overall Diameter mm	Nominal Weight kg/km
MLN-RG6	RG 6	1 x 1.0 BC	1.0	4.5	7.1	80
MLN-RG59	RG 59	1 x 0.57 BCW	0.57	3.75	6.15	53
MLN-RG11	RG 11	1 x 1.6 BC	1.6	7.2	10.3	135



### KX Series Coaxial Cables 50 Ω/75 Ω

#### Application

These radio frequency cables are suitable for high frequency data transmission (communication equipment, radar, instrumentation equipment) and video signal transmission.

#### Standards

- In line with MIL C17
- IEC 60092-360
- IEC 60332-3-22
- IEC 60754-1/2
- IEC 61034

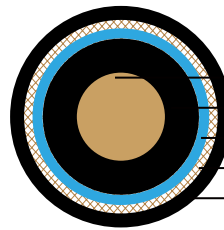

- ▶ Solid or Stranded Copper Conductor
- ▶ PE Insulation
- ▶ Aluminium Foil
- ▶ Single/Double Copper Braid
- ▶ LSOH (SHF1) Outer Sheath

#### Construction

- Conductors: Solid or stranded CCS (Bare copper plated steel), BC (Bare copper).
- Insulation: PE.
- Fire Barriers: Aluminium foil.
- Screen: Single or double braid. Bare, tinned or silvered copper
- Outer Sheath: LSOH (SHF1).

#### Electrical Characteristics

		KX 3B	KX 6A	KX 8
Characteristic Impedance	Ω	50	75	75
Capacitance	pF/m	106	72	72
Velocity	%	66	66	66
Attenuation @200MHz	dB/100m	45	20	12





### Mechanical and Thermal Properties

Bending Radius for Fixed Installations:  $10 \times OD$   
Temperature Range:  $-30^{\circ}C \sim +60^{\circ}C$

### Dimensions and Weight

#### 50 Ω

Part No.	Cable Type	Conductor Stranding No.×mm	Conductor Diameter mm	Dielectric Diameter mm	Nominal Overall Diameter mm	Nominal Weight kg/km
MLN-KX3B	KX 3B	7×0.16 CCS	0.48	1.50	2.55	10

#### 75 Ω

Part No.	Cable Type	Conductor Stranding No.×mm	Conductor Diameter mm	Dielectric Diameter mm	Nominal Overall Diameter mm	Nominal Weight kg/km
MLN-KX6A	KX 6A	7×0.20 BC	0.6	3.7	6.1	57
MLN-KX8	KX 8	7×0.40 BC	1.2	7.25	10.3	145







## PROFIBUS 1 Pair 22 AWG

### Application

These profibus cables are dedicated for fixed installation on board of ship, used as connection cables for digital signals up to 12MBd.

### Standards

- IEC 60332-1&2
- IEC 60754-1/2
- IEC 61034
- IEC 60092

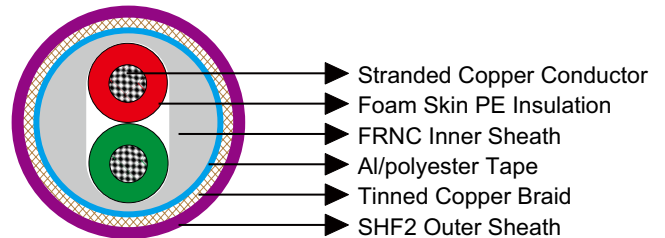

### Construction

- Conductors: Stranded bare copper 22 AWG.
- Insulation: Foam skin PE.
- Inner Sheath: Thermoplastic copolymer (FRNC).
- Overall Screen1: Aluminium/polyester tape.
- Overall Screen2: Tinned copper braid.
- Outer Sheath: SHF2.

### Core Identification

Core 1: Red  
Core 2: Green

### Electrical Characteristics

Characteristic Impedance	$\Omega$	150 $\pm$ 15
Mutual Capacitance @1KHz	nF/km	28.5
Insulation Resistance	M $\Omega$ .km	16000
Attenuation @9.6kHz	dB/km	2.5
Attenuation @38.4kHz	dB/km	4
Attenuation @4kHz	dB/km	22
Attenuation @16kHz	dB/km	42





### Mechanical and Thermal Properties

Bending Radius for Fixed Installations:  $10 \times OD$

Temperature Range:  $-25^{\circ}\text{C} \sim +80^{\circ}\text{C}$

### Dimensions and Weight

Part No.	Construction No. of elements $\times$ No. of cores in element $\times$ Cross section ( $\text{mm}^2$ )	Core Diameter mm	Nominal Overall Diameter mm	Nominal Weight kg/km
MLN- 02YSH(ST)CH-1 $\times$ 2 $\times$ 22A	1 $\times$ 2 $\times$ 22 AWG	2.55	8.0	84





### Armoured PROFIBUS 1 Pair 22 AWG

#### Application

These profibus cables are dedicated for fixed installation on board of ship, used as connection cables for digital signals up to 12MBd.

#### Standards

- IEC 60332-1&2
- IEC 60754-1/2
- IEC 61034
- IEC 60092

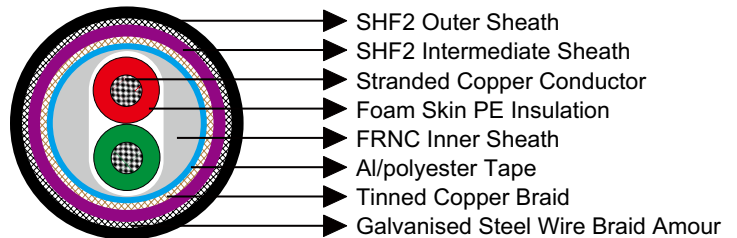

#### Construction

- Conductors: Stranded bare copper 22 AWG.
- Insulation: Foam skin PE.
- Inner Sheath: Thermoplastic copolymer (FRNC).
- Overall Screen1: Aluminium/polyester tape.
- Overall Screen2: Tinned copper braid.
- Intermediate Sheath: SHF2.
- Armour: Galvanised Steel Wire Braid.
- Outer Sheath: SHF2.

#### Core Identification

Core 1: Red  
Core 2: Green

#### Electrical Characteristics

Characteristic Impedance	$\Omega$	150 $\pm$ 15
Mutual Capacitance @1KHz	nF/km	28.5
Insulation Resistance	M $\Omega$ .km	16000
Attenuation @9.6kHz	dB/km	2.5
Attenuation @38.4kHz	dB/km	4





# IEC Standard Caledonian Offshore & Marine Cables

## MariLan Marine Lan Data & Communication Cables

[www.caledonian-cables.co.uk](http://www.caledonian-cables.co.uk)

Attenuation @4kHz	dB/km	22
Attenuation @16kHz	dB/km	42

### Mechanical and Thermal Properties

Bending Radius for Fixed Installations:  $10 \times OD$

Temperature Range:  $-30^{\circ}\text{C} \sim +75^{\circ}\text{C}$

### Dimensions and Weight

Part No.	Construction No. of elements×No. of cores in element×Cross section(mm <sup>2</sup> )	Core Diameter mm	Nominal Overall Diameter mm	Nominal Weight kg/km
MLN- 02YSH(ST)CHSWBH-1×2×22A	1×2×22 AWG	2.55	10.65	180





## PROFIBUS 1 Pair 0.35mm<sup>2</sup>

### Application

These profibus cables are dedicated for fixed installation on board of ship, used as connection cables for digital signals up to 12MBd.

### Standards

- DIN VDE 0472 part 805
- IEC 60332-1&2
- IEC 60754-1/2
- IEC 61034

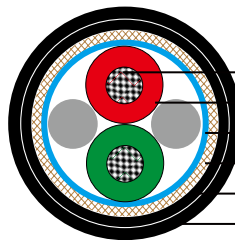

- ▶ Stranded Copper Conductor
- ▶ Foam polyethylene Insulation
- ▶ Al/polyester Tape
- ▶ Tinned Copper Braid
- ▶ Halogen-free polymer HM4 Inner Sheath
- ▶ LSOH (SHF1) Outer Sheath

### Construction

- Conductors: Stranded bare copper.
- Insulation: Foam polyethylene (cellular HDPE).
- Overall Screen1: Aluminium/polyester tape.
- Overall Screen2: Tinned copper braid.
- Inner Sheath: Halogen-free polymer HM4.
- Outer Sheath: LSOH (SHF1).

### Core Identification

Core 1: Red  
Core 2: Green

### Electrical Characteristics

Characteristic Impedance	$\Omega$	150 $\pm$ 15
Mutual Capacitance @800MHz	nF/km	30
Insulation Resistance	M $\Omega$ .km	16000
Attenuation @9.6kHz	dB/km	3
Attenuation @38.4kHz	dB/km	5
Attenuation @4kHz	dB/km	22
Attenuation @16kHz	dB/km	45



### Mechanical and Thermal Properties

Bending Radius for Fixed Installations:  $10 \times OD$

Temperature Range:  $-35^{\circ}\text{C} \sim +80^{\circ}\text{C}$

### Dimensions and Weight

Part No.	Construction No. of elements $\times$ No. of cores in element $\times$ Cross section ( $\text{mm}^2$ )	Core Diameter mm	Nominal Overall Diameter mm	Nominal Weight kg/km
MLN-02Y(ST)CH-1 $\times$ 2 $\times$ 0.35	1 $\times$ 2 $\times$ 0.35	2.75	10.3	110





## CAN BUS CABLES 120Ω

### Application

These cables are dedicated to the shipbuilding industry.

### Standards

- IEC 60092-350/352/353/360/370/376
- IEC 60332-1-2
- IEC 60332-3-22
- IEC 60754-1/2
- IEC 61034

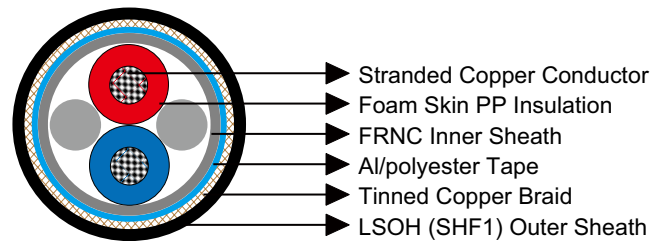

### Construction

- Conductors: Stranded tinned copper 21AWG.
- Insulation: Foam skin PP.
- Inner Sheath: Thermoplastic copolymer (FRNC).
- Overall Screen1: Aluminium/polyester tape.
- Overall Screen2: Tinned copper braid.
- Outer Sheath: LSOH (SHF1).

### Core Identification

Pair 1: Blue, Red

Pair 2: Brown, Green

### Electrical Characteristics

Characteristic Impedance	Ω	120 ± 18	
Mutual Capacitance @1KHz	nF/km	36	
Insulation Resistance	GΩ.km	5	
		1 pair	2 pair
Attenuation @0.1MHz	dB/100m	0.65	0.3
Attenuation @1MHz	dB/100m	1.9	1.1
Attenuation @5MHz	dB/100m	4.3	2.8
Attenuation @10MHz	dB/100m	8.1	3.9
Attenuation @20MHz	dB/100m	10.5	5.7





### Mechanical and Thermal Properties

Bending Radius for Fixed Installations:  $10 \times OD$

Temperature Range:  $-30^{\circ}\text{C} \sim +80^{\circ}\text{C}$

### Dimensions and Weight

Part No.	Construction No. of elements $\times$ No. of cores in element $\times$ Cross section ( $\text{mm}^2$ )	Core Diameter mm	Nominal Overall Diameter mm	Nominal Weight kg/km
MLN-09YSH(ST)CH-1 $\times$ 2 $\times$ 21A	1 $\times$ 2 $\times$ 21 AWG	2.4	7.7	79
MLN-09YSH(ST)CH-2 $\times$ 2 $\times$ 21A	2 $\times$ 2 $\times$ 21 AWG	2.2	8.4	90







## Breakout Fiber Cable

### Application

These optical fiber cables are designed to data transmission in ship and specially in cruise ship where low smoke, halogen free and flame retardant cables are required to increase safety on board, suitable for flexible installation on and below deck of commercial ships without constant exposure to oil, grease and other lubricants.

### Standards

- IEC 60092-350/352/353/360/370/376
- IEC 60332-1-2
- IEC 60332-3-22
- IEC 60754-1/2
- IEC 61034

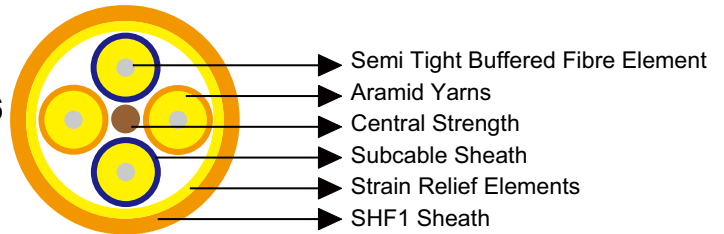

### Construction

- Optical Fiber: Semi tight buffered.
- Strain Relief Elements: Aramid.
- Subcable Sheath: Halogen-free, flame-retardant compound.
- Central Strength Member
- Separator: Taping.
- Strain Relief Elements: Aramid.
- Outer Sheath: SHF1.

### Fiber Specification

		G50/125	G62.5/125	E9/125
Geometry/Mechanical Properties				
Core Diameter	µm	50 ± 2.5	62.5 ± 3	
Mode Field Diameter (at 1310 nm)	µm			9.2 ± 0.4
Cladding Diameter	µm	125 ± 2	125 ± 1	125 ± 2
Coating Diameter	µm	245 ± 10	245 ± 5	245 ± 10
Core Non-circularity	%	< 5	< 5	
Cladding Non-circularity	%	< 1	< 1	< 1



# IEC Standard Caledonian Offshore & Marine Cables

## MariLan Marine Lan Data & Communication Cables

www.caledonian-cables.co.uk

Core/Clad Concentricity Error	μm	< 1.5		< 1.5		< 0.8	
Eccentricity of Coating	μm	< 10		< 10		< 10	
Screen Test		≥100 kpsi		≥100 kpsi		≥100 kpsi	
Transmission Properties		OM2		OM1		OS1	
Wavelength	nm	850	1300	850	1300	1310	1550
Attenuation Max.	dB/km	2.7	0.8	3.2	0.9	0.36	0.22
Bandwidth Min.	MHz. km	500	1000	250	600		
Effective Group of Refraction		1.483	1.478	1.497	1.493	1.4695	1.4701
Numerical Aperture		0.200 ± 0.015		0.275 ± 0.015			
Dispersion Coefficient Max.	ps/nm.km					3.5	18
Zero Dispersion Wavelength	nm						1300 -1322
Dispersion Slope	ps/nm <sup>2</sup> .km						≤0.092
Cutoff Wavelength (cabled)	nm						≤1250
Polarization Mode Dispersion	ps/km <sup>1/2</sup>						≤0.1

### Mechanical and Thermal Properties

Bending Radius for Fixed Installations: 15 × OD

Temperature Range: -20°C ~ +80°C

### Dimensions and Weight

Part No.	No. of Optical Fibers	Nominal Overall Diameter mm	Nominal Weight kg/km
MLN-BTA-X-2-H-F-H-CD-A	2	10.1	85
MLN-BTA-X-4-H-F-H-CD-A	4	10.1	85
MLN-BTA-X-6-H-F-H-CD-A	6	11.8	120
MLN-BTA-X-8-H-F-H-CD-A	8	13.6	160
MLN-BTA-X-10-H-F-H-CD-A	10	15.4	200
MLN-BTA-X-12-H-F-H-CD-A	12	17.2	245

Note: X: Fiber type (0=Fiber and copper conductors in cable 4=50/125 multi-mode fiber (OM3); 5=50/125 multi-mode fiber (OM2); 6=50/125 multi-mode fiber (OM1); 7=NZDS SM fiber per G.656.; 8=NZDS SM fiber per G.655.; 9=Standard SM fiber per G.652.D)



### Indoor Optical Fiber Cables with Central Strength

#### Application

These optical fiber cables are designed to data transmission in ship and specially in cruise ship where low smoke, halogen free and flame retardant cables are required to increase safety on board, suitable for flexible installation on and below deck of commercial ships without constant exposure to oil, grease and other lubricants.

#### Standards

- IEC 60092-350/352/353/360/370/376
- IEC 60332-1-2
- IEC 60332-3-22
- IEC 60754-1/2
- IEC 61034

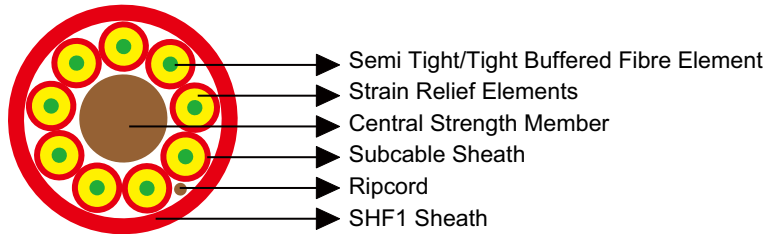

#### Construction

- Optical Fiber: Semi tight buffered or tight buffer.
- Strain Relief Elements: Aramid.
- Subcable Sheath: Halogen-free, flame-retardant compound.
- Central Strength Member
- Outer Sheath: SHF1.

#### Fiber Specification

		G50/125	G62.5/125	E9/125
Geometry/Mechanical Properties				
Core Diameter	µm	50 ± 2.5	62.5 ± 3	
Mode Field Diameter (at 1310 nm)	µm			9.2 ± 0.4
Cladding Diameter	µm	125 ± 2	125 ± 1	125 ± 2
Coating Diameter	µm	245 ± 10	245 ± 5	245 ± 10
Core Non-circularity	%	< 5	< 5	
Cladding Non-circularity	%	< 1	< 1	< 1
Core/Clad Concentricity Error	µm	< 1.5	< 1.5	< 0.8
Eccentricity of Coating	µm	< 10	< 10	< 10
Screen Test		≥100 kpsi	≥100 kpsi	≥100 kpsi
Transmission Properties		OM2	OM1	OS1



# IEC Standard Caledonian Offshore & Marine Cables

## MariLan Marine Lan Data & Communication Cables

www.caledonian-cables.co.uk

Wavelength	nm	850	1300	850	1300	1310	1550
Attenuation Max.	dB/km	2.7	0.8	3.2	0.9	0.36	0.22
Bandwidth Min.	MHz. km	500	1000	250	600		
Effective Group of Refraction		1.483	1.478	1.497	1.493	1.4695	1.4701
Numerical Aperture		0.200 ± 0.015		0.275 ± 0.015			
Dispersion Coefficient Max.	ps/nm.km					3.5	18
Zero Dispersion Wavelength	nm						1300 -1322
Dispersion Slope	ps/nm <sup>2</sup> .km						≤0.092
Cutoff Wavelength (cabled)	nm						≤1250
Polarization Mode Dispersion	ps/km <sup>1/2</sup>						≤0.1

### Mechanical and Thermal Properties

Bending Radius for Fixed Installations: 15 × OD

Temperature Range: -5°C ~ +70°C

### Dimensions and Weight

Part No.	No. of Optical Fibers	Nominal Overall Diameter mm	Nominal Weight kg/km
MLN-MTA-X-2-H-F-H-CD/VT-A	2	7.5	45
MLN-MTA-X-4-H-F-H-CD/VT-A	4	7.5	50
MLN-MTA-X-6-H-F-H-CD/VT-A	6	9.0	75
MLN-MTA-X-8-H-F-H-CD/VT-A	8	11.0	110
MLN-MTA-X-10-H-F-H-CD/VT-A	10	13.0	160
MLN-MTA-X-12-H-F-H-CD/VT-A	12	14.5	182
MLN-MTB-X-16-H-F-H-CD/VT-A	16	14.0	160
MLN-MTB-X-18-H-F-H-CD/VT-A	18	14.5	175
MLN-MTB-X-20-H-F-H-CD/VT-A	20	16.0	225
MLN-MTB-X-24-H-F-H-CD/VT-A	24	17.5	245
MLN-MTB-X-26-H-F-H-CD/VT-A	26	18.0	260

Note: X: Fiber type (0=Fiber and copper conductors in cable 4=50/125 multi-mode fiber (OM3); 5=50/125 multi-mode fiber (OM2); 6=50/125 multi-mode fiber (OM1); 7=NZDS SM fiber per G.656.; 8=NZDS SM fiber per G.655.; 9=Standard SM fiber per G.652.D)



### Tight Buffer Optical Fiber Cables

#### Application

These optical fiber cables are designed to data transmission in ship and specially in cruise ship where low smoke, halogen free and fire retardant cables are required to increase safety on board.

#### Standards

- IEC 60332-1-2
- IEC 60332-3-22
- IEC 60754-1/2
- IEC 61034

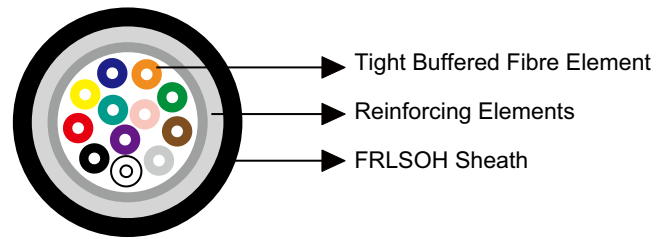

#### Construction

- Coated Optical Fiber: 250/900µm.
- Reinforcing Elements: Glass yarns with watertight tape.
- Outer Sheath: LSOH and FR compound.

#### Fiber Specification

		G50/125		G62.5/125		E9/125	
Geometry/Mechanical Properties							
Core Diameter	µm	50 ± 2.5		62.5 ± 3			
Mode Field Diameter (at 1310 nm)	µm					9.2 ± 0.4	
Cladding Diameter	µm	125 ± 2		125 ± 1		125 ± 2	
Coating Diameter	µm	245 ± 10		245 ± 5		245 ± 10	
Core Non-circularity	%	< 5		< 5			
Cladding Non-circularity	%	< 1		< 1		< 1	
Core/Clad Concentricity Error	µm	< 1.5		< 1.5		< 0.8	
Eccentricity of Coating	µm	< 10		< 10		< 10	
Screen Test		≥100 kpsi		≥100 kpsi		≥100 kpsi	
Transmission Properties		OM2		OM1		OS1	
Wavelength	nm	850	1300	850	1300	1310	1550



# IEC Standard Caledonian Offshore & Marine Cables

## MariLan Marine Lan Data & Communication Cables

www.caledonian-cables.co.uk

Attenuation Max.	dB/km	2.7	0.8	3.2	0.9	0.36	0.22
Bandwidth Min.	MHz. km	500	1000	250	600		
Effective Group of Refraction		1.483	1.478	1.497	1.493	1.4695	1.4701
Numerical Aperture		0.200 ± 0.015		0.275 ± 0.015			
Dispersion Coefficient Max.	ps/nm.km					3.5	18
Zero Dispersion Wavelength	nm						1300 -1322
Dispersion Slope	ps/nm <sup>2</sup> .km						≤0.092
Cutoff Wavelength (cabled)	nm						≤1250
Polarization Mode Dispersion	ps/km <sup>1/2</sup>						≤0.1

### Mechanical and Thermal Properties

Bending Radius for Fixed Installations: 15 × OD

Temperature Range: -20°C ~ +60°C

### Dimensions and Weight

Part No.	No. of Optical Fibers	Nominal Overall Diameter mm	Nominal Weight kg/km
MLN-MTA-X-2/4-H-VT-G	2/4	6.4	45
MLN-MTA-X-6/8-H-VT-G	6/8	7.2	52
MLN-MTA-X-10/12-H-VT-G	10/12	7.7	60

Note: X: Fiber type (0=Fiber and copper conductors in cable 4=50/125 multi-mode fiber (OM3); 5=50/125 multi-mode fiber (OM2); 6=50/125 multi-mode fiber (OM1); 7=NZDS SM fiber per G.656.; 8=NZDS SM fiber per G.655.; 9=Standard SM fiber per G.652.D)



## Central Loose Tube Optical Fiber Cables

### Application

These optical fiber cables are designed to data transmission in ship and specially in cruise ship where low smoke, halogen free and fire retardant cables are required to increase safety on board.

### Standards

- IEC 60332-1-2
- IEC 60332-3-22
- IEC 60754-1/2
- IEC 61034

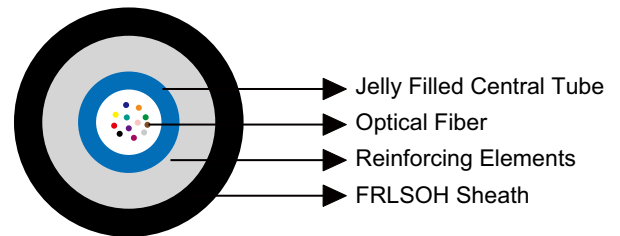

### Construction

- Central Tube: 250µm. Fully filled with thixotropic jelly.
- Reinforcing Elements: Glass yarns with watertight tape.
- Outer Sheath: LSOH and FR compound.

### Fiber Specification

		G50/125		G62.5/125		E9/125	
Geometry/Mechanical Properties							
Core Diameter	µm	50 ± 2.5		62.5 ± 3			
Mode Field Diameter (at 1310 nm)	µm					9.2 ± 0.4	
Cladding Diameter	µm	125 ± 2		125 ± 1		125 ± 2	
Coating Diameter	µm	245 ± 10		245 ± 5		245 ± 10	
Core Non-circularity	%	< 5		< 5			
Cladding Non-circularity	%	< 1		< 1		< 1	
Core/Clad Concentricity Error	µm	< 1.5		< 1.5		< 0.8	
Eccentricity of Coating	µm	< 10		< 10		< 10	
Screen Test		≥100 kpsi		≥100 kpsi		≥100 kpsi	
Transmission Properties		OM2		OM1		OS1	
Wavelength	nm	850	1300	850	1300	1310	1550



# IEC Standard Caledonian Offshore & Marine Cables

## MariLan Marine Lan Data & Communication Cables

www.caledonian-cables.co.uk

Attenuation Max.	dB/km	2.7	0.8	3.2	0.9	0.36	0.22
Bandwidth Min.	MHz. km	500	1000	250	600		
Effective Group of Refraction		1.483	1.478	1.497	1.493	1.4695	1.4701
Numerical Aperture		0.200 ± 0.015		0.275 ± 0.015			
Dispersion Coefficient Max.	ps/nm.km					3.5	18
Zero Dispersion Wavelength	nm						1300 -1322
Dispersion Slope	ps/nm <sup>2</sup> .km						≤0.092
Cutoff Wavelength (cabled)	nm						≤1250
Polarization Mode Dispersion	ps/km <sup>1/2</sup>						≤0.1

### Mechanical and Thermal Properties

Bending Radius for Fixed Installations: 20 × OD

Temperature Range: -20°C ~ +60°C

### Dimensions and Weight

Part No.	No. of Optical Fibers	Nominal Overall Diameter mm	Nominal Weight kg/km
MLN-CLA-X-1~24-H-J-G	Up to 24	8.3	78

Note: X: Fiber type (0=Fiber and copper conductors in cable 4=50/125 multi-mode fiber (OM3); 5=50/125 multi-mode fiber (OM2); 6=50/125 multi-mode fiber (OM1); 7=NZDS SM fiber per G.656.; 8=NZDS SM fiber per G.655.; 9=Standard SM fiber per G.652.D)





### Fire Resistant Central Loose Tube Optical Fiber Cables

#### Application

These optical fiber cables are designed to data transmission in ship and specially in cruise ship where low smoke, halogen free and fire resistant cables are required to increase safety on board, suitable for flexible installation on and below deck of commercial ships without constant exposure to oil, grease and other lubricants.

#### Standards

- IEC 60092-350/352/353/360/370/376
- IEC 60332-1-2
- IEC 60332-3-22
- IEC 60754-1/2
- IEC 61034
- IEC 60331-11 and -25

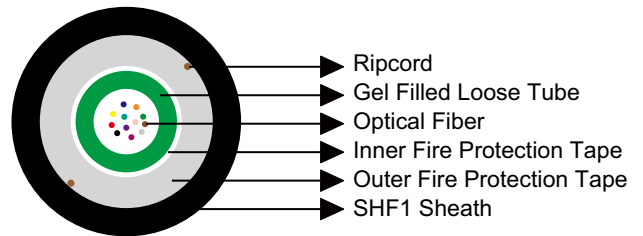

#### Construction

- Optical Fiber: Loose tube, gel filled.
- Inner Tape: Fire protection tape.
- Outer Tape: Fire protection tape.
- Outer Sheath: SHF1.

#### Fiber Specification

		G50/125	G62.5/125	E9/125
Geometry/Mechanical Properties				
Core Diameter	µm	50 ± 2.5	62.5 ± 3	
Mode Field Diameter (at 1310 nm)	µm			9.2 ± 0.4
Cladding Diameter	µm	125 ± 2	125 ± 1	125 ± 2
Coating Diameter	µm	245 ± 10	245 ± 5	245 ± 10
Core Non-circularity	%	< 5	< 5	
Cladding Non-circularity	%	< 1	< 1	< 1
Core/Clad Concentricity Error	µm	< 1.5	< 1.5	< 0.8



Eccentricity of Coating	μm	< 10		< 10		< 10	
Screen Test		≥100 kpsi		≥100 kpsi		≥100 kpsi	
Transmission Properties		OM2		OM1		OS1	
Wavelength	nm	850	1300	850	1300	1310	1550
Attenuation Max.	dB/km	2.7	0.8	3.2	0.9	0.36	0.22
Bandwidth Min.	MHz. km	500	1000	250	600		
Effective Group of Refraction		1.483	1.478	1.497	1.493	1.4695	1.4701
Numerical Aperture		0.200 ± 0.015		0.275 ± 0.015			
Dispersion Coefficient Max.	ps/nm.km					3.5	18
Zero Dispersion Wavelength	nm						1300 -1322
Dispersion Slope	ps/nm <sup>2</sup> .km						≤0.092
Cutoff Wavelength (cabled)	nm						≤1250
Polarization Mode Dispersion	ps/km <sup>1/2</sup>						≤0.1

### Mechanical and Thermal Properties

Bending Radius for Fixed Installations: 20 × OD

Temperature Range: -20°C ~ +60°C

### Dimensions and Weight

Part No.	No. of Optical Fibers	Nominal Overall Diameter mm	Nominal Weight kg/km
MLN-FCLA-X-12-H-J	12	10.0	115
MLN-FCLB-X-24-H-J	24	10.5	125

Note: X: Fiber type (0=Fiber and copper conductors in cable 4=50/125 multi-mode fiber (OM3); 5=50/125 multi-mode fiber (OM2); 6=50/125 multi-mode fiber (OM1); 7=NZDS SM fiber per G.656.; 8=NZDS SM fiber per G.655.; 9=Standard SM fiber per G.652.D)



### Caledonian Order Code

### MariTox Marine Flame Retardant Medium Voltage Cables

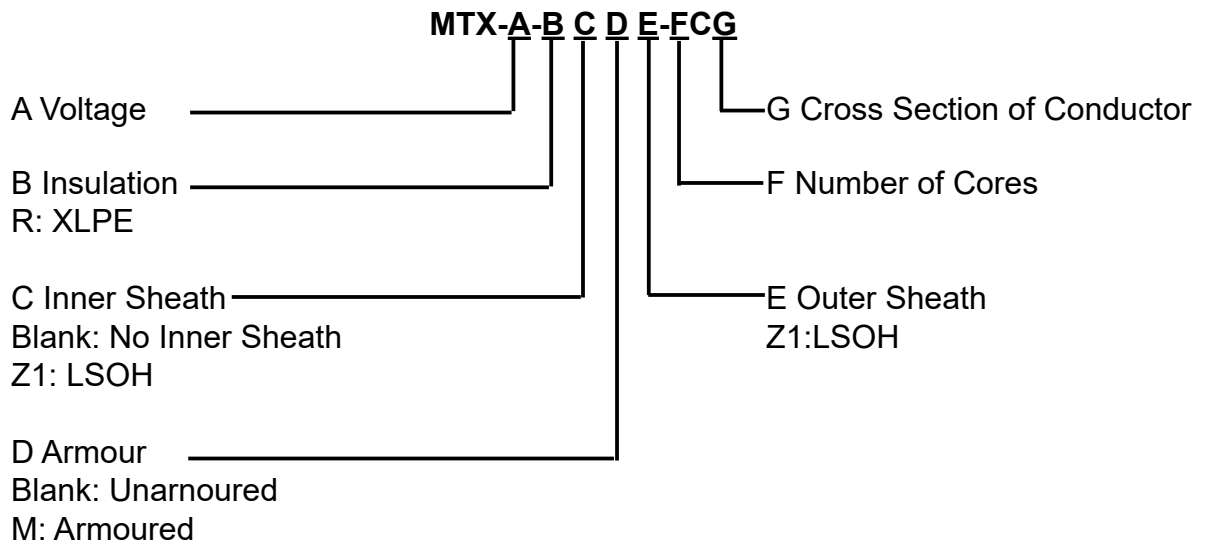

### MariTox Marine Flame Retardant Power & Control Cables

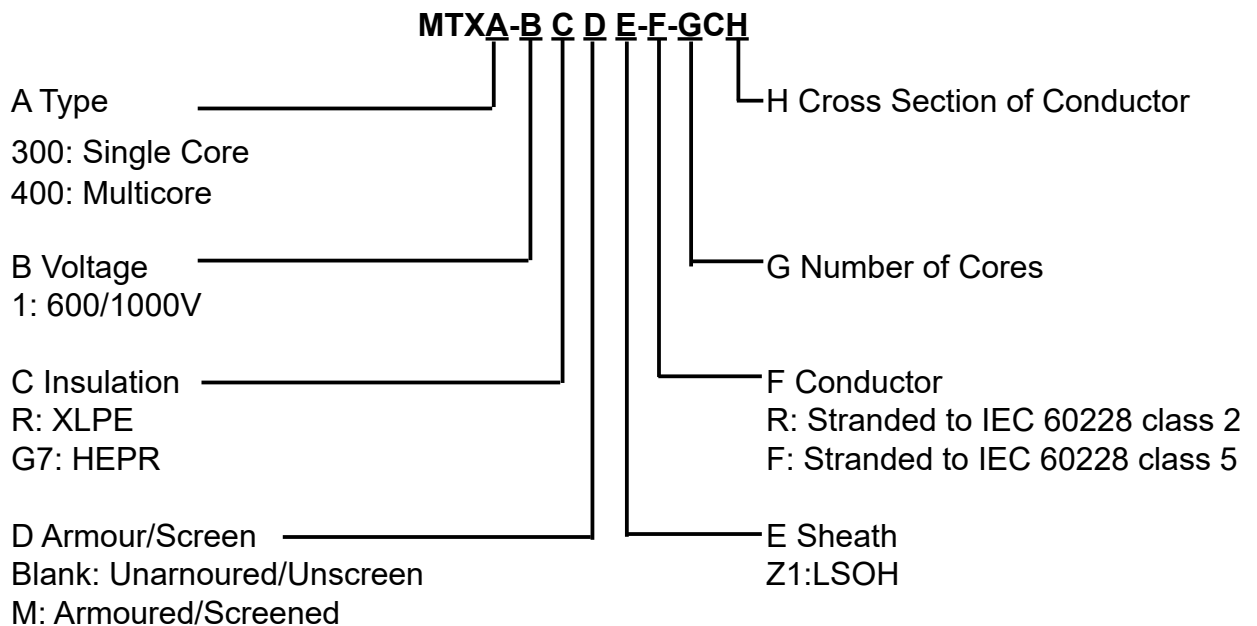



### MariFlex Marine Fire Resistant Power & Control Cables

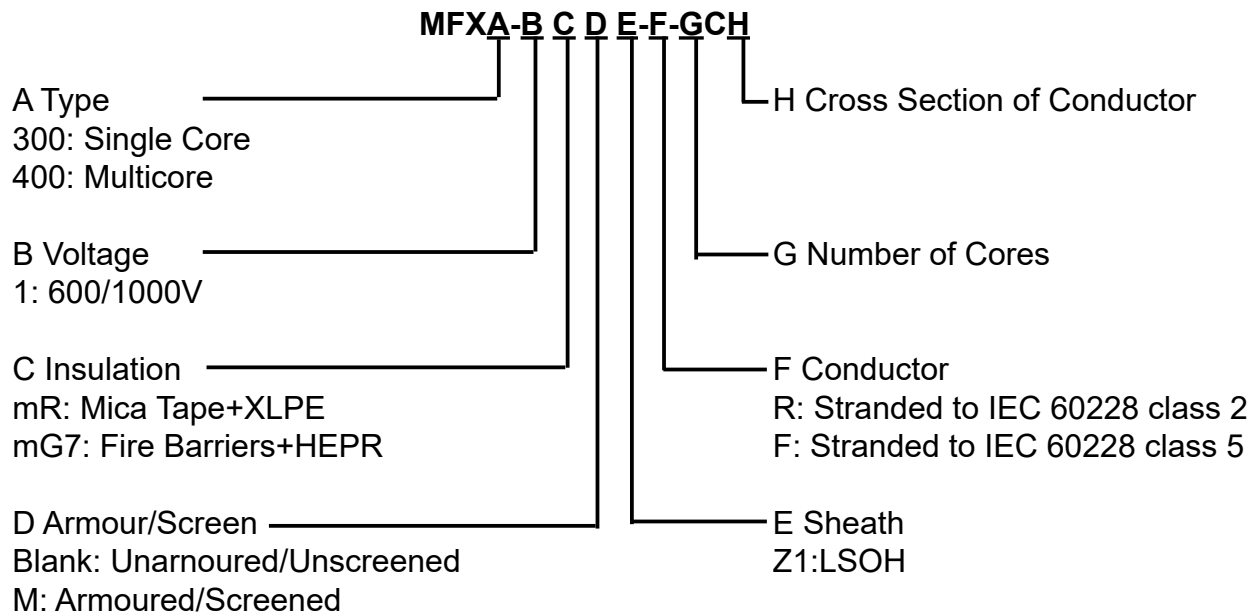

### MariSig Flame Retardant Instrumentation & Control Cables

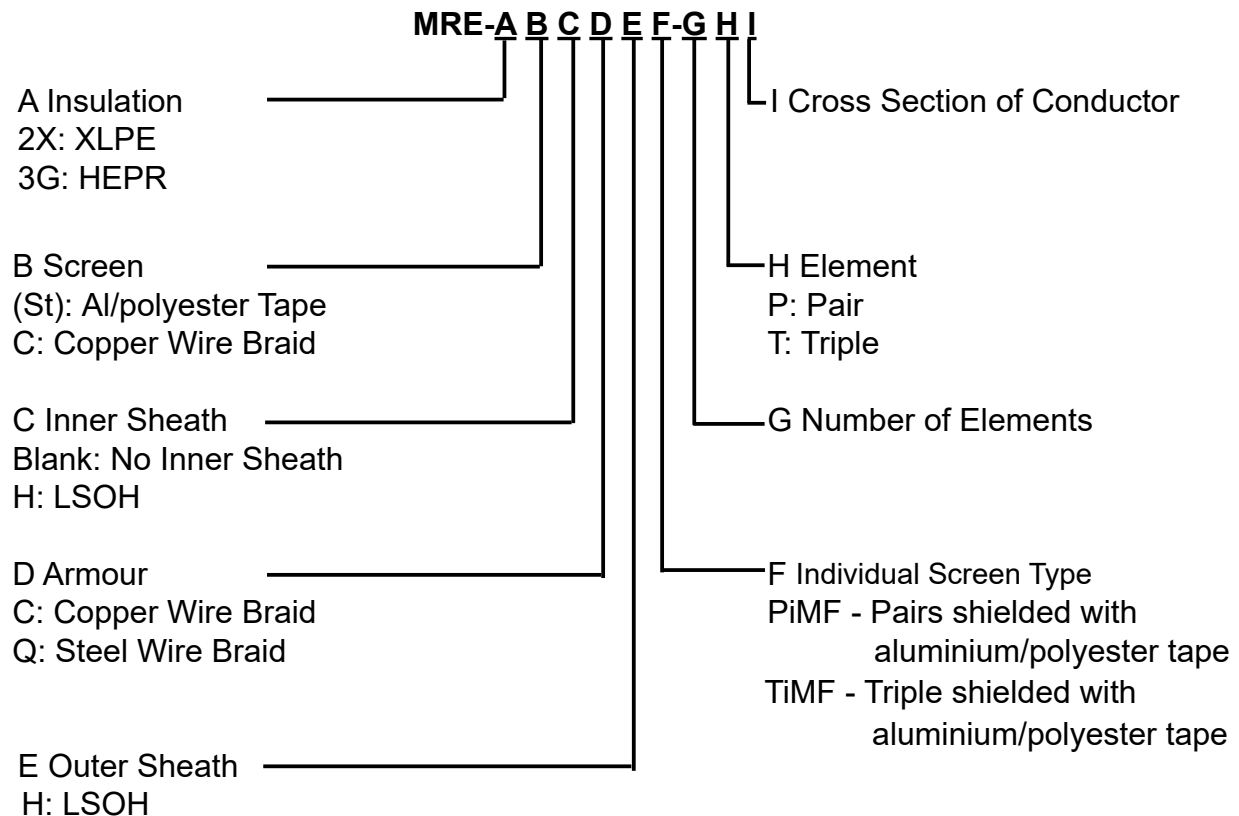



### MariSig Fire Resistant Instrumentation & Control Cables

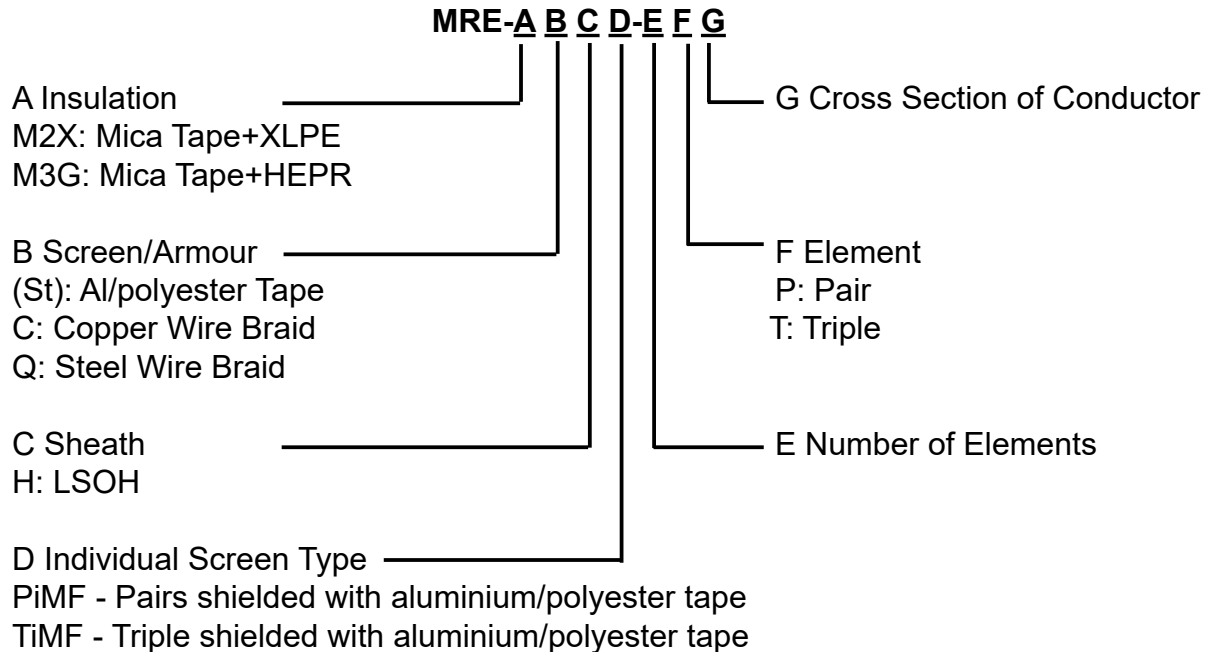

### MariLan Marine Lan Data & Communication Cables

#### LAN CABLE

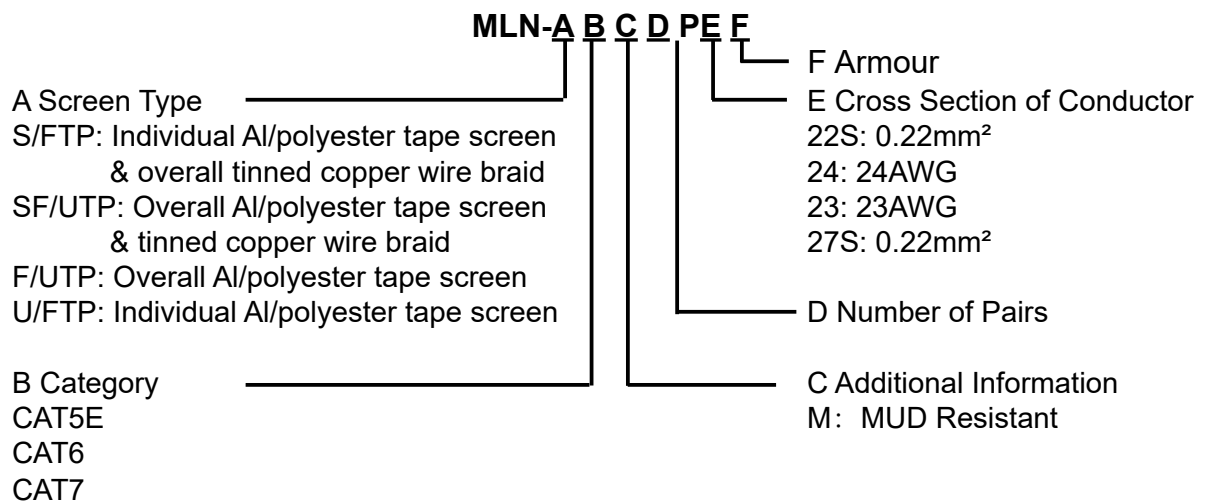

#### COAXIAL CABLE

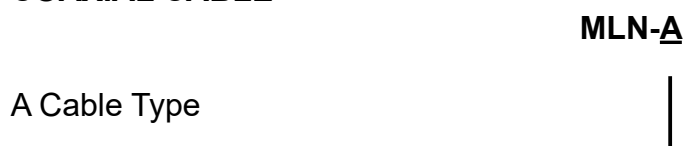

#### BUS CABLE



### MLN-A B C D E F-G×2×H

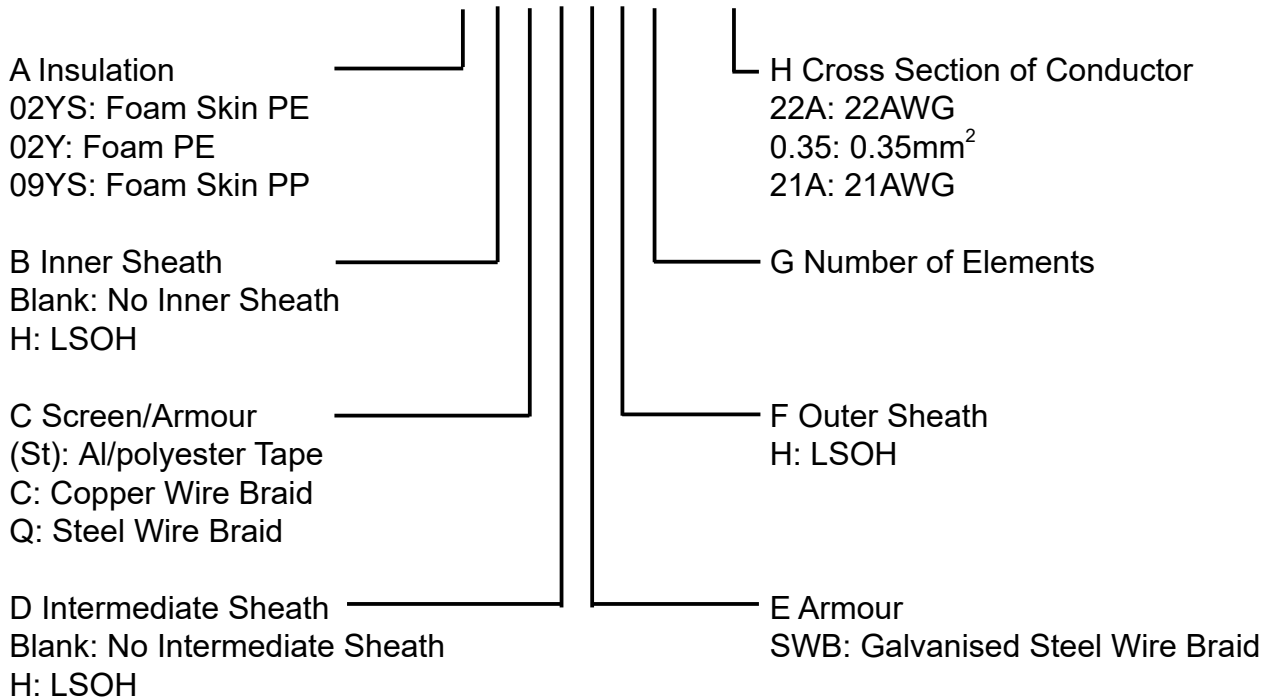

### OPTICAL FIBER CABLE

#### MLN-BTA-X-N-H-F-H-CD-A

Semi-tight buffered (CD) breakout cable (BT) with halogen free & flame-retardant subcable sheath (H), FRP central member (F), SHF1 sheath (H) and aramid strain relief elements.

#### MLN-MTA-X-N-H-F-H-CD/VT-A

Semi tight buffered (CD) or tight buffered (VT) distribution cable (MT) with halogen free & flame-retardant subcable sheath (H), FRP central member (F), SHF1 sheath (H) and aramid strain relief elements.

#### MLN-MTA-X-N-H-VT-G

Tight buffered (VT) distribution cable (MT) with LSOH & FR compound sheath (H) and fiberglass yarn reinforcing elements (G).

#### MLN-CLA-X-N-H-J-G

Central loose tube cable (CL) with water blocking gel in tubes (J), LSOH & FR compound sheath (H) and fiberglass yarn reinforcing elements (G).

#### MLN-FCLA-X-N-H-J

Fire resistant (F) central loose tube cable (CL) with water blocking gel in tubes (J) and SHF1 sheath (H).

X: Fiber type (0=Fiber and copper conductors in cable 4=50/125 multi-mode fiber (OM3); 5=50/125 multi-mode fiber (OM2); 6=50/125 multi-mode fiber (OM1); 7=NZDS SM fiber per G.656.; 8=NZDS SM fiber per G.655.; 9=Standard SM fiber per G.652.D). N: No. of Fibers.



## Power Copper Conductors According to IEC 60228

### Tinned conductors

Cross section	cl.2	cl.5	Cross section	cl.2	cl.5
mm <sup>2</sup>	Ohm/km	Ohm/km	mm <sup>2</sup>	Ohm/km	Ohm/km
1.0	18.2	20	70	0.270	0.277
1.5	12.2	13.7	95	0.195	0.210
2.5	7.56	8.21	120	0.154	0.164
4	4.70	5.09	150	0.126	0.132
6	3.11	3.39	185	0.100	0.108
10	1.84	1.95	240	0.0762	0.0817
16	1.16	1.24	300	0.0607	0.0654
25	0.734	0.795	400	0.0475	0.0495
35	0.529	0.565	500	0.0369	0.0391
50	0.391	0.393	630	0.0286	0.0292

### Plain conductors

Cross section	cl.2	cl.5	Cross section	cl.2	cl.5
mm <sup>2</sup>	Ohm/km	Ohm/km	mm <sup>2</sup>	Ohm/km	Ohm/km
1	18.1	19.5	70	0.268	0.272
1.5	12.1	13.3	95	0.193	0.206
2.5	7.41	7.98	120	0.153	0.161
4	4.61	4.95	150	0.124	0.129
6	3.08	3.30	185	0.0991	0.106
10	1.83	1.91	240	0.0754	0.0801
16	1.15	1.21	300	0.0601	0.0641
25	0.727	0.780	400	0.0470	0.0486
35	0.524	0.554	500	0.0366	0.0384
50	0.387	0.386	630	0.0283	0.0287



### Correction factors according to IEC 60228

IEC 60228 standard provides electrical resistance of copper conductors at an ambient temperature of 20° C.

For other temperatures, correction factors are applied as below:

Temperature (°C)	Kt
5	1.064
10	1.042
15	1.020
20	1.000
25	0.980
30	0.962
35	0.943
40	0.926
45	0.909
50	0.893
55	0.877
60	0.862
65	0.847
70	0.833
75	0.820
80	0.806
85	0.794
90	0.781
95	0.769
100	0.758

### Instrumentation & Control Conductors According to IEC 60092-

### 376

Cross section mm <sup>2</sup>	Tinned conductors		Plain conductors	
	cl.2 Ohm/km	cl.5 Ohm/km	cl.2 Ohm/km	cl.5 Ohm/km
0.5	41.6	42.5	40.4	41.4
0.75	26.3	28.3	26.0	27.6
1	19.3	21.2	19.2	20.7
1.5	12.9	14.5	12.8	14.1
2.5	8.02	8.71	7.56	8.47





### Current Ratings for Continuous Service (IEC 60092-352)

Conductor temperature Nominal cross-sectional Area (mm <sup>2</sup> )	90°C					
	Single core (A)		Two core (A)		Three core & four core (A)	
0.5	10		8.5		7	
0.75	13		11		9	
1	18		15		13	
1.5	23		20		16	
2.5	30		26		21	
4	40		34		28	
6	52		44		36	
10	72		61		50	
16	96		82		67	
25	127		108		89	
35	157		133		110	
50	196		167		137	
70	242		206		169	
95	293		249		205	
120	339		288		237	
150	389		331		273	
185	444		377		311	
240	522		444		366	
300	601		511		420	
	d.c.	a.c.	d.c.	a.c.	d.c.	a.c.
400	690	670	587	570	483	469
500	780	720	663	612	546	504
500	890	780	757	663	623	546

#### Note

1. Maximum permissible service temperature of the conductor is 90°C.
2. The current ratings given above are based on an ambient air temperature of 45°C.
3. The current ratings given above are for 6 cables of less bunched or laid together in flat formation. When more than 6 cables are bunched or laid close together, the current ratings given above should be multiplied by correction factor 0.85.
4. For cables with more than four core cables, the current ratings are calculated by the following formula.

$$I = I_1 / N^{1/3}$$

$I_1$ : Current for single core cable

N: Number of cores





### 5. Correction factors for various ambient air temperature

Maximum conductor temperature °C	Correction factors for ambient air temperature									
	35	40	45	50	55	60	65	70	75	80
90	1.10	1.05	1.00	0.94	0.88	0.82	0.74	0.67	0.58	0.47

## Short Circuit Current Ratings

The short circuit currents quoted here are for cables operating normally at maximum conductor temperature of 90°C.

XLPE insulation is actually capable of withstanding short-term temperature up to 250°C.

According to ICEA P-32-382 Curves based on formula:

$$I = A \times \sqrt{\frac{0.115 \log \left( \frac{T_2 + 234}{T_1 + 234} \right)}{t}}$$

I: Short circuit current (kA)

A: Conductor area (mm<sup>2</sup>)

T<sub>1</sub>: Operating temperature (85°C)

T<sub>2</sub>: Short circuit temperature (250°C)

t: Short circuit duration (sec)

**T1 = 90, T2 = 250**

Nominal Area (mm <sup>2</sup> )	Short Circuit Current(kA)													
	Duration of Short Circuit in Second													
	0.03	0.05	0.07	0.1	0.14	0.2	0.3	0.4	0.5	0.6	0.7	0.8	0.9	1.0
1.5	1.26	0.98	0.83	0.69	0.58	0.49	0.40	0.35	0.31	0.28	0.26	0.24	0.23	0.22
2.5	2.02	1.56	1.32	1.10	0.93	0.78	0.64	0.55	0.49	0.45	0.42	0.39	0.37	0.35
4	3.25	2.52	2.13	1.78	1.50	1.26	1.03	0.89	0.80	0.73	0.67	0.63	0.59	0.56
6	4.86	3.77	3.18	2.66	2.25	1.88	1.54	1.33	1.19	1.09	1.01	0.94	0.89	0.84
10	8.19	6.34	5.36	4.49	3.79	3.17	2.59	2.24	2.01	1.83	1.70	1.59	1.50	1.42
16	12.99	10.06	8.50	7.11	6.01	5.03	4.11	3.56	3.18	2.90	2.69	2.52	2.37	2.25
25	20.6	15.9	13.5	11.3	9.5	8.0	6.5	5.6	5.0	4.6	4.3	4.0	3.8	3.6
35	28.5	22.1	18.7	15.6	13.2	11.1	9.0	7.8	7.0	6.4	5.9	5.5	5.2	4.9
50	38.6	29.9	25.3	21.2	17.9	15.0	12.2	10.6	9.5	8.6	8.0	7.5	7.1	6.7
70	55.9	43.3	36.6	30.6	25.9	21.6	17.7	15.3	13.7	12.5	11.6	10.8	10.2	9.7
95	77.5	60.0	50.7	42.4	35.9	30.0	24.5	21.2	19.0	17.3	16.0	15.0	14.1	13.4
120	97.9	75.8	64.1	53.6	45.3	37.9	31.0	26.8	24.0	21.9	20.3	19.0	17.9	17.0
150	120.3	93.1	78.7	65.9	55.7	46.6	38.0	32.9	29.5	26.9	24.9	23.3	22.0	20.8
185	150.8	116.8	98.8	82.6	69.8	58.4	47.7	41.3	36.9	33.7	31.2	29.2	27.5	26.1



## Technical Information

www.caledonian-cables.co.uk

Nominal Area	Short Circuit Current(kA)													
	Duration of Short Circuit in Second													
240	198.3	153.6	129.8	108.6	91.8	76.8	62.7	54.3	48.6	44.3	41.0	38.4	36.2	34.3
300	248.7	192.6	162.8	136.2	115.1	96.3	78.6	68.1	60.9	55.6	51.5	48.2	45.4	43.1
400	329.3	255.1	215.6	180.4	152.5	127.6	104.1	90.2	80.7	73.6	68.2	63.8	60.1	57.0
500	401.0	310.6	262.5	219.6	185.6	155.3	126.8	109.8	98.2	89.7	83.0	77.7	73.2	69.5

## Reactance / Impedance

### Reactance

Conductor area(mm <sup>2</sup> ) Rating factors (Ω /km)	1.5	2.5	4	6	10	25	35	50	70	95	120	150	185	240	300
	0.135	0.125	0.117	0.111	0.103	0.098	0.097	0.094	0.091	0.090	0.088	0.088	0.088	0.088	0.087

The reactance of a cable operating in AC system depends on many factors, including, in particular, the axial spacing between conductors and proximity and magnetic properties of adjacent steelwork. The former is known for multicore cable, but may vary for single core cables depending upon the spacing between them and their disposition when installed.

Reactances of cables in certain dispositions remote from steelwork are calculable and are shown. The tabulated values are for cables with circular conductors. The value for a sector-shaped conductor should be taken as 90% of the tabulated value. The value of reactance so calculated is for a supply frequency of 60Hz. For any other frequency, a correction should be made in direct proportion to the frequency.

For example at 50Hz, the reactance is 0.83 times that at 60Hz. Induction for 2-and 3-conductor cables is given by the formula:

$$L = 0.2 \times [\ln(2a/b) + 0.25] \times 10^{-6}$$

L = Inductance in H/m and phase

a = Axial space between conductor

d = Conductor diameter in mm

Reactance for 2-and 3-conductor cables is given by the formula:

$$X = 2 \times \pi \times f \times L \times l$$

X = Reactance in ohm per phase

f = Frequency in Hz

L = Inductance in H/m and phase

l = Conductor length in meter





### Impedance

Conductor area (mm <sup>2</sup> )	1.5	2.5	4	6	10	16	25	35	50	70	95	120	150	185	240	300
Rating factors (Ω /km)	15.557	9.641	5.994	3.967	2.348	1.482	0.941	0.681	0.507	0.356	0.265	0.215	0.183	0.155	0.131	0.116

Impedance for 2, 3 & 4 conductor cables is given by the formula:

$$Z = \sqrt{(R^2 + X^2)}$$

Z = Impedance in ohm per phase

R = Resistance at operating temp. in ohm per phase

X = Reactance in ohm per phase

### Voltage Drop (Cables Up to 1 KV)

Nominal c.s.a mm <sup>2</sup>	K					
	3x1 cores (trefoil formation)		2 cores		3-4 cores	
	C.d.T. c.a. cosfi 1 mV/Am	C.d.T. c.a. cosfi 0.8 mV/Am	C.d.T. c.a. cosfi 1 mV/Am	C.d.T. c.a. cosfi 0.8 mV/Am	C.d.T. c.a. cosfi 1 mV/Am	C.d.T. c.a. cosfi 0.8 mV/Am
1			46.4	37.3	40.1	32.3
1.5			31.1	25.0	26.9	21.7
2.5			19.3	15.6	16.7	13.5
4			12.0	9.73	10.4	8.41
6			7.93	6.48	6.860	5.60
10	3.51	2.90	4.69	3.88	4.059	3.35
16	2.21	1.86	2.96	2.48	2.559	2.15
25	1.40	1.21	1.87	1.61	1.620	1.39
35	1.01	0.891	1.35	1.19	1.168	1.03
50	0.747	0.681	0.998	0.910	0.864	0.787
70	0.517	0.494	0.690	0.660	0.597	0.571
95	0.374	0.379	0.500	0.507	0.432	0.439
120	0.296	0.316	0.396	0.422	0.343	0.365
150	0.244			0.273	0.282	0.316
185	0.195			0.234	0.225	0.271
240	0.151			0.198	0.174	0.229
300	0.122			0.175	0.142	0.203



### Voltage Drop Coefficient

The voltage drop coefficients in each circuit are given in the following table

Voltage	Conductor size mm <sup>2</sup>	Voltage drop coefficient						
		100	95	90	85	80	75	70
250V	0.75	1.00	0.95	0.90	0.85	0.80	0.75	0.70
	1	1.00	0.95	0.90	0.85	0.80	0.75	0.70
0.6/1KV	1.5	1.00	0.95	0.90	0.85	0.80	0.75	0.71
	2.5	1.00	0.95	0.90	0.86	0.81	0.76	0.71
	4	1.00	0.96	0.91	0.86	0.81	0.76	0.71
	6	1.00	0.96	0.91	0.86	0.81	0.77	0.72
	10	1.00	0.96	0.92	0.87	0.82	0.77	0.73
	16	1.00	0.97	0.92	0.88	0.83	0.76	0.74
	25	1.00	0.98	0.94	0.90	0.85	0.81	0.76
	35	1.00	0.99	0.95	0.91	0.87	0.83	0.78
	50	1.00	1.00	0.97	0.93	0.89	0.85	0.81
	70	1.00	1.02	1.00	0.97	0.93	0.90	0.86
	95	1.00	1.04	1.03	1.01	0.98	0.95	0.92
	120	1.00	1.07	1.06	1.05	1.03	1.00	0.97
	150	1.00	1.09	1.10	1.09	1.08	1.05	1.03
	185	1.00	1.13	1.15	1.15	1.15	1.13	1.11
	240	1.00	1.19	1.23	1.25	1.25	1.25	1.24
300	1.00	1.24	1.31	1.35	1.36	1.37	1.37	





## **UNITED KINGDOM**

Marchants Industrial Centre,  
Mill Lane, Laughton, Lewes,  
East Sussex, BN8 6AJ, UK  
Tel: 44 (0) 207 419 5087  
Fax: 44 (0) 207 831 9489  
Email: [sales@caledonian-cables.co.uk](mailto:sales@caledonian-cables.co.uk)  
[www.caledonian-cables.co.uk](http://www.caledonian-cables.co.uk)

## **HONG KONG**

Unit B 22/F CMA Building,  
64-66 Connaught Road Central,  
Hong Kong  
Tel: 852 36527508  
Fax: 852 35834834  
Email: [hk@caledonian-cables.co.uk](mailto:hk@caledonian-cables.co.uk)  
[www.caledonian-cables.co.uk](http://www.caledonian-cables.co.uk)